

Applications

From rugged mining conditions to sensitive pharmaceuticals, from the food sector to the ATEX requirements, from lowest residual moisture to optimum cake washing: ANDRITZ can provide extensive references, with more than 10,000 presses supplied.

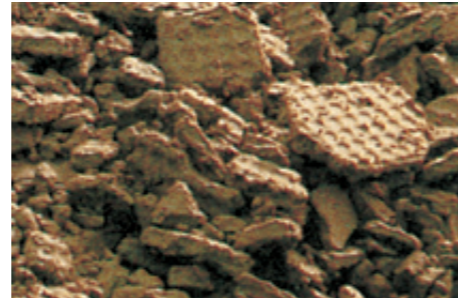

Chemicals and pigments



Industrial and municipal wastewater treatment



Metallurgical products and ores



Food and pharmaceuticals

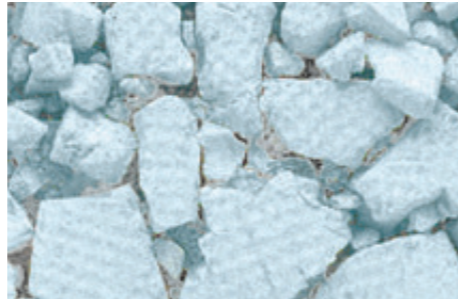

Minerals and inorganic products, Mining

Overhead filter presses for demanding applications



NORTH AMERICA
ANDRITZ SEPARATION Inc.
Phone: +1 (817) 465 5611
Fax: +1 (817) 468 3961
separation.us@andritz.com

EUROPE
ANDRITZ AG
Phone: +43 (316) 6902 2990
Fax: +43 (316) 6902 92990
separation@andritz.com

CHINA
ANDRITZ (China) Ltd.
Phone: +86 (757) 6663 3419
Fax: +86 (757) 6663 3448
separation.cn@andritz.com

AFRICA
ANDRITZ Delkor (Pty) Ltd
Phone : +27 (11) 466 2361
Fax : +24 (86) 636 2122
separation.za@andritz.com

SOUTH AMERICA
ANDRITZ SEPARATION Ltda.
Phone: +55 (47) 3387 9110
Fax: + 55 (47) 3387 9103
separation.bra@andritz.com

ASIA
ANDRITZ Singapore Pte. Ltd.
Phone: +65 (6512) 1800
Fax: +65 (6863) 4482
separation.sg@andritz.com

AUSTRALIA
ANDRITZ Pty. Ltd.
Phone: +61 (3) 8773 4888
Fax: +61 (3) 8773 4899
separation.au@andritz.com

www.andritz.com

ANDRITZ overhead filter presses

Leading for demanding applications

As a result of its acquisition of R&B and Netzsch Filtrationstechnik, ANDRITZ has become the leading supplier worldwide of high-quality design filter presses used in the municipal and the industrial sectors.

ANDRITZ has supplied over 10,000 presses so far and thus has extensive filtration know-how. The product range comprises chamber and membrane filter presses up to a size of 2450 x 2450 mm and an area of 2000 m². The filtration pressures range from 7 to 60 bar.

Main areas of application for overhead beam filter presses

- aggressive media
- high throughputs per machine
- free access required to plate pack

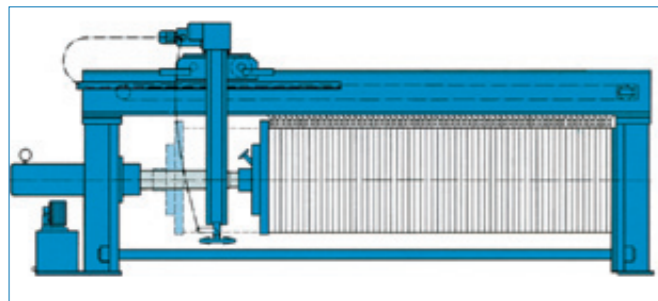

„Push to close“ cylinder for plate formats up to 2000 x 2000 mm and filtration pressures up to 60 bar

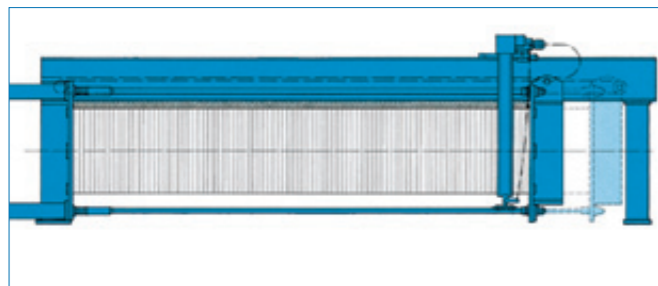

„Pull to close“ cylinders for plate formats up to 2450 x 2450 mm and filtration pressures up to 50 bar



Options

Fully automatic filter cloth cleaning system

- wash pressure up to 100 bar
- effective sealing against splash

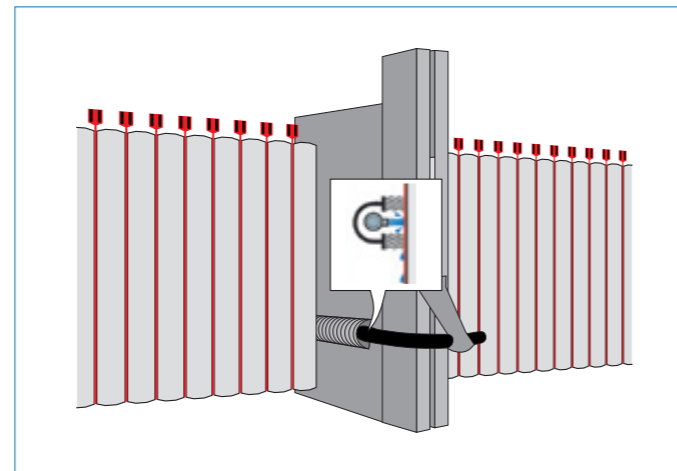

All parts in contact with the product are rubber-covered for aggressive applications, e.g. recycling of dilute acid



Your benefit

- low residual moisture
- high capture rate
- low energy requirement
- reliable, fully automatic operation
- solid and robust design for demanding operating conditions
- long service life
- high operating availability
- free access to plate pack
- special design for aggressive media
- customer-oriented process solution thanks to modular design

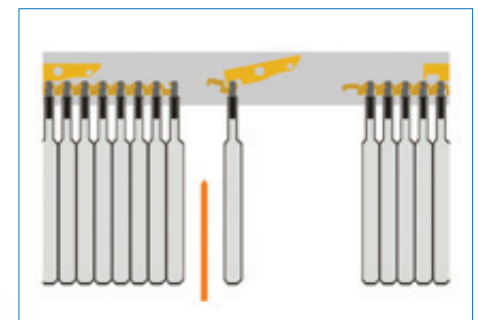

Revolving chain with plate interlocking for rapid opening of the presses

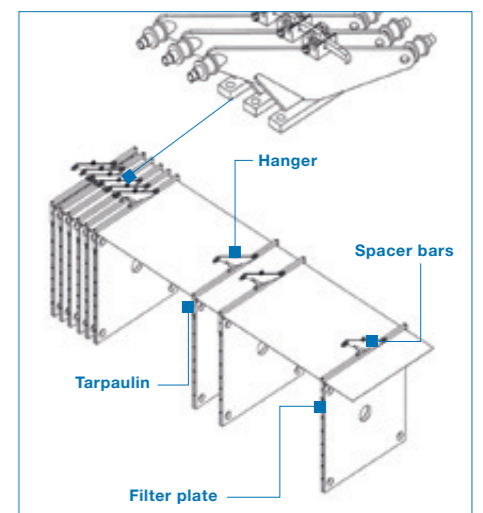

The special plate suspension system (spacer bars and cross-beam) and the tarpaulin over the plate protects the plate transport mechanism of the overhead beam machine, keeping it clean and guaranteeing fault-free operation.