

GRUNDFOS PLUMBING & HVAC PRODUCTS



SERIES UP CIRCULATORS

GRUNDFOS CIRCULATORS FOR HEATING AND HOT WATER RECIRCULATION

- Quiet, maintenance-free performance
- Stainless steel construction, corrosion resistant
- Low energy consumption
- Built-in motor protection for long life
- Versatility with multiple fittings
- UL/CSA listed

Grundfos Series UP circulators are engineered to meet the demands of residential hot water and heating systems applications. You will find Grundfos wet rotor circulators at work in a variety of open and closed loop applications:

Hydronic and fan coil heating – offering individual temperature control through select hot water zoning loops.

Hot water recirculation systems – offers potable water heating and water conservation (see back panel).

Solar heating – providing efficient alternatives for residential hot water applications.

Radiant heating systems – providing hot water for heating through floor-installed zoning loops.

Grundfos circulators provide extremely quiet performance for various domestic hot water systems. The automatic resetting thermal (impedance) protection assures integrated motor protection, low maintenance and longer life. Circulator housings are designed in stainless steel, cast iron, bronze and composite for numerous applications of open and closed loop systems. Grundfos circulators are reliable and durable.



UP 15-42 BUC5/MR
UP 15-42 BUC7/MR
UP 15-42 FC/MR
UP 43-64 BFC/MR



UP 15-42 F/VS
UP 26-96 F/VS
UP 26-64 F/VS



UP 10-16 B/B5
UP 10-16 BU



UP 15-10 B5 & 7/TLC
UP 15-18 B5 & 7/TLC
UP 15-42 B5 & 7/TLC



UP 26-64 F
UP 26-96 F
UP 26-99 F
UP 26-116 F

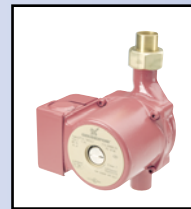

UP 15-18 BUC5 & 7
UP 15-42 BUC5 & 7



UP 50-75 F



UP 43-75 F & BF



UP 15-42 BRUTE II



UP 15-10 BUC5 & 7
TLC



UP 26-96 BF
UP 26-99 BF



UP 15-10 B5 & 7
UP 15-18 B5 & 7
UP 15-42 B5 & 7



UPS 15-42 F
3 SPEED



UP 15-18 SU
UP 15-42 SU
UP 25-64 SU



UP 15-18 SF
UP 15-42 SF
UP 25-64 SF



UP 15-18 SU/TLC

Common Applications: Boiler/Hydronic Heating • Chilled Water • Circulation • Domestic Hot Water • Fluid Transfer • Glycol Solutions • Ground Source Heat Pumps • Heat Pumps • Hot Water Recirculation • Hot Water Air Handling • Industrial • Radiant Floor Heat • Solar

Cast Iron Flanges for:

Brute II (UP15-42F) • UPS15-42F • UP26-64F • UP26-96F
 • UP26-99F • UP43-75F • UP50-75F • UP26-116F



Threaded
 (Special 2" for UP50-75F)



Threaded
 3/4" • 1" • 1-1/4" • 1-1/2"
 (Special 1-1/2" for UP43-75F)



UP 15-10 B5 & 7/TLC
 UP 15-18 B5 & 7/TLC
 UP 15-42 B5 & 7/TLC

These wet rotor circulators feature built-in timers and line cords. These circulators come standard with either 1/2" or 3/4" sweat connections. This UL approved model is reliable and efficient.

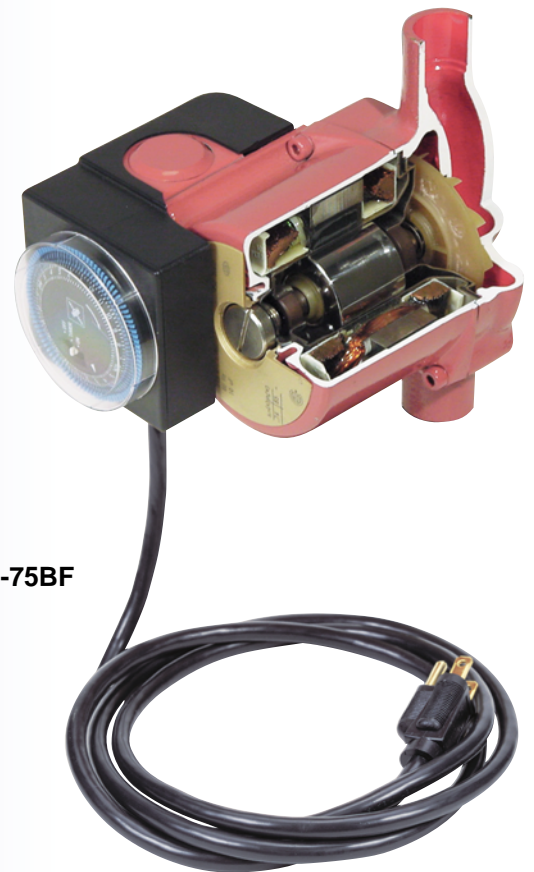

Bronze Flanges for:

UP15-18SF • UP15-42SF • UP25-64SF • UP26-96BF
 UP26-99BF • UP43-75BF

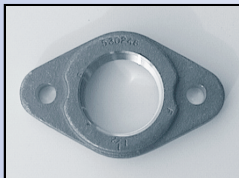

Threaded
 3/4" • 1"
 (Special 1-1/2" for UP43-75BF)

Isolation Valves for:

UP15-18SF • UP15-42SF • UP25-64SF • UP26-96BF • UP26-99BF • UP43-75BF

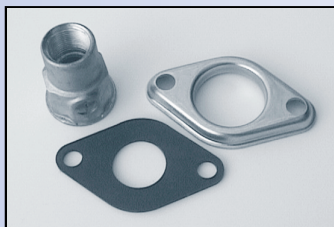

(Threaded)
 3/4" • 1" • 1-1/4"
 (Special 1-1/2" for UP43-75F)

Isolation Valves & Half Union Fittings for:

UP15-18SU • UP15-42SU • UP25-64SU



Bronze Union
 Isolation Valve
(Compression)
 3/4"

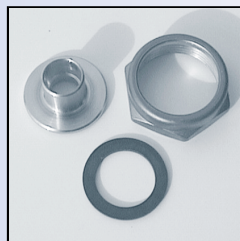

Bronze Half Union
(Sweat)
 1/2" • 3/4"



Bronze Half Union
(Threaded)
 3/4"



Bronze Half Union
 Isolation Valve
(Threaded)
 1/2" • 3/4"

CIRCULATING PUMPS FOR INDOOR HEATING AND WATER CIRCULATING SYSTEMS

- Industry standard flange-to-flange dimensions
- Built-in motor protection for long life
- Quiet, maintenance free performance
- UL/CSA listed

Grundfos VersaFlo® UPS pumps are a whole new generation in pumps.

The new VersaFlo® UPS pumps offer:

New Terminal Box

- Three-speed control.
- Fiber optic operation display.
- Pump speed selection displayed through an indicator window.

New Convergent Vane Impeller

- The revolutionary and newly designed Grundfos convergent vane impeller provides optimum efficiency and lower operating cost.
- Performance and efficiency in flow rates up to 270 gpm.
- Stainless steel construction for long-life and maintenance-free operation.

New Design

- The VersaFlo® UPS was designed with industry standard flange-to-flange dimensions to ensure trouble-free retrofitting to other competitive models.
- The wet rotor design provides whisper-quiet operation. The VersaFlo® UPS is the only wet rotor pump of its size in the industry.

Other Features of the VersaFlo® UPS

- Improved air venting.
- Expanded fluid temperature ranges from 14°F to 230°F.
- Available in cast iron and bronze models.
- Designed to be maintenance-free (no external bearing lubrication required).
- Incorporates thermal protection.



New Protection Module allows pump to be connected directly to a starter switch as it will be protected by the built-in overload protection at all three speeds.

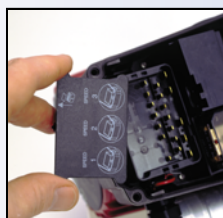

New heavy duty three-speed plug design and increased terminal box size for easy access.

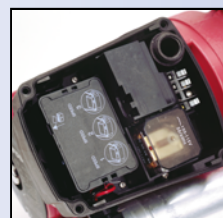

Spring clamp connectors for easy wire installation.



Fiber optic operation display and speed indicator window with control box.



Model Range

Models	HP Range	Suction and Discharge Size
UPS 32	1/3, 1/2, 3/4	1 1/4", 1 1/2"
UPS 40	1/3, 1/2, 3/4, 1 1/2	1 1/2"
UPS 50	1/3, 3/4, 1 1/2, 2	2"
UPS 80	1/2, 1 1/2, 3	3"
UPS 100	1	4"

Materials of Construction

Description	Material
Impeller, Bearing Plate, Rotor Cladding Bearing Retainers, Rotor Impeller, Rotor Can	AISI 304 SS
Impeller Seal Ring	AISI 304 SS/Teflon®
Inspection/Vent Screw, Shaft (cast iron pumps) Split Cone, Split Cone Nut	AISI 303 SS
Shaft (bronze pumps)	AISI 316 SS
Shaft Bearing Journals	Tungsten Carbide
Pump Housing* *Bronze - Optional	Cast Iron ASTM GG25 35B-40B
Stator Housing	Aluminum AISI 10Cu2
Rotor End Caps	Copper or Brass
Upper and Lower Radial Bearings	Ceramic Al2O3
Thrust Bearing	Carbon MY106
O-Rings	EPDM
Terminal Box, Nameplate	Composite PA66
Plug for Sensor	Composite PPS, GF40

Teflon® is a registered trademark of Dupont.

Common Applications: Commercial Boiler/Hydronic Heating • Chilled Water • Cooling Towers • Geothermal Systems • Water Circulation • Heat Exchangers • HVAC • Heat Pumps • Glycol Solutions • Radiant Floor Heating • Solar • Snow Melting • Greenhouse/Nurseries • Fountains • Domestic Hot Water

- Industry standard flange-to-flange dimensions
- Quiet, maintenance-free performance
- ODP or TEFC motor flexibility

Grundfos VersaFlo® TP pumps are a whole new generation of pumps.

New Convergent Vane Impeller

- Provides optimum efficiency and lower operating costs.
- Performance and improved efficiency in flow rates up to 300 gpm.
- Stainless steel construction for long-life and maintenance-free operation.

New Design

- The VersaFlo® TP was designed with drop-in-place retrofit installation in mind.
- The industry standard flange-to-flange dimensions ensure trouble-free retrofitting to other competitive models in this class.
- Expanded fluid temperature ranges from 5°F to 288°F.
- Available in either cast-iron or bronze.



New convergent vane impeller

Model Range Models	HP Range	Suction and Discharge Size
TP 32	1/3, 1/2, 3/4	1 1/4", 1 1/2"
TP 40	1/3, 3/4, 1 1/2	1 1/2"
TP 50	1/3, 3/4, 1 1/2, 2	2"
TP 80	1/2, 1 1/2, 3	3"
TP 100	1, 2, 3	4"

Materials of Construction

Description	Material
Impeller Seal Ring	AISI 304 SS/Teflon®
Impeller, Sealing Plate, Split Cone, Coupling Guard, Distributing Cup	AISI 304 SS
Pump Shaft	AISI 431 SS
Split Cone Nut	AISI 430F SS
Pump Housing*, Motor Stool*, Coupling Halves	Cast Iron ASTM GG25 *Bronze - Optional (35B-40B)
Mechanical Shaft Seal	- Stationary Face Carbon - Rotating Face Tungsten Carbide - O-Rings EPDM - Seal Drivers AISI 316 SS - Spring AISI 316 SS - Bellows EPDM
Motor Stool O-Ring	EPDM
Air Vent Screw	Brass
Plug for Sensor	Composite PPS, GF40
Pipe Plug for Flange	Steel/AISI 304 SS in bronze pumps

Teflon® is a registered trademark of Dupont.

- Direct-coupled to standard NEMA-C face motor
- Self-adjusting stainless steel and tungsten carbide/carbon shaft seal
- Stainless steel impeller and seal ring

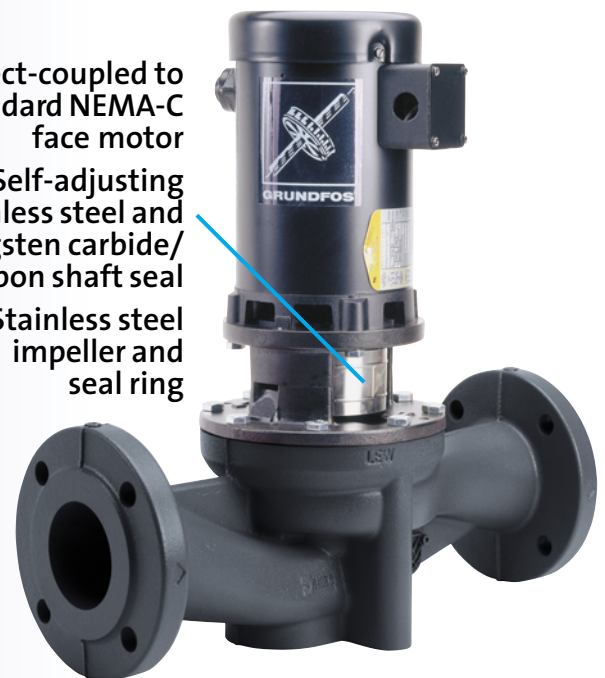

Common Applications: Commercial Boiler/Hydronic Heating • Chilled Water • Cooling Towers • Geothermal Systems • Water Circulation • Heat Exchangers • HVAC • Heat Pumps • Glycol Solutions • Radiant Floor Heating • Solar • Snow Melting • Greenhouse/Nurseries • Fountains • Domestic Hot Water

SERIES L

BOOSTER PUMPS FOR COMMERCIAL AND INDUSTRIAL HEATING AND COOLING APPLICATIONS

Grundfos Series L stainless steel fitted booster pumps are engineered for easy, no-shim installation, and have a space-saving compact footprint.

Featuring

- High-grade stainless steel pump shaft
- Neck-ring and impeller

Design

- Maintenance-free
- Low starting torque and high operating efficiency.
- Corrosion-resistant shaft seal faces are tungsten carbide/tungsten carbide for reliable performance in open or closed systems in temperature ranges of 5° to 250°F.

The Series L operates at heads up to 180 feet and flows to 600 gpm. Models are offered in 1750 and 3450 RPM. Standard NEMA-C face motors simplify installation and allow for a broad application range.

Model Range Models	HP Range	Suction and Discharge Size
2.5 LM 5/6/8	1/2, 3/4, 1, 2, 3, 5	2 1/2"
3.0 LM 5/6/8	1, 1 1/2, 2, 3, 5, 7 1/2	3"
2.5 LP	5, 7 1/2	2 1/2"
3.0 LP 5/6	5, 7 1/2, 10, 15, 20	3"
4.0 LP 5	7 1/2, 10, 15, 20	4"

Materials of Construction

Description	Material
Pump Shaft	AISI-431 SS
Impeller, Impeller Wear Ring, Coupling Guards, Impeller Seal Ring, Impeller Locking Nut and Washer	AISI 304 SS
Pump Housing, Motor Stool and Coupling	Cast Iron
Housing O-rings	EPDM-Rubber
Air Vent Screw	Brass
Mechanical Shaft Seal	EPDM
Rubber Bellows	Carbon
Stationary Seal Face	Tungsten Carbide
Rotating Seal Face	AISI-304 SS
Mechanical Seal Spring	



The compact, in-line design of the Series L simplifies piping and features a space-saving footprint.

- Direct-coupled to standard NEMA-C face motor
- 431 stainless steel pump shaft
 - High quality stainless steel shaft seal and impeller



Common Applications: Boiler/Hydronic Heating • Chilled Water • Circulation • Cooling Towers • Fluid Transfer • Fountains • Glycol Solutions • Greenhouse • Ground Source Heat Pumps • Heat Pumps • Hot Water Recirculation • HVAC • Industrial • Marine Service • Paint Booth • Process Water • Quench Water

PRODUCT LINE (UP,UPS,TP,LM/LP) PERFORMANCE CURVES

Series UPS-Performance Range

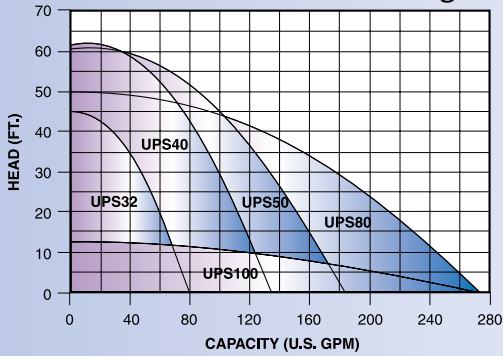

Series TP Performance Range

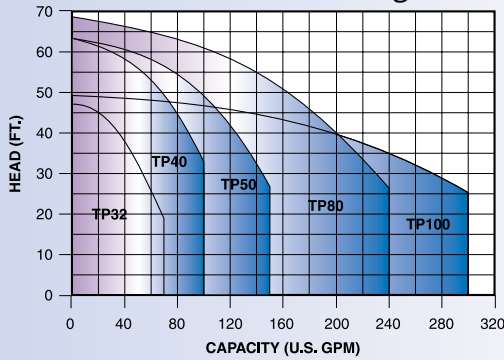

Series LM/LP Performance Range

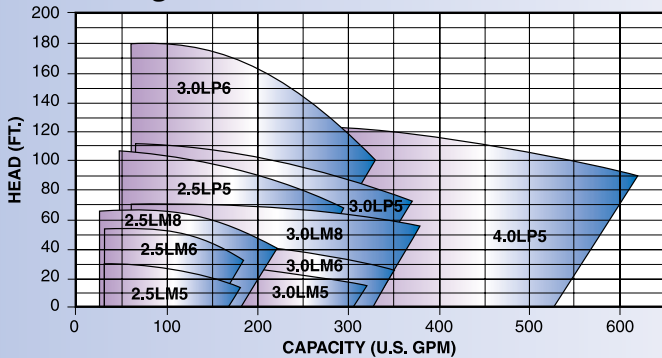

Series Comfort Performance Range

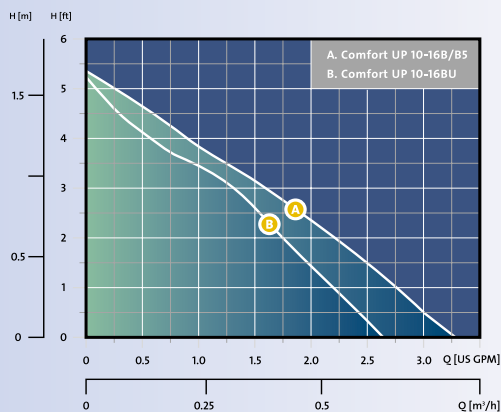

Series UP-Performance Range

Closed Systems 60 Hz

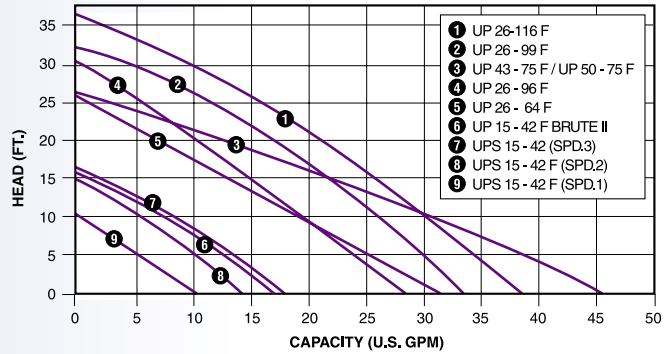

Open Systems 60 Hz

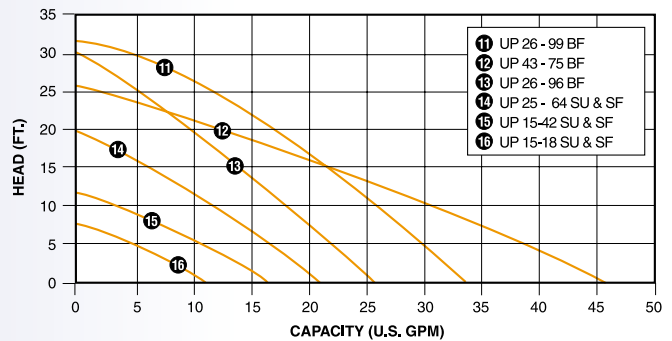
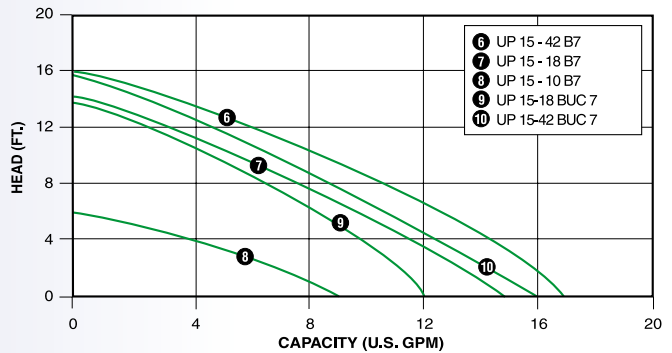
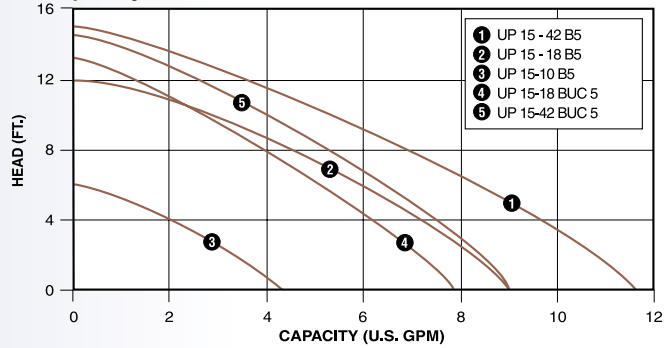

NOTE: Performance curves and technical information listed as a range only and subject to change without notice. Consult a Grundfos product submittal data sheet for exact pump specifications.

Products At-A-Glance	CAPACITY IN U.S. GPM	TOTAL HEAD IN FEET	HP	TEMP. RANGE*	MAX. WORKING PRESS.
Series UP Circulators	0 - 46	0 - 37	1/25 - 1/6	32°F - 230°F	145 PSI
Series VersaFlo UPS-Pumps	9 - 270	1 - 62	1/3 - 3	14°F - 230°F	145 PSI
Series VersaFlo TP-Pumps	8 - 300	3.5 - 67.5	1/3 - 3	5°F - 288°F	145 PSI
Series L Pumps	30 - 600	8 - 180	3/4 - 20	5°F - 250°F	175 PSI

*The UP15 has a minimum water temperature range down to 36°F.

GRUNDFOS PUMPS FOR HOT WATER RECIRCULATION

WHY INSTALL A HOT WATER RECIRCULATION SYSTEM?

• Hot Water on Demand Convenience

Hot water recirculation systems are routinely installed in hotels and other commercial buildings. Guests and building occupants not only appreciate instant hot water but have come to expect it. Residential customers can enjoy the convenience of instant hot water with proper system design and quality components.

• Water Conservation

Water conservation is an important part of all of our lives. Not only do we pay for the water coming in, but we also pay for it when it goes down the drain to our sewage systems. With hot water recirculation, the waste of valuable water becomes minimal.

• Energy Savings

When hot water sits for a long period of time in a pipe, it cools down. This water is then drained and wasted while waiting for hot water from the water heater. Every time the water sits for longer periods of time, allowing this water to cool, the energy that was used to heat that water is wasted.

With the Grundfos hot water recirculation pump, in conjunction with insulated piping, system timer, and AquaStat heat sensor, the waste of energy is minimized.

SYSTEM COMPONENTS

Typical Hot Water Recirculation System

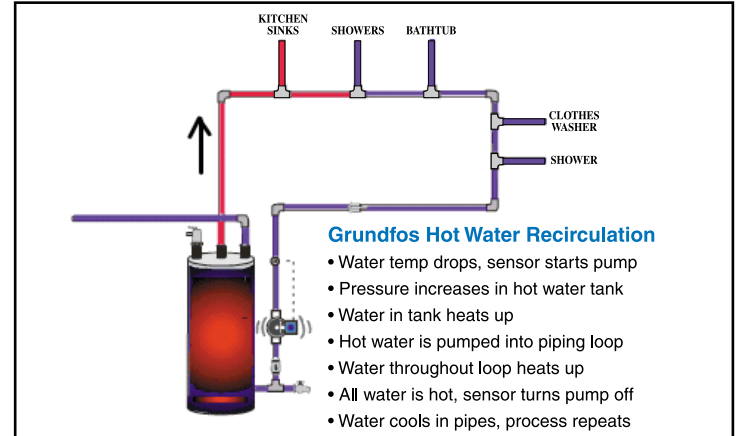

Hot Water Recirculation Accessories



Models Available for Hot Water Recirculation

Standard Models	Line Cord Models	Timer and Line Cord Models	Comfort Models
UP15-10B5	UP15-18BUC5	UP15-10B5/LC	UP10-16B5/LC
UP15-10B7	UP15-18BUC7	UP15-18B5/LC	UP10-16B5/TLC
UP15-18B5	UP15-42BUC5	UP15-18B7/LC	UP10-16B5/ATLC
UP15-18B7	UP15-42BUC7	UP15-42B5/LC	UP10-16BN5/LC
UP15-42B5	UP15-18SU	UP15-42B7/LC	UP10-16BN5/TLC
UP15-42B7	UP15-42SU	UP15-10BUC5/LC	UP10-16BN5/ATLC
UP15-10BUC5	UP25-64SU	UP15-10BUC7/LC	UP10-16BU/LC
UP15-10BUC7	UP15-10B5/LC	UP15-18SU/LC	UP10-16BU/TLC
			UP10-16BU/ATLC

www.hotwaterrecirc.com

Available from:

Performance curves and technical information listed as a range only and subject to change without notice. Consult a Grundfos product submittal data sheet for exact pump specifications. VersaFlo® and Brute IP® is a registered trademark of Grundfos Pumps Corporation.

L-PH-SL-001 Rev. 9/01
PRINTED IN USA

