



## Axial Flow Fans

- Direct Driven
- Belt Driven

**Air in Motion.**  
Wolter Fans.

**A09**



# Table of Content



Contents	Page 1
Fan Type Code	Page 2
Design Features	Page 2
Fan Selection and Installation	Page 4
Selection Sample	Page 4
AMCA FEG Rating - 50Hz	Page 5
Fan Performance Curves - 50Hz	Page 6 ~ 73
Fan FEI Curves - 50Hz	Page 74 ~ 97
AMCA FEG Rating - 60Hz	Page 98
Fan Performance Curves - 60Hz	Page 99 ~ 166
Fan FEI Curves - 60Hz	Page 167 ~ 190
Dimensions	Page 191 ~ 193
Accessories	Page 194
Acoustic Data	Page 195
Relative Frequency Spectrum	Page 196 ~ 200
Tubular sound attenuator	Page 201 ~ 202

Subject to change without prior notice.

# Axial Flow Fans

## Technical Information

AXV

### Fan type code

AXV 450 - 110 - 6 / 20° LH1 - 2 DD SU 400°C/2Std

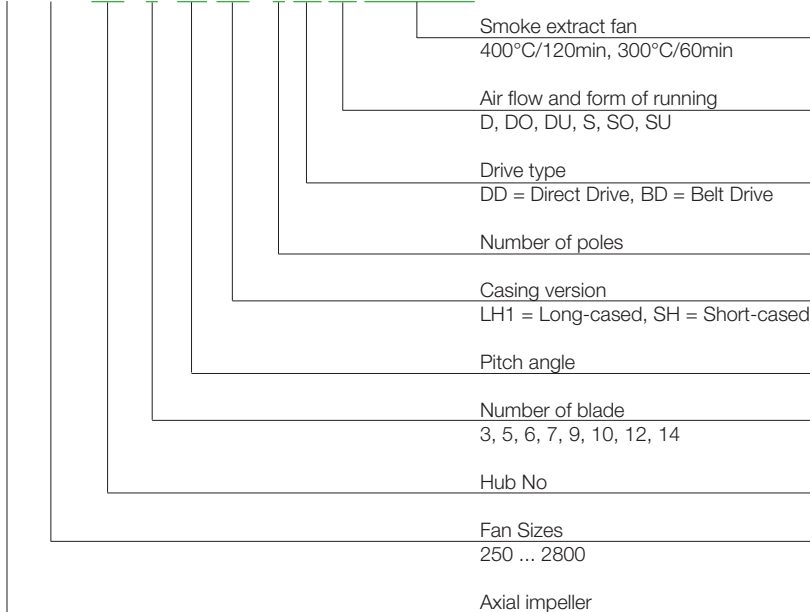

Dongguan Wolter Chemco Ventilation Ltd. certifies that the series AXV shown herein are licensed to bear the AMCA Seal. The ratings shown are based on tests and procedures performed in accordance with AMCA Publication 211 and AMCA Publication 311 and comply with the requirements of the AMCA Certified Ratings Program.

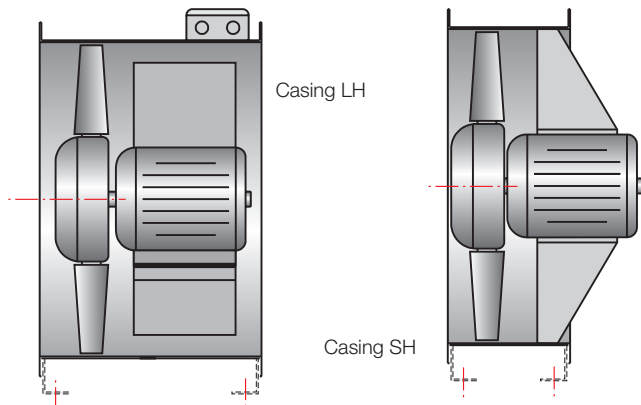

### Design features

#### Types and duty range

Wolter Axial flow fans can be used for various applications in ventilation and process air technology. Standard diameters range from 250 to 2800mm, with airflow rates of up to 290 m³/s at static pressure increases of up to 1600 Pa. Higher pressures can be achieved by using contra-rotating multi-stage fans.

Belt driven fans are designed for application that required motor to be isolated from the airstreams.

#### Smoke spill operation

The AXV range of axial fans is designed and tested to operate at standard temperatures as well as at elevated temperatures of 300°C for 60 (F300) and 120 minutes and 400°C for at least 120 minutes (F400), according to DIN EN ISO 12101, part 3. The following fan curves are valid for standard temperatures and 300°/60 (F300) and 120 minutes operation. To select a fan for 400°C/120 minutes operation, please contact our technical support.

#### Casing

Fan casings are of hot-dip galvanized finishing. Flanges are rolled, the pitch circles of holes are in accordance with DIN 24 154, R2.

- ▶ LH - Long-cased axial fan, with external terminal box
- ▶ SH - Short-cased axial fan

If motors require additional lubrication, tubes and grease-nipples are fitted to the outside of the fan casing. An inspection hole, closed by a rubber plug, allows technical personnel to view the direction of impeller rotation.

#### Impellers

AXV impellers, hubs and blades are made off pressure-cast aluminium alloy, the aerodynamic profile guarantees high efficiency and low noise levels. The blade pitch angle is adjustable during standstill. The variable number of blades the expands the performance range.

#### Motor

Wolter uses closed squirrel cage motors according to IEC 34, if required also in accordance with EPACKT. Standard motors are class F with IP 55 protection class. Multi speed versions with 2 or 3 speeds (Dahlander circuit or separate windings) are also available, as well as explosion-proof versions or specific industrial executions such as marine-type fans. The motor bearings have a L 10 life

#### Forms of running

Wolter AXV axial flow fans are available for all forms of running. The right chart shows all standard forms of running. Please indicate the required configuration when ordering. Without specific instructions, fans will be delivered in configuration S. Arrows outside the fan casing indicates the correct direction of rotation and airflow.

Form D, DU and DO are not licensed by AMCA International.

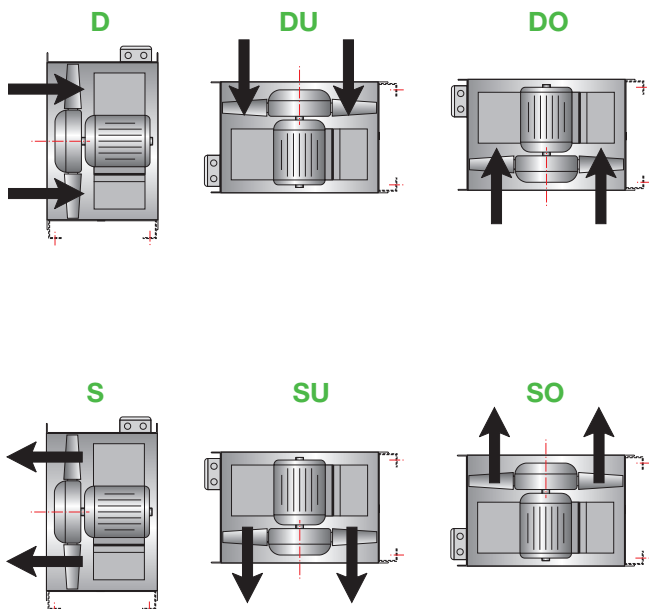



AXV DD



AXV BD



### Fan performance curves

The performance curves for these fan types have been established in mounting installation type A or D (according to AMCA 210, installation type A - free inlet free outlet for size 1400 and above, installation type D - ducted inlet and ducted outlet for for size 1250 and below) and represent the total pressure increase  $\Delta p_t$  as a function of the volume flow. The dynamic pressure  $p_d$  is related to the flange cross-sectional area at the of the fan.

### Sound levels

The ascertaining of the sound level follows the Reverberant Room Method in accordance to AMCA 300. The A-weighted sound power levels is shown on the performance curves.

### Belt driven design

Belt driven fan with single / dual motors can be mounted in various positions

to suit the actual site condition. Belt driven fans are used for applications to extract more heavily polluted air i.e. presence of corrosive or hazardous fumes, or dirt-laden, moist air or hot air from professional kitchens. Various mounting positions are illustrated.

### Ordering designations

When ordering, please provide the following information:

- › fan type code (see above), casing version and form of running
- › duty required at standard air temperature (air volume in m<sup>3</sup>/h at static pressure in Pa)
- › motor power rating in kW
- › electrical supply
- › required ancillary equipment

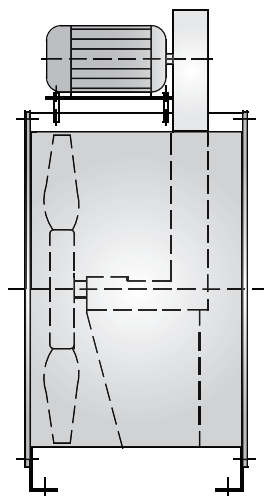

Motor Mounting at Zero Position

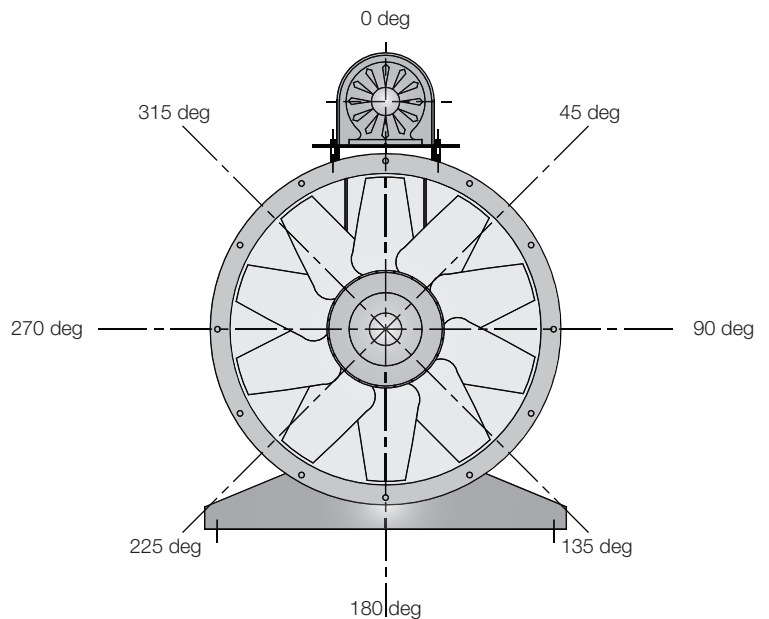

Motor Mounting Position - Specify in degree

AMCA 210 Figure 12  
ISO 5801 Figure 73b

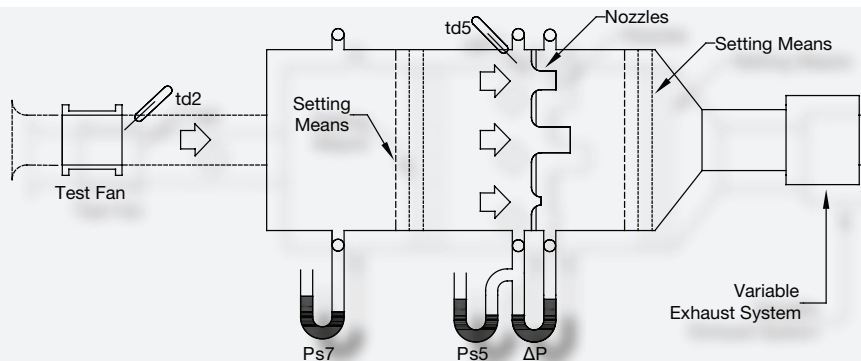

AMCA 210 Figure 15  
ISO 5801 Figure 75D

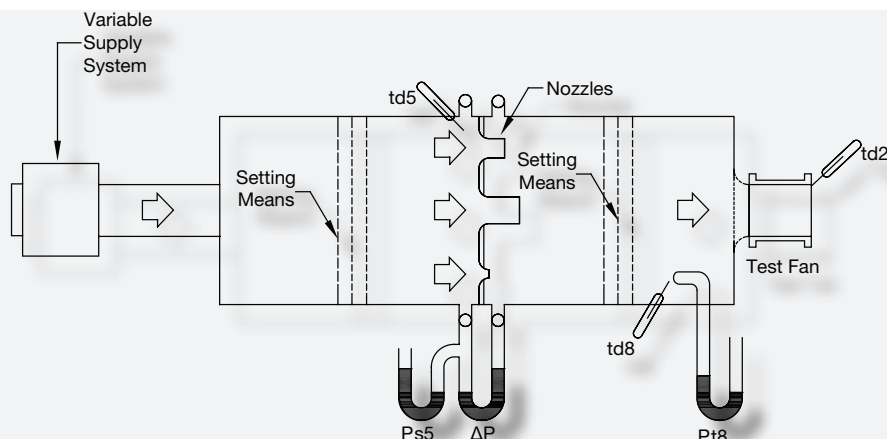

# Axial Flow Fans

## Technical Information

### Fan selection and installation

#### Fan selection

Please select fans according to the nearest performance curve above the required duty point. The middle range of each fan curve is the area of highest efficiency. Do not select fans at the upper end of the fan curve, as this might cause the fan to work in stall. In order to avoid motor overloading, please select motors according to the peak power of the respective performance curve. Please refer to the selection example on the following page.

#### Fan installation

When installing the fan, please consider the following instructions:

- ▶ Fans with free inlet and outlet should be installed with an unobstructed distance of at least 1,5 x fan diameter on suction and pressure sides. Fans should have a bellmouth on the inlet side in order to assure optimal incoming flow. A diffusor mounted on the pressure side will increase efficiency.
- ▶ When installing fans in a ducted system, adequate distance to other structural parts such as bends, filters and silencers should be provided for. A sharp bend radius of the duct near the suction or pressure side of the fan is to be avoided. Flexible connections are to be installed in a way that does not obstruct the outlet cross section of the fan (see following page).

### Selection example

#### Required duty point

- ▶ Volume flow : 5.000 m<sup>3</sup>/h
- ▶ Static pressure: 110 Pa

In order to calculate the total pressure, please add velocity pressure to static pressure (30 Pa dynamic pressure + 110 Pa static pressure = 140 Pa total pressure)

- ▶ Fan speed: 1.440 1/min (4-pole)

#### Using the fan curve

Having chosen a fan with adequate performance range for the required duty point, plot volume flow and pressure.

At the point of intersection, the following data can be read:

- ▶ Motor speed or number of poles 1.440 1/min - 4-pole
- ▶ Pitch angle: 18 degrees
- ▶ FEG Rating: FEG71 (see page 5)
- ▶ Inlet sound power level: 80 dB(A) if use of plastic duct  
77 dB(A) if use of unlined metal duct

### Calculation of motor power:

There are two possibilities to calculate the motor power:

- 1) Calculation of absorbed power by using the fan curve in duty point:  
0,338 kW

Motor power: 0,37 kW

- 2) Calculation according to peak absorbed power, see table below the fan curve: 0,366 kW

Motor power: 0,37 kW

The given peak absorbed power is the maximum shaft absorbed power over the whole pitch angle in.

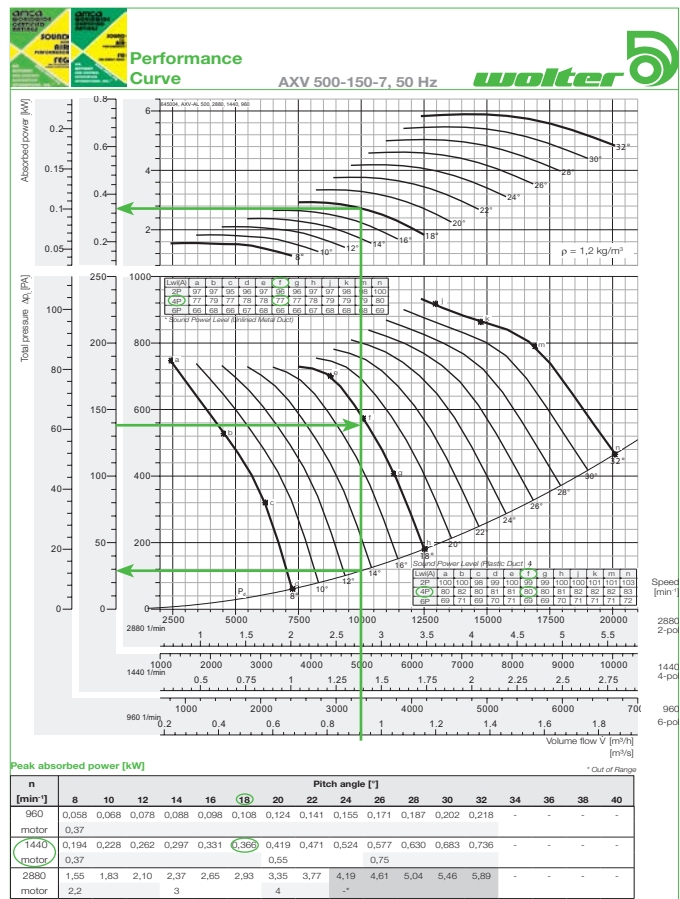
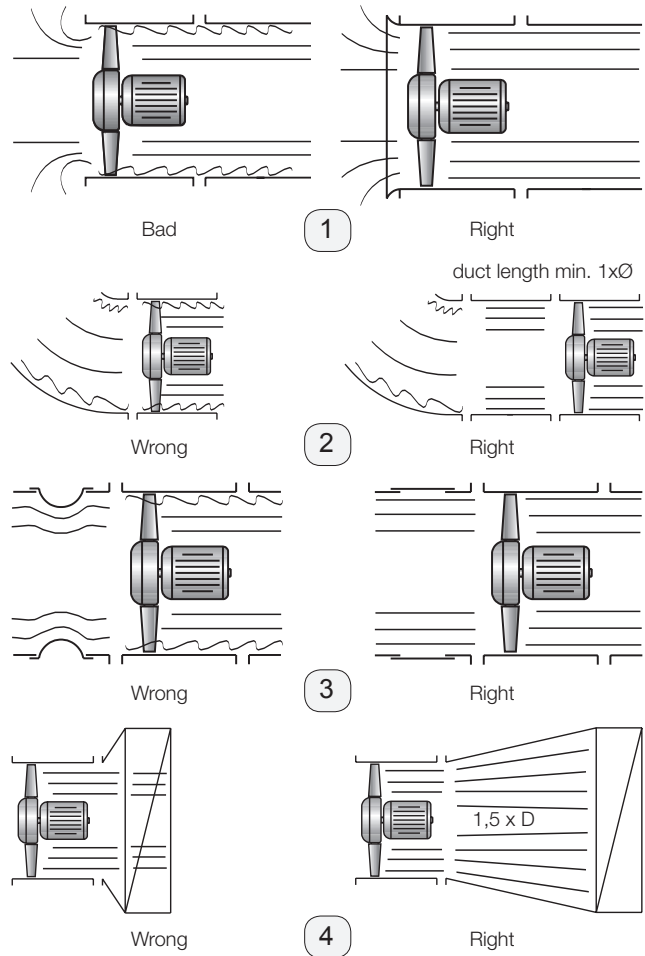

# AMCA - FEG rating

## Fan Efficiency Grade - AXV



Certified FEGs are determined in accordance with AMCA 205 Energy Efficiency Classification for fans. In conjunction with AMCA 211 Certified Ratings Program, Product Rating Manual for Fan Air Performance. This classification is based on total peak, or optimum, fan efficiency for a given fan speed, impeller diameter and test application category (test configuration). For the purpose of energy classification, the peak efficiency shall be determined at a speed that is lower than the fan's maximum design speed.

The AMCA Certified Ratings Seal applies to the Fan Efficiency Grade (FEG) for AXV series Axial Fan model AXV 250 to AXV 2800 as shown in the table below.

Fan Model No.	Fan Speed (rpm)	Fan Efficiency Grades	Fan Model No.	Fan Speed (rpm)	Fan Efficiency Grade
AXV 250-110-3	3000/1500/1000	FEG 67	AXV 630-150-5	1500/1000/750	FEG 75
AXV 250-110-6	3000/1500/1000	FEG 60	AXV 630-150-10	1500/1000/750	FEG 75
AXV 280-110-3	3000/1500/1000	FEG 75	AXV 630-200-9	2880/1440/960	FEG 63
AXV 280-110-6	3000/1500/1000	FEG 67	AXV 630-250-7	1500/1000/750	FEG 71
AXV 315-110-3	3000/1500/1000	FEG 71	AXV 630-250-14	1500/1000/750	FEG 63
AXV 315-110-6	3000/1500/1000	FEG 67	AXV 710-110-3	1500/1000/750	FEG 75
AXV 355-110-3	3000/1500/1000	FEG 75	AXV 710-110-6	1500/1000/750	FEG 75
AXV 355-110-6	3000/1500/1000	FEG 71	AXV 710-150-5	1500/1000/750	FEG 75
AXV 355-150-7	2880/1440/960	FEG 63	AXV 710-150-10	1500/1000/750	FEG 75
AXV 400-110-3	3000/1500/1000	FEG 75	AXV 710-250-7	1500/1000/750	FEG 71
AXV 400-110-6	3000/1500/1000	FEG 71	AXV 710-250-9	1440/960/720	FEG 67
AXV 400-150-5	3000/1500/1000	FEG 71	AXV 710-250-14	1500/1000/750	FEG 67
AXV 400-150-7	2880/1440/960	FEG 67	AXV 800-150-5	1500/1000/750	FEG 75
AXV 400-150-10	3000/1500/1000	FEG 63	AXV 800-150-10	1500/1000/750	FEG 75
AXV 450-110-3	3000/1500/1000	FEG 71	AXV 800-250-7	1500/1000/750	FEG 75
AXV 450-110-6	3000/1500/1000	FEG 80	AXV 800-250-9	1440/960/720	FEG 71
AXV 450-150-5	3000/1500/1000	FEG 71	AXV 800-250-14	1500/1000/750	FEG 71
AXV 450-150-7	2880/1440/960	FEG 63	AXV 900-250-7	1500/1000/750	FEG 71
AXV 450-150-10	3000/1500/1000	FEG 63	AXV 900-250-14	1500/1000/750	FEG 67
AXV 500-110-3	3000/1500/1000	FEG 75	AXV 900-300-10	1440/960/720	FEG 63
AXV 500-110-6	3000/1500/1000	FEG 75	AXV 1000-250-7	1500/1000/750	FEG 71
AXV 500-150-5	3000/1500/1000	FEG 71	AXV 1000-250-14	1500/1000/750	FEG 67
AXV 500-150-7	2880/1440/960	FEG 71	AXV 1000-300-10	1440/960/720	FEG 71
AXV 500-150-10	3000/1500/1000	FEG 71	AXV 1120-300-5	1440/960/720	FEG 71
AXV 500-250-7	3000/1500/1000	FEG 56	AXV 1250-370-6	1440/960/720	FEG 71
AXV 560-110-3	3000/1500/1000	FEG 71	AXV 1400-420-6	960/720/576	FEG 75
AXV 560-110-6	3000/1500/1000	FEG 75	AXV 1600-420-6	960/720/576	FEG 67
AXV 560-150-5	3000/1500/1000	FEG 75	AXV 1800-540-6	960/720/576	FEG 75
AXV 560-150-10	3000/1500/1000	FEG 71	AXV 2000-600-6	960/720/576	FEG 75
AXV 560-200-9	2880/1440/960	FEG 67	AXV 2200-660-6	720/576/480	FEG 75
AXV 560-250-7	3000/1500/1000	FEG 67	AXV 2400-720-6	720/576/480	FEG 75
AXV 560-250-14	3000/1500/1000	FEG 56	AXV 2500-750-6	720/576/480	FEG 75
AXV 630-110-3	1500/1000/750	FEG 75	AXV 2600-780-6	720/576/480	FEG 75
AXV 630-110-6	1500/1000/750	FEG 75	AXV 2800-840-6	720/576/480	FEG 75



# Performance Curve

AXV 250-110-3, 50 Hz

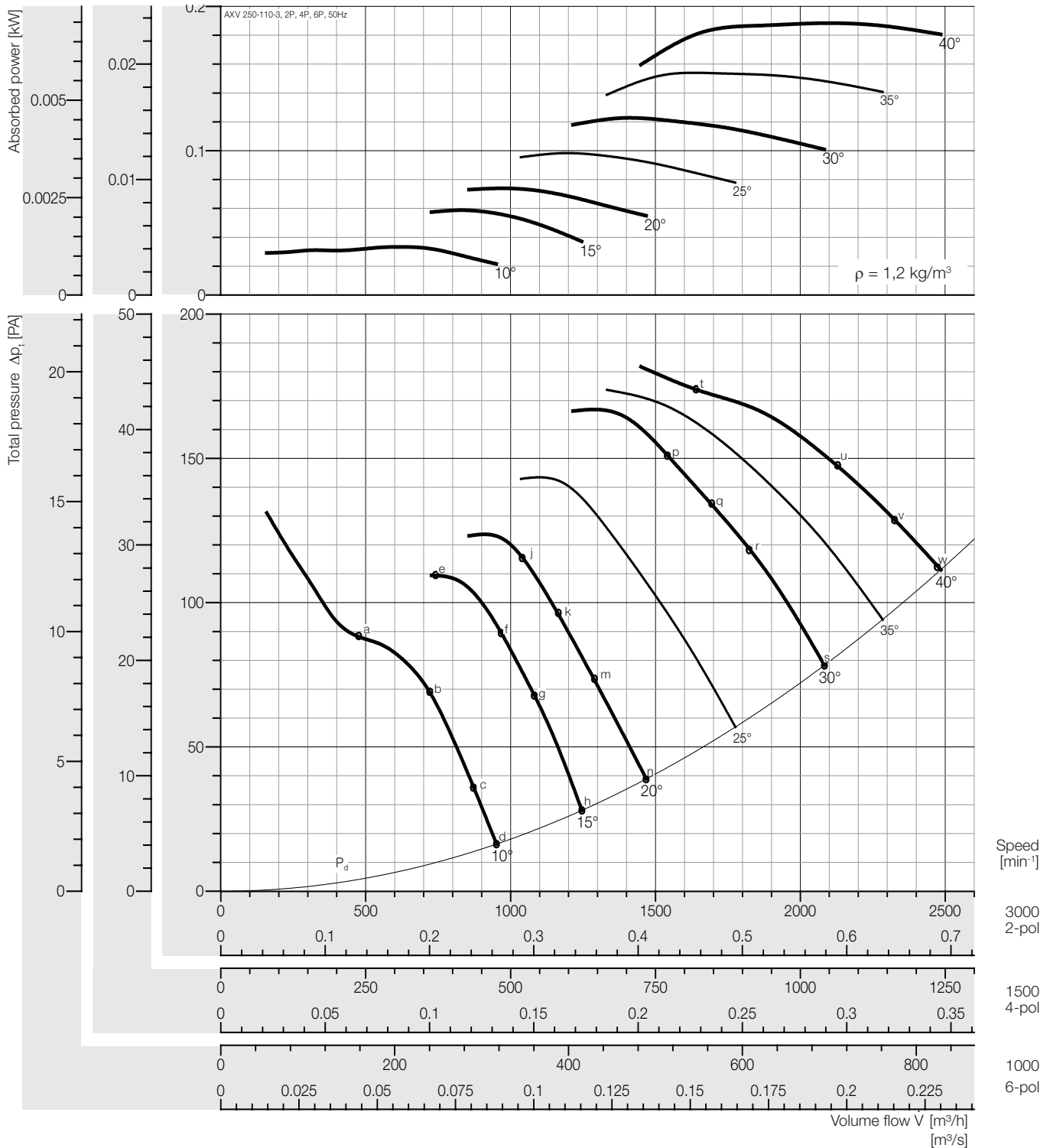

### Peak absorbed power [kW]

n [min <sup>-1</sup> ]	Pitch angle [°]						
	10	15	20	25	30	35	40
1000	0,001	0,002	0,003	0,004	0,005	0,006	0,007
Motor	0,06						
1500	0,004	0,007	0,009	0,012	0,015	0,019	0,024
Motor	0,09						
3000	0,033	0,059	0,074	0,098	0,123	0,154	0,188
Motor	0,12						

### Sound power level, Lwi(A) [dB(A)]

Lwi(A)	a	b	c	d	e	f	g	h	j	k	m	n	p	q	r	s	t	u	v	w
2P	86	81	82	83	88	83	83	85	80	81	82	83	84	85	86	86	90	91	92	88
4P	66	62	62	64	69	62	63	65	61	61	62	63	64	65	66	66	71	71	72	68
6P	54	50	51	52	57	51	51	54	49	50	50	52	51	53	53	54	60	60	60	56

Plastic Duct

Lwi(A)	a	b	c	d	e	f	g	h	j	k	m	n	p	q	r	s	t	u	v	w
2P	84	79	80	81	86	81	81	83	78	79	80	81	82	83	84	84	88	89	90	86
4P	64	60	60	64	67	60	61	63	59	59	60	61	62	63	64	64	69	69	70	66
6P	52	48	49	50	55	49	49	52	47	48	48	50	49	51	51	52	58	58	58	54

\* Unlined Metal Duct

The A-weighted sound ratings shown have been calculated per AMCA International Standard 301. Values shown are for inlet LwiA sound power levels for installation Type D: ducted inlet, ducted outlet. Ratings include the effects of duct end correction.

\* Sound power level with unlined metal duct were obtained from the test in the reverberant room. Data are not licensed by AMCA.

Fan test laboratory AMCA 210 Test Chamber. Performance certified is for installation type D - Ducted inlet, Ducted outlet. Performance ratings do not include the effects of appurtenances (accessories-belt cover, pulley & belt).

Dimensions + Accessories Page 191 - 194;

Sound power frequency spectrum L<sub>w</sub> Page 196 - 200.



# Performance Curve

AXV 250-110-6, 50 Hz

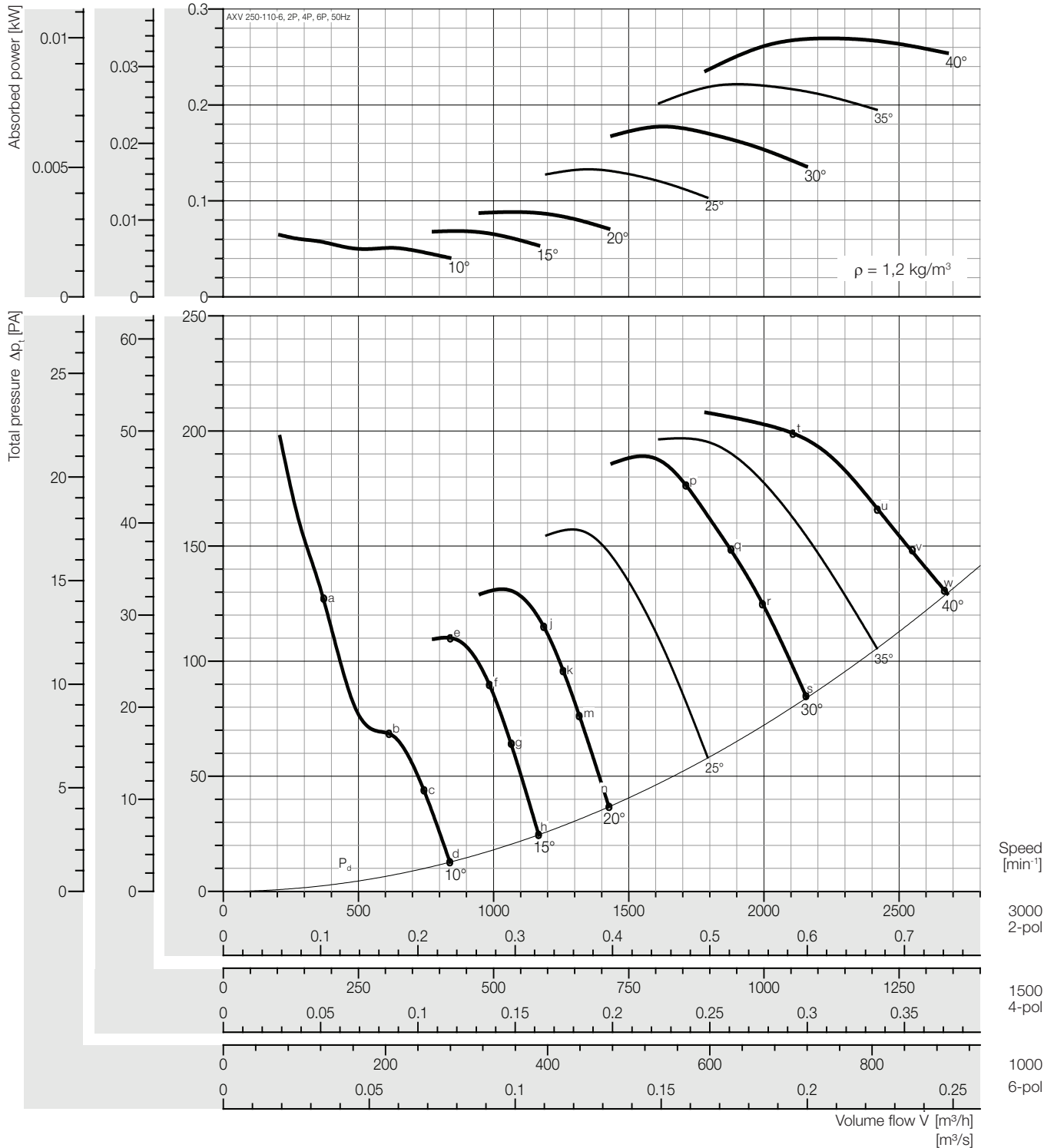

## Peak absorbed power [kW]

n [min <sup>-1</sup> ]	Pitch angle [°]						
	10	15	20	25	30	35	40
1000	0,003	0,003	0,003	0,005	0,007	0,008	0,010
Motor	0,06						
1500	0,009	0,009	0,011	0,017	0,022	0,028	0,034
Motor	0,09						
3000	0,070	0,069	0,088	0,133	0,177	0,222	0,269
Motor	0,12		0,18		0,25		

## Sound power level, Lwi(A) [dB(A)]

Lwi(A)	a	b	c	d	e	f	g	h	j	k	m	n	p	q	r	s	t	u	v	w
2P	87	84	81	81	89	85	85	86	86	86	87	87	84	86	85	87	89	90	91	92
4P	66	65	62	62	69	65	66	66	66	67	67	67	65	66	66	67	70	71	72	72
6P	56	54	50	51	58	54	54	55	55	55	55	56	53	54	55	56	59	59	60	61

Plastic Duct

Lwi(A)	a	b	c	d	e	f	g	h	j	k	m	n	p	q	r	s	t	u	v	w
2P	85	82	79	79	87	83	83	84	84	84	85	85	82	84	83	85	87	88	89	90
4P	64	63	60	60	67	63	64	64	64	65	65	65	63	64	64	65	68	69	70	70
6P	54	52	48	49	56	52	52	53	53	53	53	54	51	52	53	54	57	57	58	59

\* Unlined Metal Duct

Fan test laboratory AMCA 210 Test Chamber. Performance certified is for installation type D - Ducted inlet, Ducted outlet. Performance ratings do not include the effects of appurtenances (accessories-belt cover, pulley & belt).

Dimensions + Accessories Page 191 - 194;  
Sound power frequency spectrum L<sub>wnd</sub> Page 196 - 200.

The A-weighted sound ratings shown have been calculated per AMCA International Standard 301. Values shown are for inlet LwiA sound power levels for installation Type D: ducted inlet, ducted outlet. Ratings include the effects of duct end correction.

\* Sound power level with unlined metal duct were obtained from the test in the reverberant room. Data are not licensed by AMCA.





# Performance Curve

AXV 280-110-3, 50 Hz

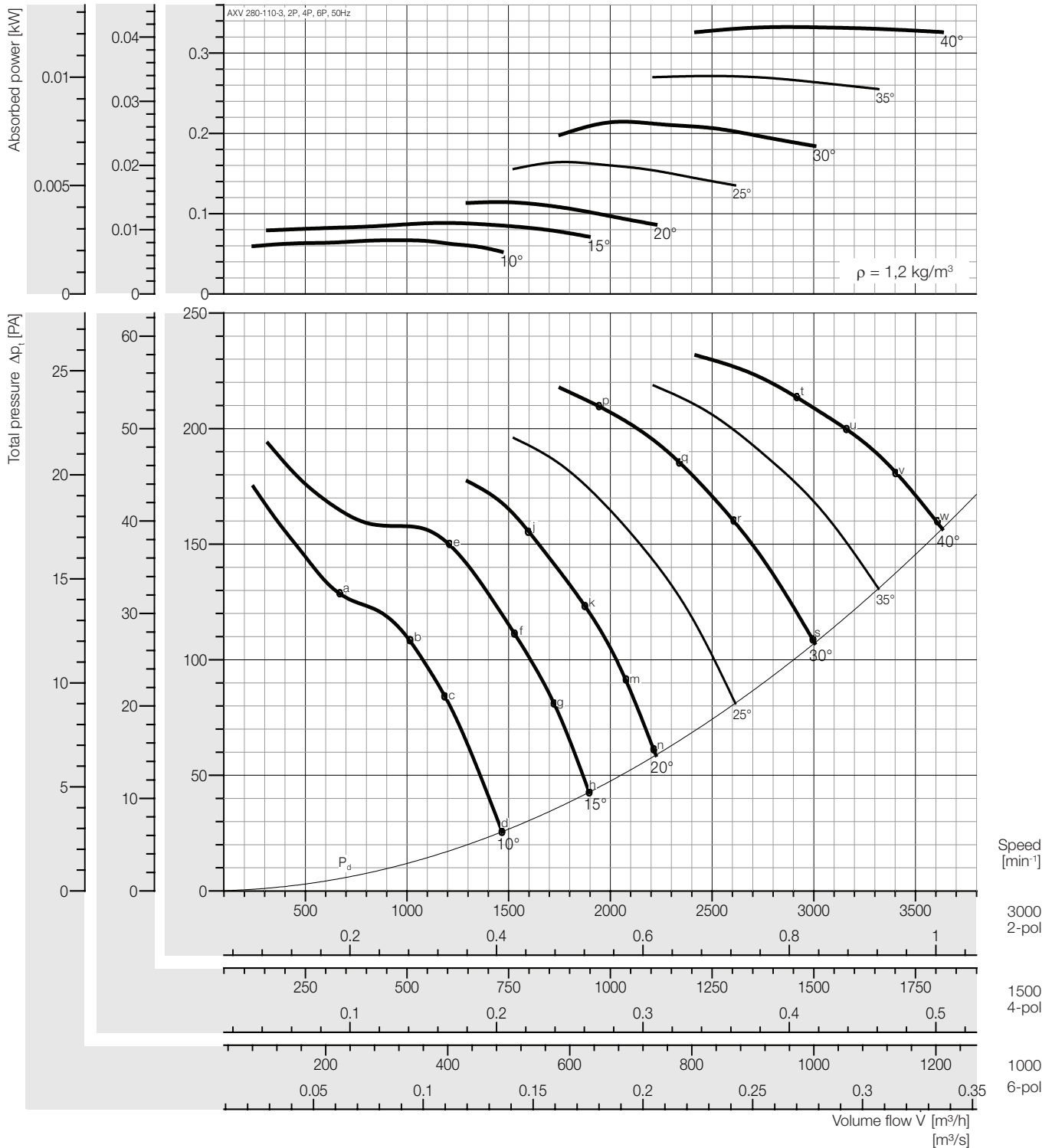

### Peak absorbed power [kW]

n [min <sup>-1</sup> ]	Pitch angle [°]						
	10	15	20	25	30	35	40
1000	0,002	0,003	0,004	0,006	0,008	0,010	0,012
Motor	0,06						
1500	0,008	0,011	0,014	0,021	0,027	0,034	0,042
Motor	0,09						
3000	0,067	0,088	0,114	0,164	0,214	0,271	0,332
Motor	0,12		0,18		0,25	0,37	

### Sound power level, Lwi(A) [dB(A)]

Lwi(A)	a	b	c	d	e	f	g	h	j	k	m	n	p	q	r	s	t	u	v	w
2P	86	85	84	86	84	85	86	87	84	86	86	87	85	87	87	89	88	89	89	91
4P	66	66	64	65	63	63	64	65	63	64	64	66	65	66	67	68	68	68	69	70
6P	54	55	53	54	51	52	52	54	52	53	53	54	53	55	55	57	57	57	58	59

Plastic Duct

Lwi(A)	a	b	c	d	e	f	g	h	j	k	m	n	p	q	r	s	t	u	v	w
2P	84	83	82	84	82	83	84	85	82	84	84	85	83	84	84	87	86	87	87	89
4P	64	64	62	63	61	61	62	63	61	62	62	64	63	64	65	66	66	66	67	68
6P	52	53	51	52	49	50	50	52	50	51	51	52	51	53	53	55	55	55	56	57

\* Unlined Metal Duct

Fan test laboratory AMCA 210 Test Chamber. Performance certified is for installation type D - Ducted inlet, Ducted outlet. Performance ratings do not include the effects of appurtenances (accessories-belt cover, pulley & belt).

Dimensions + Accessories Page 191 - 194;  
Sound power frequency spectrum L<sub>w</sub> Page 196 - 200.

The A-weighted sound ratings shown have been calculated per AMCA International Standard 301. Values shown are for inlet LwiA sound power levels for installation Type D: ducted inlet, ducted outlet. Ratings include the effects of duct end correction.

\* Sound power level with unlined metal duct were obtained from the test in the reverberant room. Data are not licensed by AMCA.



# Performance Curve

AXV 280-110-6, 50 Hz

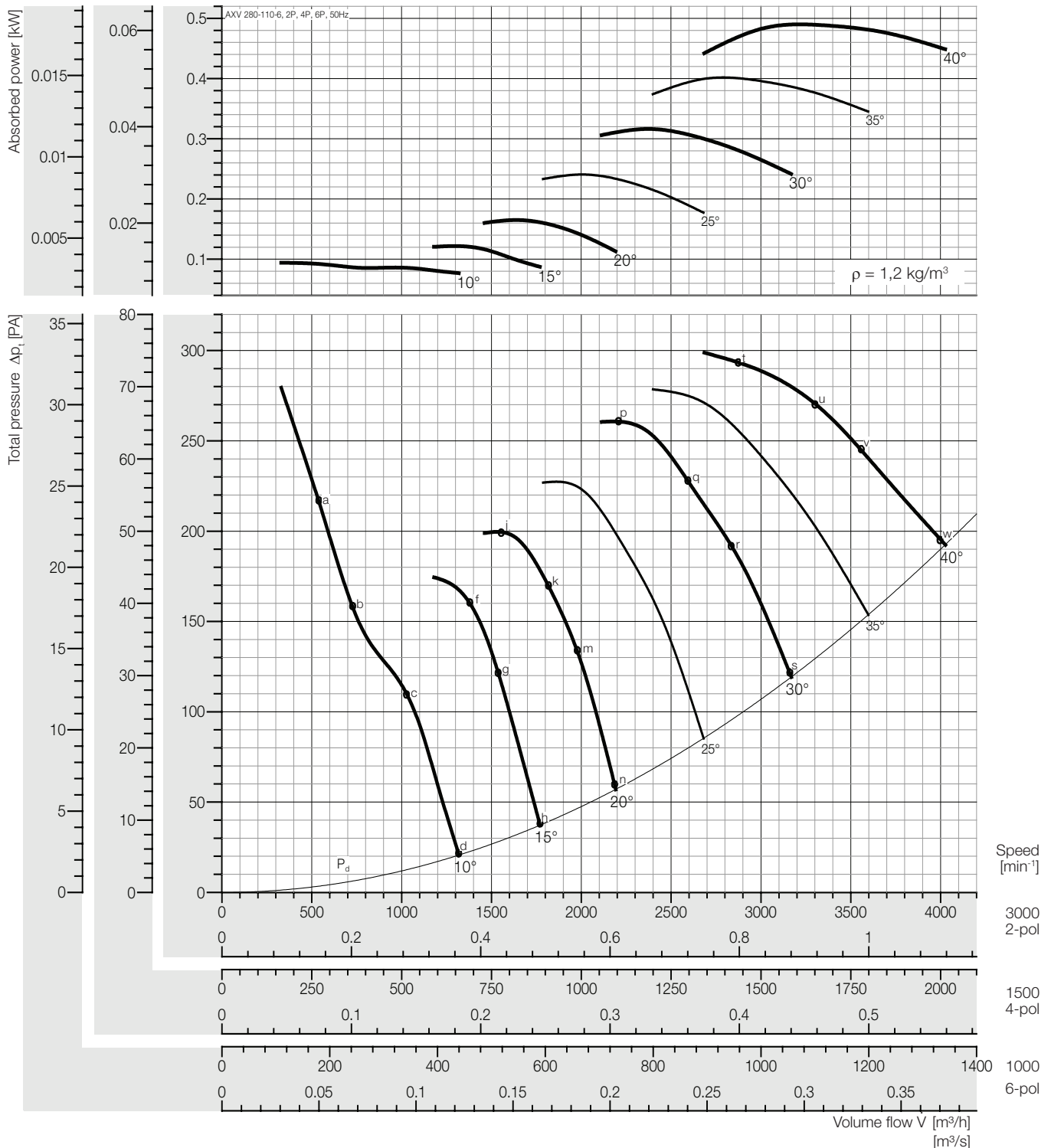

## Peak absorbed power [kW]

n [min <sup>-1</sup> ]	Pitch angle [°]						
	10	15	20	25	30	35	40
1000	0,004	0,005	0,006	0,009	0,012	0,015	0,018
Motor	0,06						
1500	0,012	0,015	0,021	0,030	0,040	0,050	0,061
Motor	0,09						
3000	0,095	0,122	0,165	0,241	0,316	0,402	0,490
Motor	0,12	0,18	0,25	0,37	0,55		

## Sound power level, Lwi(A) [dB(A)]

Lwi(A)	a	b	c	d	e	f	g	h	j	k	m	n	p	q	r	s	t	u	v	w
2P	89	88	85	86	-	88	89	90	87	88	88	90	92	88	89	91	91	92	92	93
4P	68	67	66	66	-	68	68	70	67	67	68	69	75	68	69	70	70	70	70	71
6P	58	57	56	56	-	58	58	59	57	57	58	59	66	58	59	60	60	60	60	60

Plastic Duct

Lwi(A)	a	b	c	d	e	f	g	h	j	k	m	n	p	q	r	s	t	u	v	w
2P	87	86	83	84	-	86	87	88	85	86	86	88	90	86	87	89	89	90	90	91
4P	66	65	64	64	-	66	66	68	65	65	66	67	73	66	67	68	68	68	68	69
6P	56	55	54	54	-	56	56	57	55	55	56	57	64	56	57	58	58	58	58	58

\* Unlined Metal Duct

Fan test laboratory AMCA 210 Test Chamber. Performance certified is for installation type D - Ducted inlet, Ducted outlet. Performance ratings do not include the effects of appurtenances (accessories-belt cover, pulley & belt).

Dimensions + Accessories Page 191 - 194;  
Sound power frequency spectrum L<sub>w</sub> Page 196 - 200.

The A-weighted sound ratings shown have been calculated per AMCA International Standard 301. Values shown are for inlet Lwi(A) sound power levels for installation Type D: ducted inlet, ducted outlet. Ratings include the effects of duct end correction.

\* Sound power level with unlined metal duct were obtained from the test in the reverberant room. Data are not licensed by AMCA.



# Performance Curve

AXV 315-110-3, 50 Hz

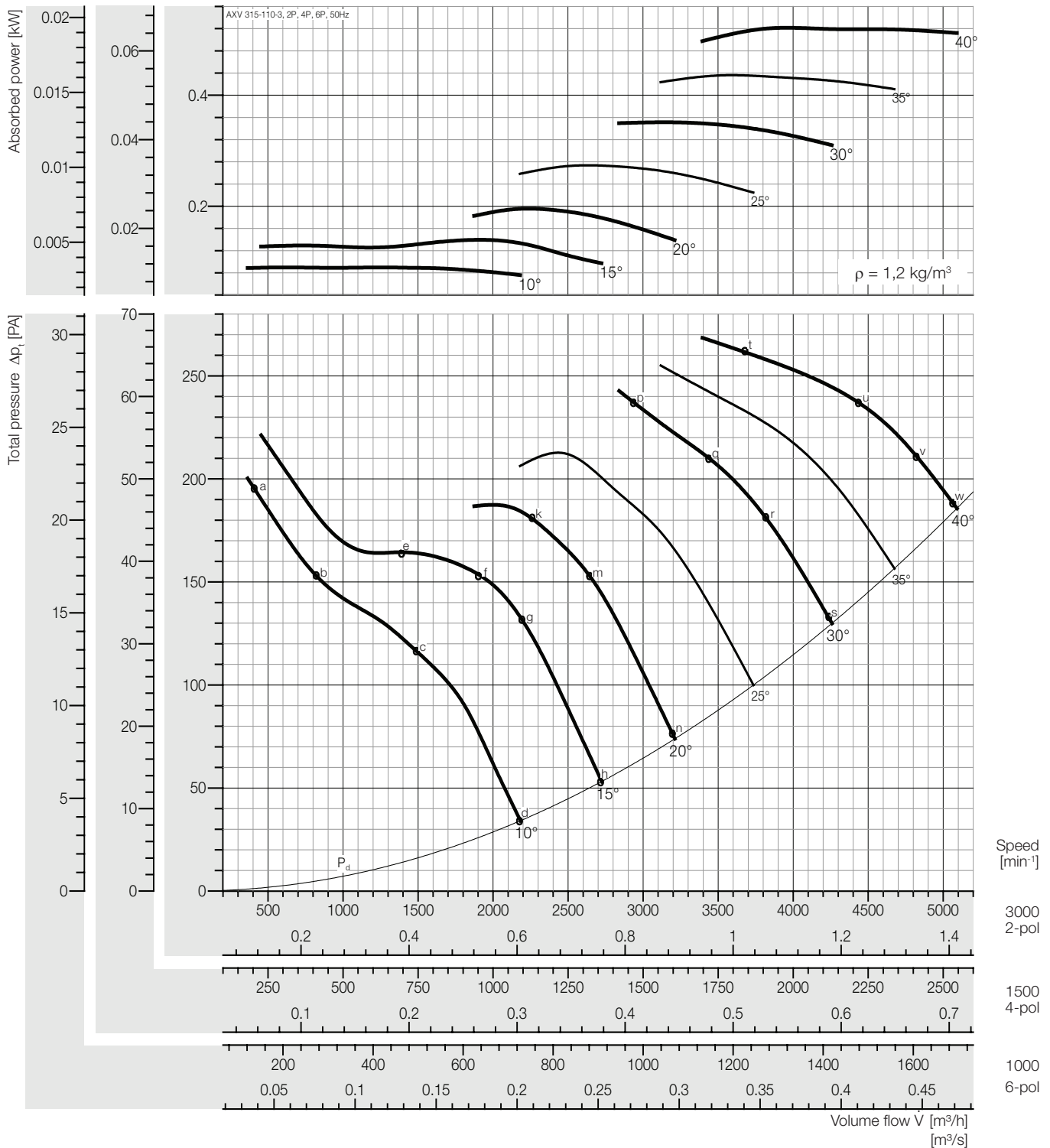

## Peak absorbed power [kW]

n [min <sup>-1</sup> ]	Pitch angle [°]						
	10	15	20	25	30	35	40
1000	0,003	0,005	0,007	0,010	0,013	0,016	0,019
Motor	0,06						
1500	0,011	0,017	0,024	0,034	0,044	0,054	0,065
Motor	0,09						
3000	0,090	0,139	0,195	0,273	0,351	0,436	0,522
Motor	0,12	0,18	0,25	0,37	0,55		

## Sound power level, Lwi(A) [dB(A)]

Lwi(A)	a	b	c	d	e	f	g	h	j	k	m	n	p	q	r	s	t	u	v	w
2P	86	87	87	85	90	85	84	86	-	84	84	89	87	88	90	91	90	91	91	91
4P	67	67	69	65	71	67	65	67	-	65	65	69	68	68	70	71	71	71	72	72
6P	55	55	58	54	59	56	54	55	-	55	54	57	57	57	58	59	60	60	60	61

Plastic Duct

Lwi(A)	a	b	c	d	e	f	g	h	j	k	m	n	p	q	r	s	t	u	v	w
2P	84	85	85	83	88	83	82	84	-	82	82	87	85	86	88	89	88	89	89	89
4P	65	65	67	63	69	65	63	65	-	63	63	67	66	66	68	69	69	69	70	70
6P	53	53	56	52	57	54	52	53	-	53	52	55	55	55	56	57	58	58	58	59

\* Unlined Metal Duct

The A-weighted sound ratings shown have been calculated per AMCA International Standard 301. Values shown are for inlet LwiA sound power levels for installation Type D: ducted inlet, ducted outlet. Ratings include the effects of duct end correction.

\* Sound power level with unlined metal duct were obtained from the test in the reverberant room. Data are not licensed by AMCA.

Fan test laboratory AMCA 210 Test Chamber. Performance certified is for installation type D - Ducted inlet, Ducted outlet. Performance ratings do not include the effects of appurtenances (accessories-belt cover, pulley & belt).

Dimensions + Accessories Page 191 - 194;

Sound power frequency spectrum L<sub>w</sub> Page 196 - 200.



# Performance Curve

AXV 315-110-6, 50 Hz

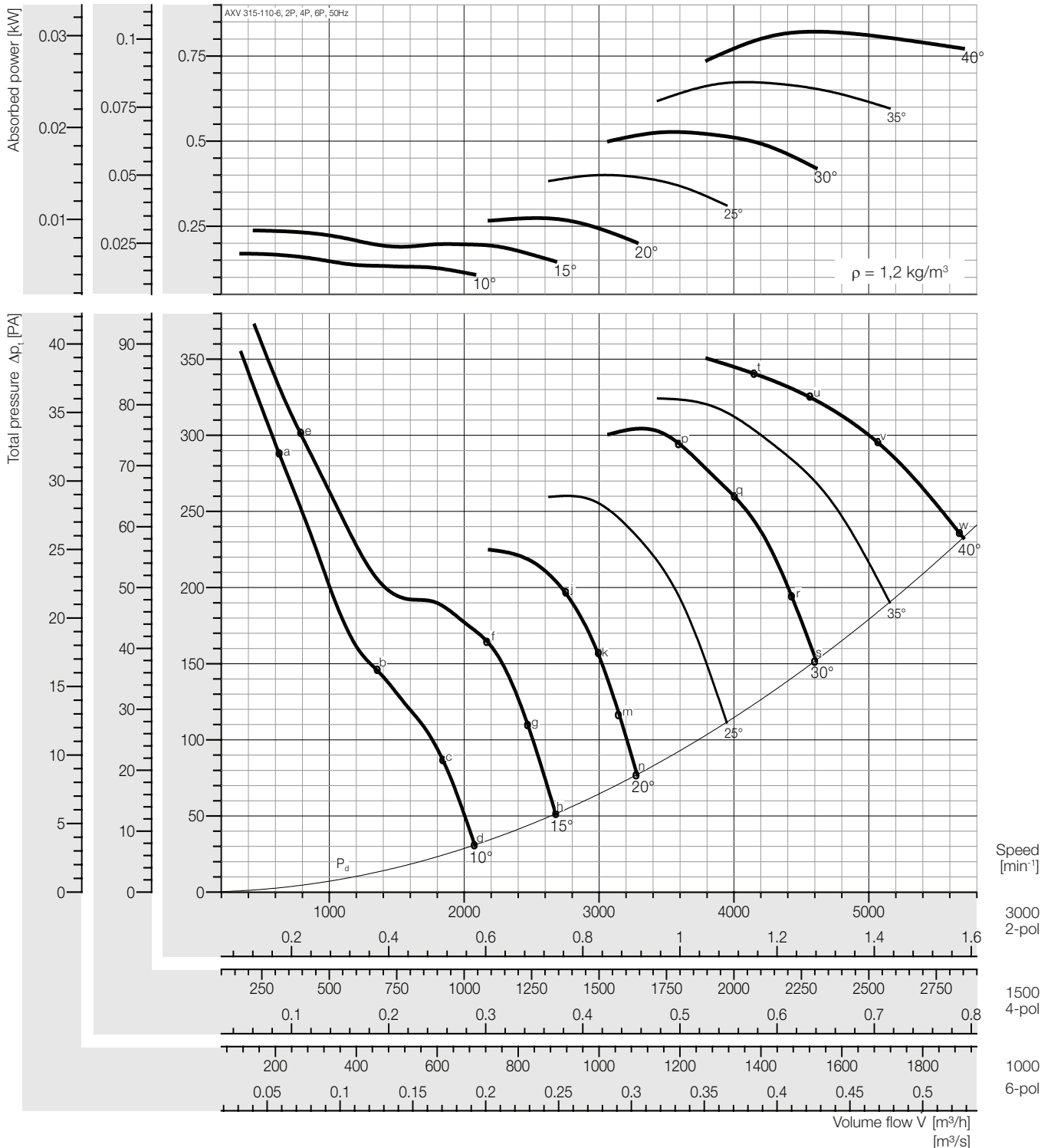

### Peak absorbed power [kW]

n [min <sup>-1</sup> ]	Pitch angle [°]						
	10	15	20	25	30	35	40
1000	0,006	0,009	0,010	0,015	0,020	0,025	0,030
Motor	0,06						
1500	0,021	0,030	0,034	0,050	0,066	0,084	0,103
Motor	0,09						
3000	0,170	0,238	0,274	0,400	0,527	0,673	0,821
Motor	0,18	0,25	0,37	0,55	0,75	1,1	

### Sound power level, Lwi(A) [dB(A)]

Lwi(A)	a	b	c	d	e	f	g	h	j	k	m	n	p	q	r	s	t	u	v	w
2P	90	90	86	87	94	88	89	89	89	91	92	91	90	92	91	89	92	92	94	94
4P	70	72	67	68	73	69	69	70	70	71	72	72	71	72	72	71	73	73	74	75
6P	60	61	57	57	63	58	58	59	59	61	61	60	60	61	60	60	62	62	63	64

Plastic Duct

Lwi(A)	a	b	c	d	e	f	g	h	j	k	m	n	p	q	r	s	t	u	v	w
2P	88	88	84	85	92	86	87	87	87	89	90	89	88	90	89	87	90	90	92	92
4P	68	70	65	66	71	67	67	68	68	69	70	70	69	70	70	69	71	71	72	73
6P	58	59	55	55	61	56	56	57	57	59	59	58	58	59	58	58	60	60	61	62

\* Unlined Metal Duct

Fan test laboratory AMCA 210 Test Chamber. Performance certified is for installation type D - Ducted inlet, Ducted outlet. Performance ratings do not include the effects of appurtenances (accessories-belt cover, pulley & belt).

Dimensions + Accessories Page 191 - 194;  
Sound power frequency spectrum L<sub>w</sub> Page 196 - 200.

The A-weighted sound ratings shown have been calculated per AMCA International Standard 301. Values shown are for inlet Lwi(A) sound power levels for installation Type D: ducted inlet, ducted outlet. Ratings include the effects of duct end correction.

\* Sound power level with unlined metal duct were obtained from the test in the reverberant room. Data are not licensed by AMCA.



# Performance Curve

AXV 355-110-3, 50 Hz

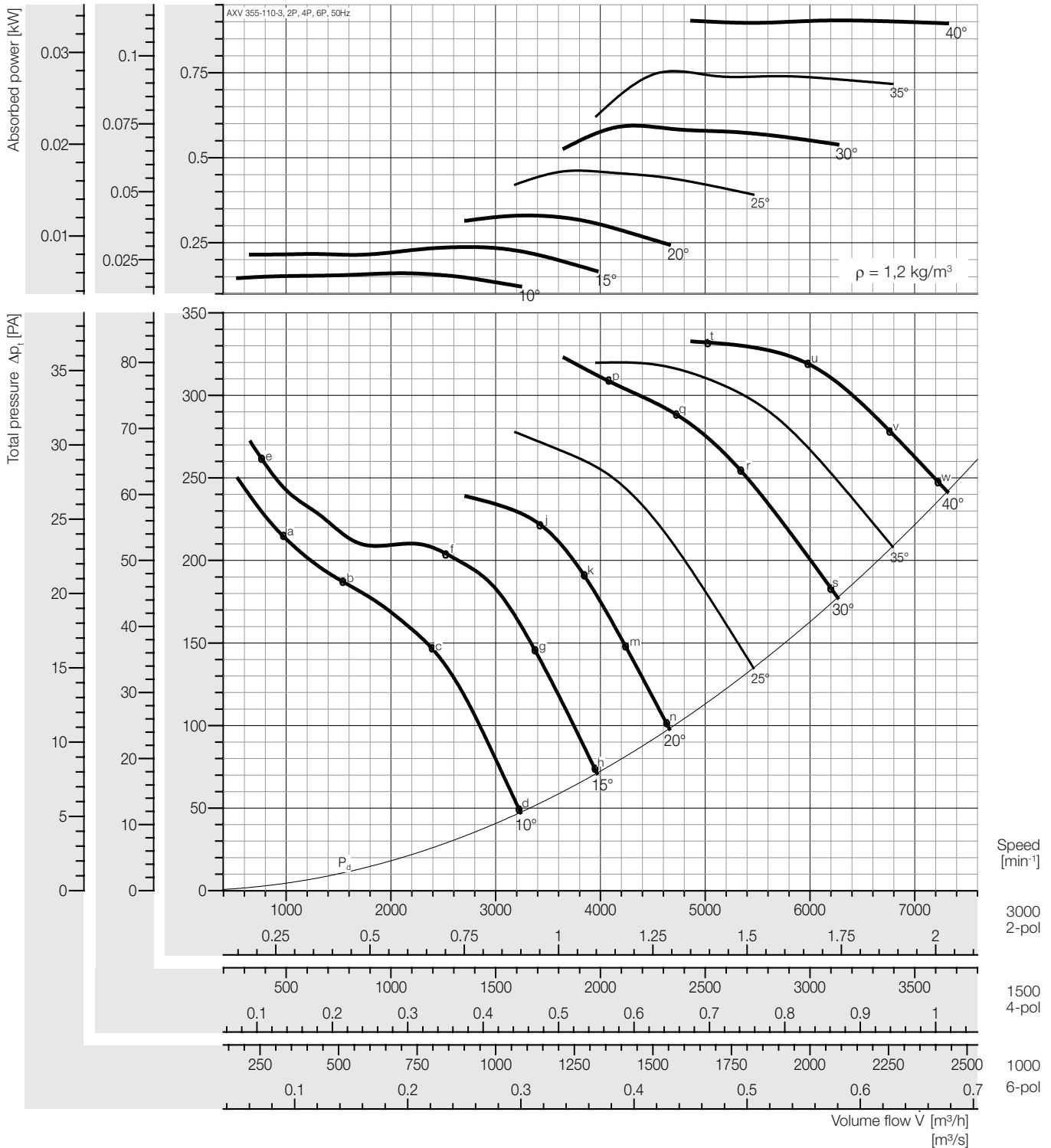

## Peak absorbed power [kW]

n [min <sup>-1</sup> ]	Pitch angle [°]						
	10	15	20	25	30	35	40
1000	0,006	0,009	0,012	0,017	0,022	0,028	0,033
Motor	0,09						
1500	0,020	0,030	0,041	0,058	0,074	0,094	0,113
Motor	0,12						
3000	0,160	0,237	0,330	0,461	0,593	0,752	0,904
Motor	0,18	0,25	0,37	0,55	0,75	1,1	

## Sound power level, Lwi(A) [dB(A)]

Lwi(A)	a	b	c	d	e	f	g	h	j	k	m	n	p	q	r	s	t	u	v	w
2P	91	92	89	87	91	91	88	89	89	89	91	92	92	92	93	95	91	92	93	93
4P	71	73	70	68	72	72	68	69	69	69	70	71	73	73	74	74	73	73	73	73
6P	59	61	59	57	60	61	56	58	57	57	58	59	62	62	63	62	62	62	62	62

Plastic Duct

Lwi(A)	a	b	c	d	e	f	g	h	j	k	m	n	p	q	r	s	t	u	v	w
2P	89	90	87	85	89	89	86	87	87	87	89	90	90	90	91	93	89	90	91	91
4P	69	71	68	66	70	70	66	67	67	67	68	69	71	71	72	72	71	71	71	71
6P	57	59	57	55	58	59	54	56	55	55	56	57	60	60	61	60	60	60	60	60

\* Unlined Metal Duct

The A-weighted sound ratings shown have been calculated per AMCA International Standard 301. Values shown are for inlet LwiA sound power levels for installation Type D: ducted inlet, ducted outlet. Ratings include the effects of duct end correction.

\* Sound power level with unlined metal duct were obtained from the test in the reverberant room. Data are not licensed by AMCA.

Fan test laboratory AMCA 210 Test Chamber. Performance certified is for installation type D - Ducted inlet, Ducted outlet. Performance ratings do not include the effects of appurtenances (accessories-belt cover, pulley & belt).

Dimensions + Accessories Page 191 - 194;

Sound power frequency spectrum L<sub>w</sub> Page 196 - 200.



# Performance Curve

AXV 355-110-6, 50 Hz

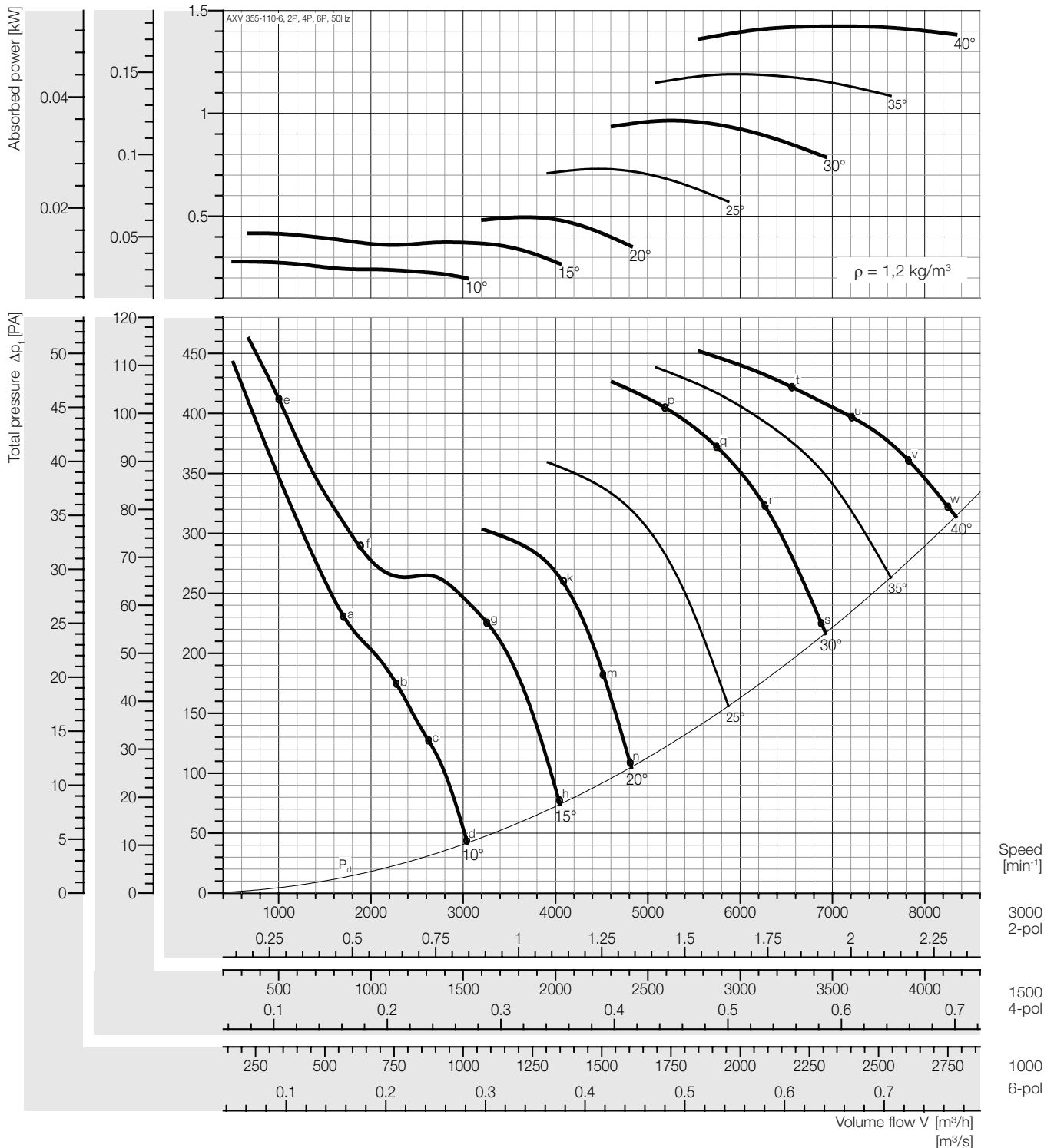

## Peak absorbed power [kW]

n [min <sup>-1</sup> ]	Pitch angle [°]						
	10	15	20	25	30	35	40
1000	0,010	0,015	0,018	0,027	0,036	0,044	0,053
Motor	0,09						
1500	0,035	0,052	0,062	0,091	0,120	0,149	0,178
Motor	0,12						
3000	0,280	0,417	0,495	0,729	0,963	1,191	1,424
Motor	0,37	0,55	0,75	1,1	1,5		

## Sound power level, Lwi(A) [dB(A)]

Lwi(A)	a	b	c	d	e	f	g	h	j	k	m	n	p	q	r	s	t	u	v	w
2P	94	94	92	92	98	100	96	94	100	94	95	96	92	93	95	95	94	95	96	97
4P	75	76	73	73	78	80	77	74	79	74	74	76	73	73	74	75	75	76	77	78
6P	64	65	63	62	67	69	66	63	69	64	64	65	62	63	64	64	64	65	66	67

Plastic Duct

Lwi(A)	a	b	c	d	e	f	g	h	j	k	m	n	p	q	r	s	t	u	v	w
2P	92	92	90	90	96	98	94	92	98	92	93	94	90	91	93	93	92	93	94	95
4P	73	74	71	71	76	78	75	72	77	72	72	74	71	71	72	73	73	74	75	76
6P	62	63	61	60	65	67	64	61	67	62	62	63	60	61	62	62	62	63	64	65

\* Unlined Metal Duct

The A-weighted sound ratings shown have been calculated per AMCA International Standard 301. Values shown are for inlet Lwi(A) sound power levels for installation Type D: ducted inlet, ducted outlet. Ratings include the effects of duct end correction.

\* Sound power level with unlined metal duct were obtained from the test in the reverberant room. Data are not licensed by AMCA.

Fan test laboratory AMCA 210 Test Chamber. Performance certified is for installation type D - Ducted inlet, Ducted outlet. Performance ratings do not include the effects of appurtenances (accessories-belt cover, pulley & belt).

Dimensions + Accessories Page 191 - 194;  
Sound power frequency spectrum L<sub>w</sub> Page 196 - 200.



# Performance Curve

AXV 355-150-7, 50 Hz

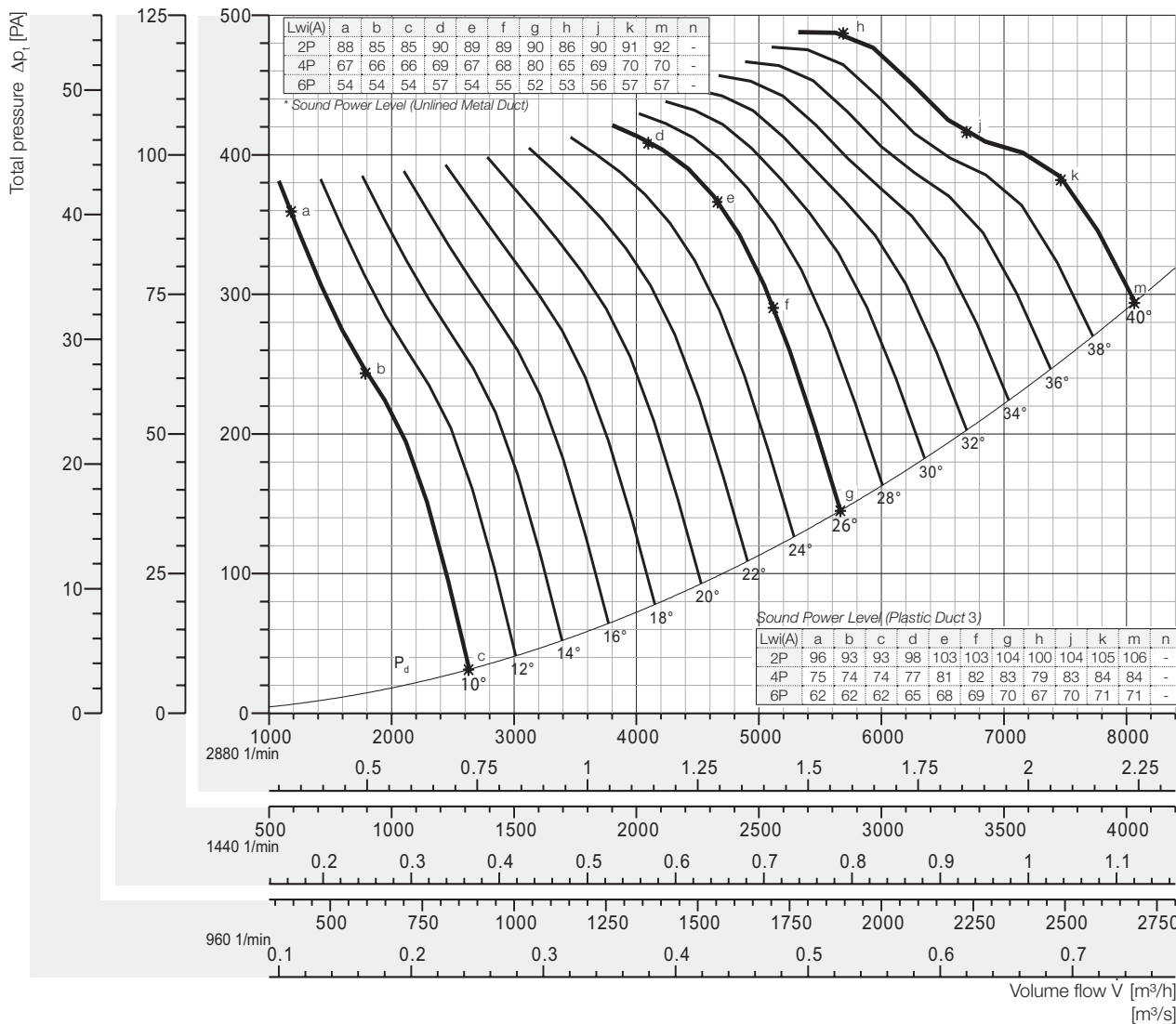
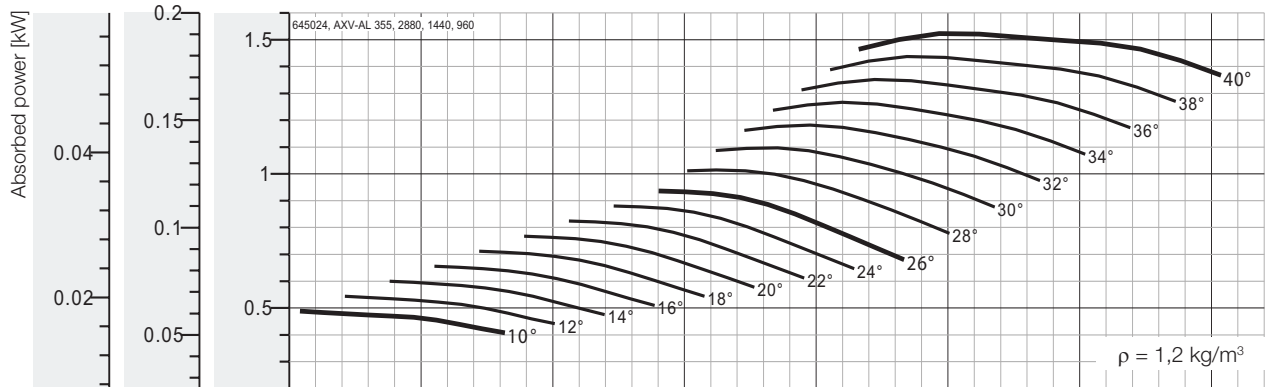

Speed [min<sup>-1</sup>]  
2880 2-pol  
1440 4-pol  
960 6-pol

## Peak absorbed power [kW]

n [min <sup>-1</sup> ]	Pitch angle [°]																
	8	10	12	14	16	18	20	22	24	26	28	30	32	34	36	38	40
960 motor	-	0,018	0,020	0,022	0,024	0,026	0,028	0,031	0,033	0,035	0,038	0,041	0,044	0,047	0,050	0,053	0,056
		0,37															
1440 motor	-	0,061	0,068	0,075	0,082	0,089	0,096	0,103	0,110	0,117	0,127	0,137	0,148	0,158	0,169	0,180	0,190
		0,37															
2880 motor	-	0,488	0,544	0,600	0,656	0,712	0,768	0,824	0,880	0,936	1,01	1,10	1,18	1,267	1,352	1,44	1,52
		0,55	0,75				1,1						1,5				2,2

Fan test laboratory AMCA 210 Test Chamber. Performance certified is for installation type D - Ducted inlet, Ducted outlet. Performance ratings do not include the effects of appurtenances (accessories-belt cover, pulley & belt).

Dimensions + Accessories Page 191 - 194;  
Sound power frequency spectrum L<sub>max</sub> Page 196 - 200.

The A-weighted sound ratings shown have been calculated per AMCA International Standard 301. Values shown are for inlet Lw<sub>i</sub> sound power levels for installation Type D: ducted inlet, ducted outlet. Ratings include the effects of duct end correction.

\* Sound power level with unlined metal duct were obtained from the test in the reverberant room. Data are not licensed by AMCA.



# Performance Curve

AXV 400-110-3, 50 Hz

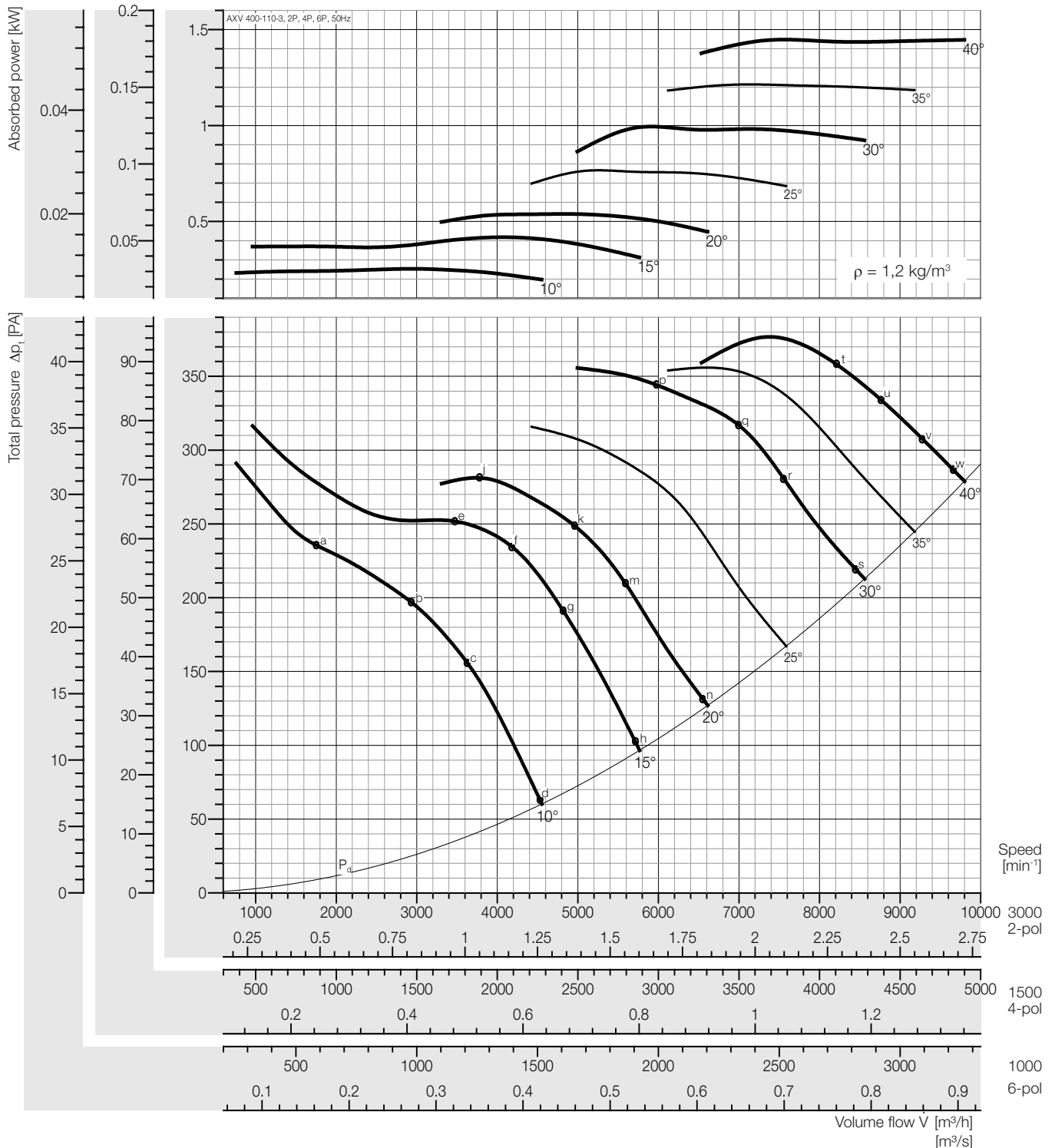

## Peak absorbed power [kW]

n [min <sup>-1</sup> ]	Pitch angle [°]						
	10	15	20	25	30	35	40
1000	0,009	0,015	0,020	0,028	0,037	0,045	0,054
Motor	0,12						
1500	0,032	0,052	0,067	0,096	0,124	0,152	0,181
Motor	0,12						0,18
3000	0,253	0,418	0,539	0,765	0,992	1,214	1,448
Motor	0,37	0,55	1,1		1,5		

## Sound power level, Lwi(A) [dB(A)]

Lwi(A)	a	b	c	d	e	f	g	h	j	k	m	n	p	q	r	s	t	u	v	w
2P	92	95	91	92	96	92	93	95	97	96	96	96	94	96	97	98	97	98	99	99
4P	73	77	73	71	78	73	72	73	77	74	74	74	74	75	75	76	77	77	78	78
6P	61	65	62	61	66	63	61	62	66	63	63	63	64	64	64	65	66	67	67	68

Plastic Duct

Lwi(A)	a	b	c	d	e	f	g	h	j	k	m	n	p	q	r	s	t	u	v	w
2P	90	93	89	90	94	90	91	93	95	94	94	94	92	94	95	96	95	96	97	97
4P	71	75	71	69	76	71	70	71	75	72	72	72	72	73	73	74	75	75	76	76
6P	59	63	60	59	64	61	59	60	64	61	61	61	62	62	62	63	64	65	65	66

\* Unlined Metal Duct

Fan test laboratory AMCA 210 Test Chamber. Performance certified is for installation type D - Ducted inlet, Ducted outlet. Performance ratings do not include the effects of appurtenances (accessories-belt cover, pulley & belt).

Dimensions + Accessories Page 191 - 194;  
Sound power frequency spectrum L<sub>w</sub> Page 196 - 200.

The A-weighted sound ratings shown have been calculated per AMCA International Standard 301. Values shown are for inlet LwiA sound power levels for installation Type D: ducted inlet, ducted outlet. Ratings include the effects of duct end correction.

\* Sound power level with unlined metal duct were obtained from the test in the reverberant room. Data are not licensed by AMCA.





# Performance Curve

AXV 400-110-6, 50 Hz

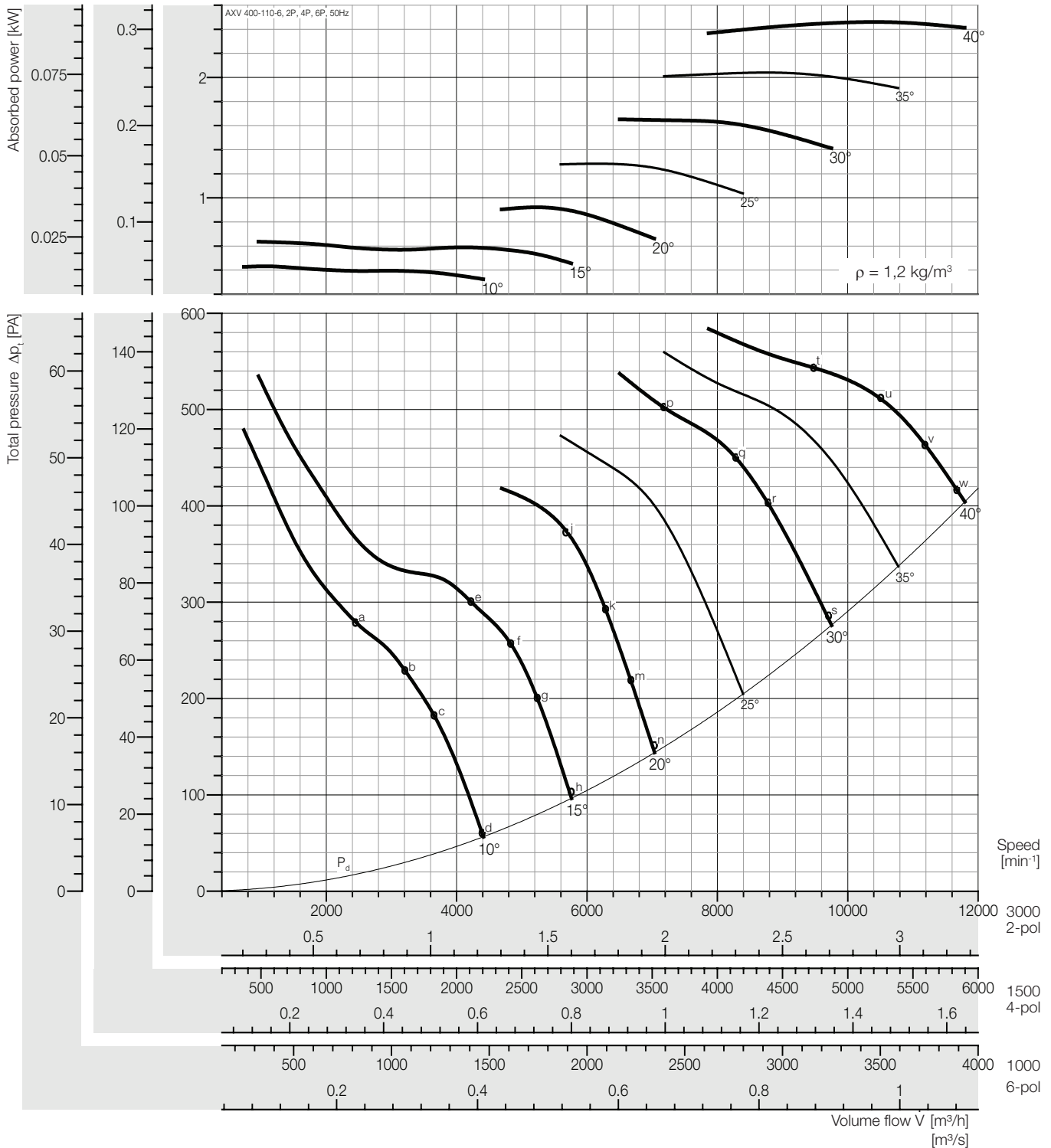

### Peak absorbed power [kW]

n [min <sup>-1</sup> ]	Pitch angle [°]						
	10	15	20	25	30	35	40
1000	0,016	0,024	0,034	0,048	0,061	0,076	0,091
Motor	0,12						
1500	0,054	0,080	0,115	0,160	0,207	0,255	0,308
Motor	0,12						
3000	0,432	0,636	0,922	1,283	1,652	2,040	2,460
Motor	0,55	0,75	1,1	1,5	2,2	3,0	

### Sound power level, Lwi(A) [dB(A)]

Lwi(A)	a	b	c	d	e	f	g	h	j	k	m	n	p	q	r	s	t	u	v	w
2P	95	97	95	97	98	96	96	96	94	95	96	98	96	97	97	98	96	96	97	98
4P	77	79	78	77	80	76	77	77	75	75	76	77	76	77	77	79	78	78	79	80
6P	66	69	67	67	69	66	67	66	65	65	66	67	66	67	67	68	68	67	68	69

Plastic Duct

Lwi(A)	a	b	c	d	e	f	g	h	j	k	m	n	p	q	r	s	t	u	v	w
2P	93	95	93	95	96	94	94	94	92	93	94	96	94	95	95	96	94	94	95	96
4P	75	77	76	75	78	74	75	75	73	73	74	75	74	75	75	77	76	76	77	78
6P	64	67	65	65	67	64	65	64	63	63	64	65	64	65	65	66	66	65	66	67

\* Unlined Metal Duct

The A-weighted sound ratings shown have been calculated per AMCA International Standard 301. Values shown are for inlet LwiA sound power levels for installation Type D: ducted inlet, ducted outlet. Ratings include the effects of duct end correction.

\* Sound power level with unlined metal duct were obtained from the test in the reverberant room. Data are not licensed by AMCA.

Fan test laboratory AMCA 210 Test Chamber. Performance certified is for installation type D - Ducted inlet, Ducted outlet. Performance ratings do not include the effects of appurtenances (accessories-belt cover, pulley & belt).

Dimensions + Accessories Page 191 - 194;

Sound power frequency spectrum L<sub>w</sub> Page 196 - 200.



# Performance Curve

AXV 400-150-5, 50 Hz

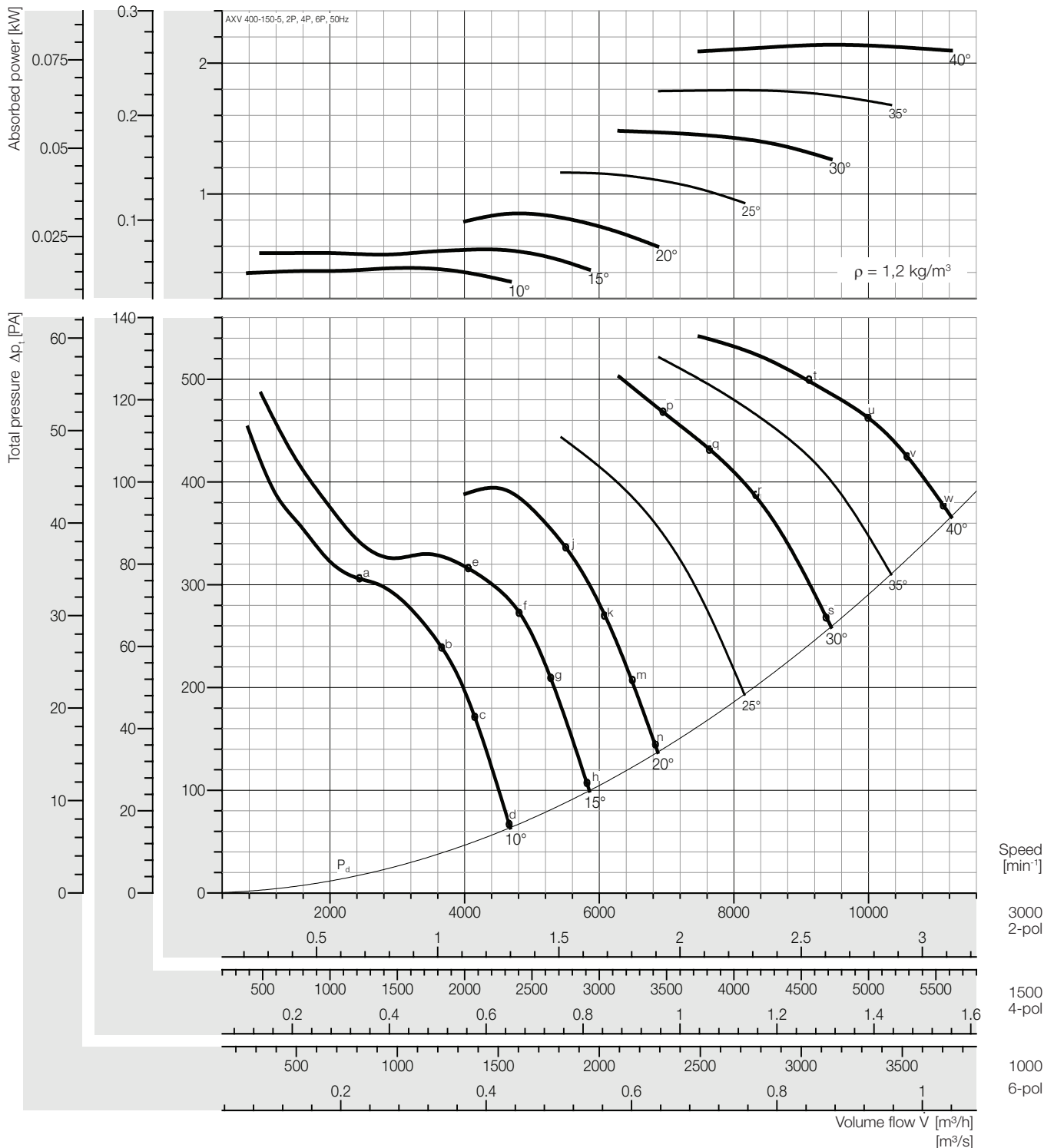

### Peak absorbed power [kW]

n [min <sup>-1</sup> ]	Pitch angle [°]						
	10	15	20	25	30	35	40
1000	0,016	0,021	0,031	0,043	0,055	0,066	0,079
Motor	0,12						
1500	0,054	0,072	0,106	0,145	0,185	0,224	0,268
Motor	0,12		0,18		0,25	0,37	
3000	0,433	0,576	0,849	1,164	1,482	1,793	2,140
Motor	0,55	0,75	1,1	1,5	2,2		

### Sound power level, Lwi(A) [dB(A)]

Lwi(A)	a	b	c	d	e	f	g	h	j	k	m	n	p	q	r	s	t	u	v	w
2P	97	92	91	92	96	92	93	94	92	92	93	94	96	96	99	99	100	101	101	
4P	78	75	73	75	79	74	75	76	73	74	74	75	77	77	77	79	80	81	81	82
6P	67	64	63	65	68	64	64	65	63	63	63	65	65	65	67	68	69	70	70	

Plastic Duct

Lwi(A)	a	b	c	d	e	f	g	h	j	k	m	n	p	q	r	s	t	u	v	w
2P	95	90	89	90	94	90	91	92	90	90	91	92	94	94	94	97	97	98	99	99
4P	76	73	71	73	77	72	73	74	71	72	72	73	75	75	75	77	78	79	79	80
6P	65	62	61	63	66	62	62	63	61	61	61	63	63	63	63	65	66	67	68	68

\* Unlined Metal Duct

Fan test laboratory AMCA 210 Test Chamber. Performance certified is for installation type D - Ducted inlet, Ducted outlet. Performance ratings do not include the effects of appurtenances (accessories-belt cover, pulley & belt).

Dimensions + Accessories Page 191 - 194;  
Sound power frequency spectrum L<sub>w</sub> Page 196 - 200.

The A-weighted sound ratings shown have been calculated per AMCA International Standard 301. Values shown are for inlet Lwi(A) sound power levels for installation Type D: ducted inlet, ducted outlet. Ratings include the effects of duct end correction.

\* Sound power level with unlined metal duct were obtained from the test in the reverberant room. Data are not licensed by AMCA.



# Performance Curve

AXV 400-150-7, 50 Hz

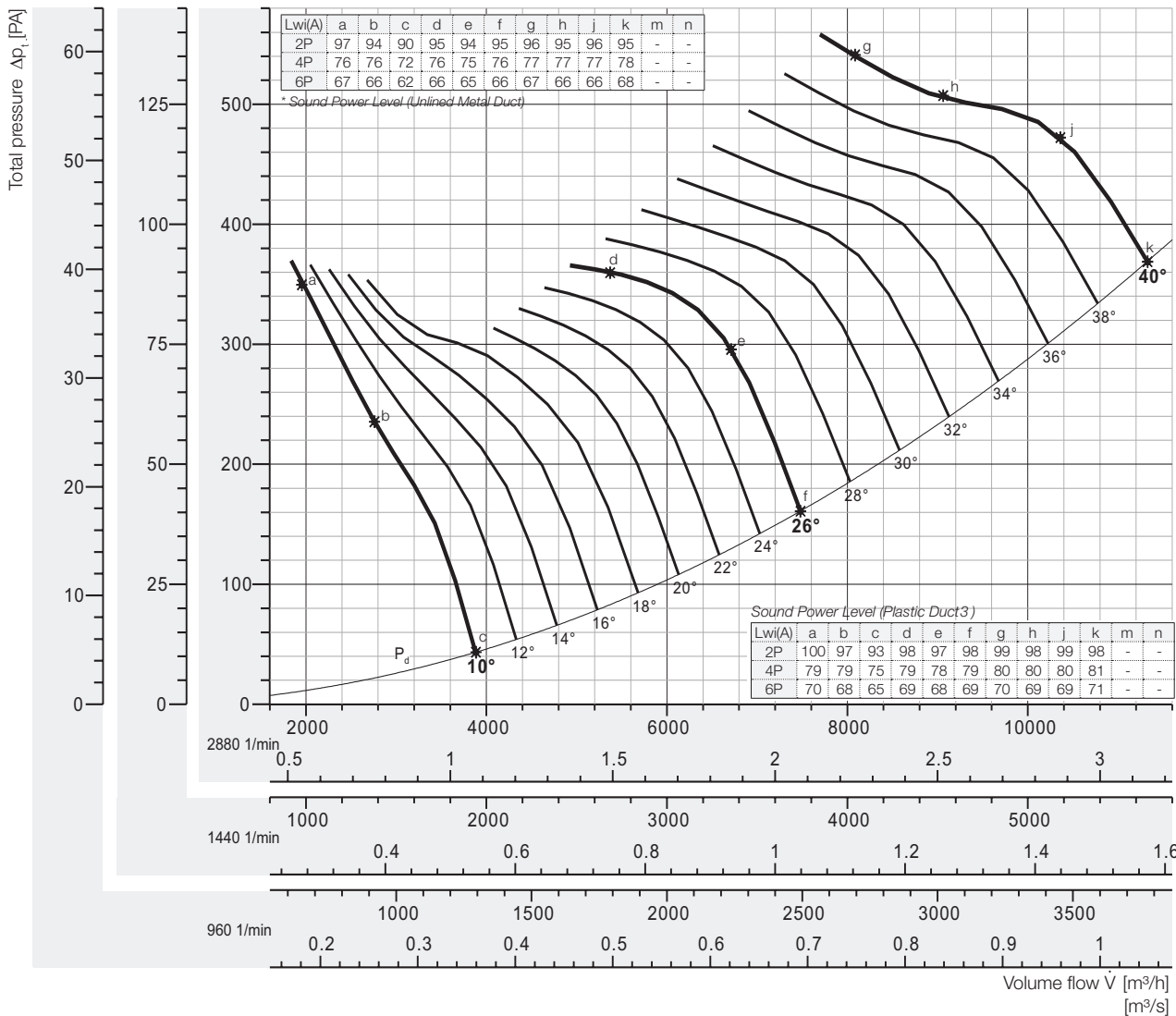
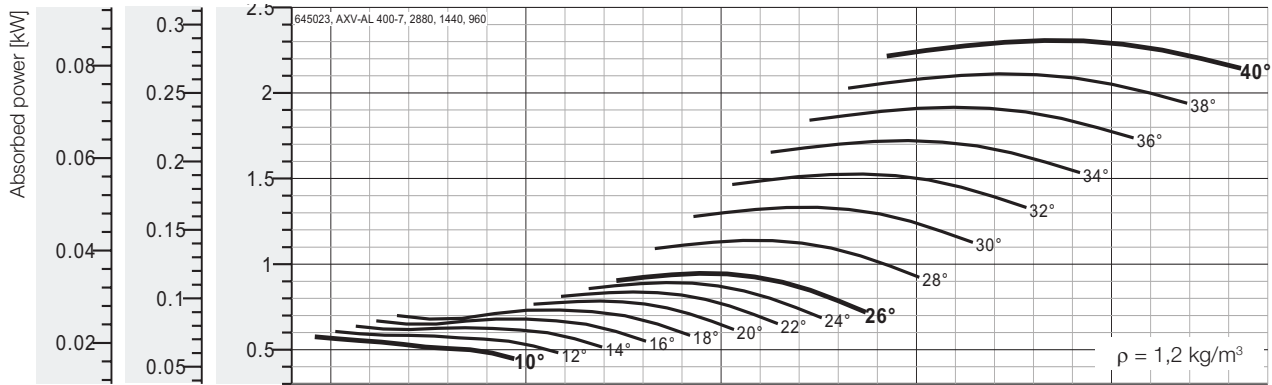

## Peak absorbed power [kW]

n [min <sup>-1</sup> ]	Pitch angle [°]																
	8	10	12	14	16	18	20	22	24	26	28	30	32	34	36	38	40
960 motor	-	0,021	0,022	0,024	0,025	0,027	0,029	0,031	0,033	0,035	0,042	0,049	0,057	0,064	0,071	0,078	0,085
		0,37															
1440 motor	-	0,072	0,076	0,080	0,085	0,092	0,098	0,105	0,111	0,118	0,142	0,166	0,191	0,215	0,240	0,264	0,288
		0,37															
2880 motor	-	0,576	0,607	0,638	0,679	0,733	0,784	0,838	0,892	0,946	1,14	1,33	1,53	1,72	1,92	2,11	2,31
		0,75					1,1				1,5		2,2				3

Fan test laboratory AMCA 210 Test Chamber. Performance certified is for installation type D - Ducted inlet, Ducted outlet. Performance ratings do not include the effects of appurtenances (accessories-belt cover, pulley & belt).

Dimensions + Accessories Page 191 ~ 194;  
Sound power frequency spectrum L<sub>max</sub> Page 196 ~ 200.

The A-weighted sound ratings shown have been calculated per AMCA International Standard 301. Values shown are for inlet Lw(A) sound power levels for installation Type D: ducted inlet, ducted outlet. Ratings include the effects of duct end correction.

\* Sound power level with unlined metal duct were obtained from the test in the reverberant room.  
Data are not licensed by AMCA.



# Performance Curve

AXV 400-150-10, 50 Hz

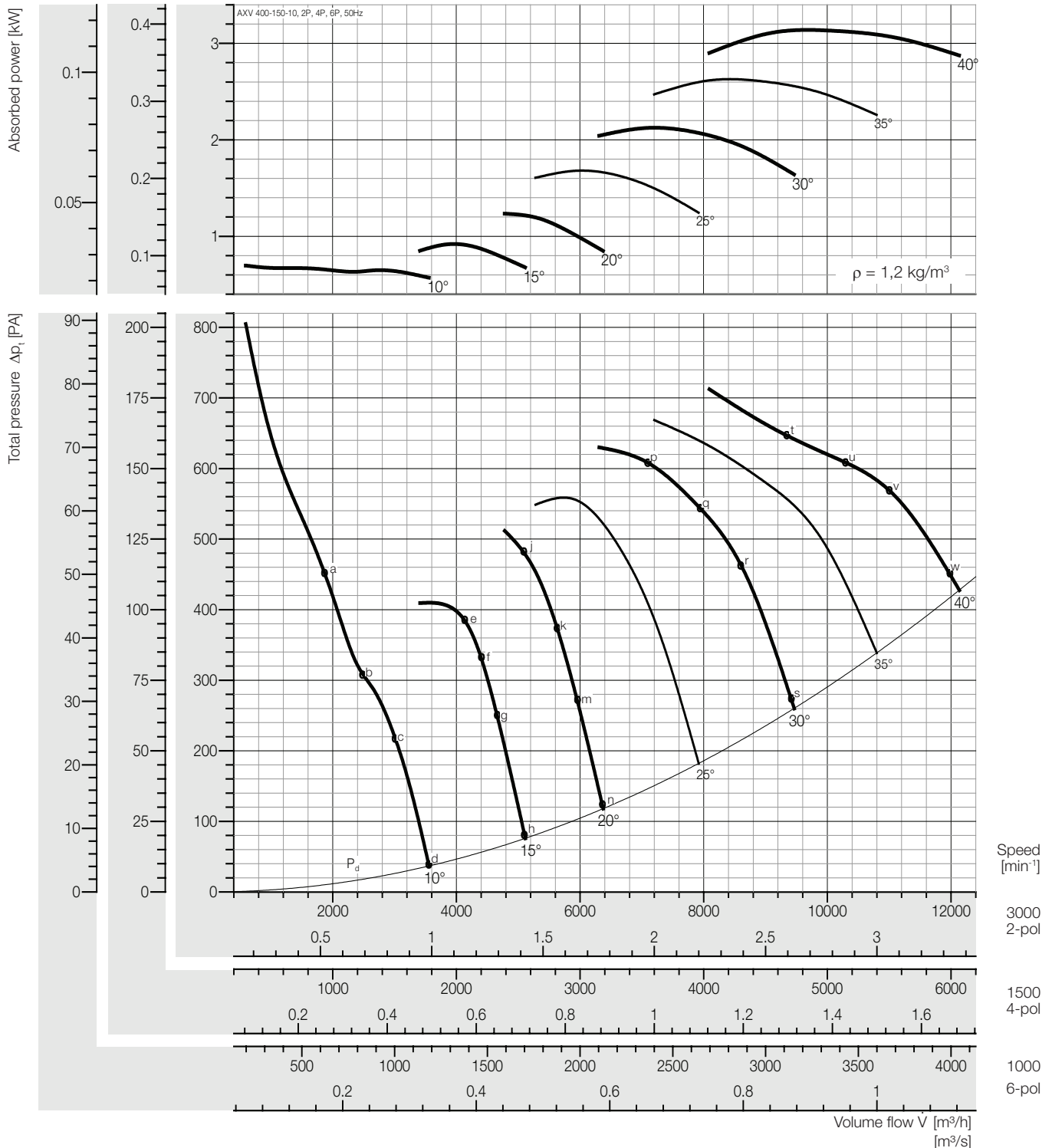

### Peak absorbed power [kW]

n [min <sup>-1</sup> ]	Pitch angle [°]								
	10	15	20	25	30	35	40		
1000	0,026	0,034	0,046	0,062	0,079	0,097	0,116		
Motor	0,18								
1500	0,087	0,115	0,154	0,210	0,265	0,329	0,392		
Motor	0,18						0,25	0,37	0,55
3000	0,697	0,920	1,235	1,678	2,123	2,629	3,137		
Motor	0,75	1,1	1,5	2,2	3,0		4		

### Sound power level, Lwi(A) [dB(A)]

Lwi(A)	a	b	c	d	e	f	g	h	j	k	m	n	p	q	r	s	t	u	v	w
2P	97	96	94	94	94	93	93	94	92	93	95	96	95	96	96	98	99	99	99	99
4P	78	78	77	77	76	75	76	77	74	76	77	78	77	78	80	80	80	80	81	82
6P	66	67	66	66	66	65	66	67	64	65	67	68	66	67	67	70	69	69	70	71

Plastic Duct

Lwi(A)	a	b	c	d	e	f	g	h	j	k	m	n	p	q	r	s	t	u	v	w
2P	95	94	92	92	92	91	91	92	90	91	93	94	93	94	94	96	97	97	97	97
4P	76	76	75	75	74	73	74	75	72	74	75	76	75	75	76	78	78	78	79	80
6P	64	65	64	64	64	63	64	65	62	63	65	66	64	65	65	68	67	67	68	69

\* Unlined Metal Duct

The A-weighted sound ratings shown have been calculated per AMCA International Standard 301. Values shown are for inlet Lwi(A) sound power levels for installation Type D: ducted inlet, ducted outlet. Ratings include the effects of duct end correction.

\* Sound power level with unlined metal duct were obtained from the test in the reverberant room. Data are not licensed by AMCA.



# Performance Curve

AXV 450-110-3, 50 Hz

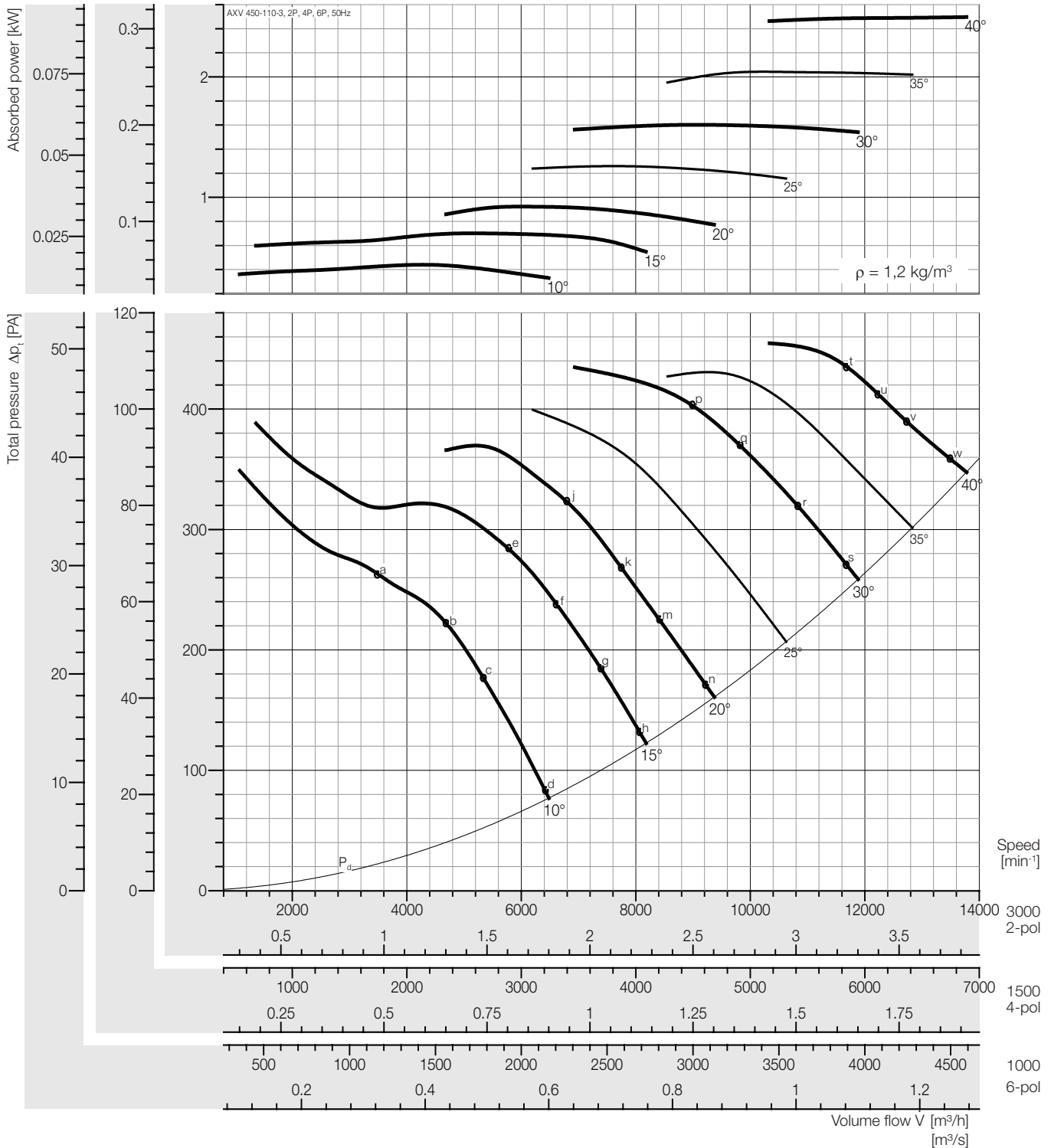

### Peak absorbed power [kW]

n [min <sup>-1</sup> ]	Pitch angle [°]							
	10	15	20	25	30	35	40	
1000	0,016	0,026	0,034	0,047	0,059	0,076	0,092	
Motor	0,18							
1500	0,055	0,088	0,115	0,157	0,200	0,255	0,312	
Motor	0,18						0,25	0,37
3000	0,439	0,701	0,922	1,259	1,602	2,042	2,497	
Motor	0,55	0,75	1,1	1,5	2,2	3,0		

### Sound power level, Lwi(A) [dB(A)]

Lwi(A)	a	b	c	d	e	f	g	h	j	k	m	n	p	q	r	s	t	u	v	w
2P	97	95	99	97	91	92	94	96	93	96	98	99	97	98	99	100	98	99	99	100
4P	79	78	82	77	73	73	74	75	74	75	76	77	78	78	78	79	79	79	79	80
6P	68	68	72	67	62	62	63	65	63	64	65	66	67	67	67	67	69	69	69	69

Plastic Duct

Lwi(A)	a	b	c	d	e	f	g	h	j	k	m	n	p	q	r	s	t	u	v	w
2P	95	93	97	95	89	90	92	94	91	94	96	97	95	96	97	98	96	97	97	98
4P	77	76	80	75	71	71	72	73	72	73	74	75	76	76	76	77	77	77	77	78
6P	66	66	70	65	60	60	61	63	61	62	63	64	65	65	65	65	67	67	67	67

\* Unlined Metal Duct

The A-weighted sound ratings shown have been calculated per AMCA International Standard 301. Values shown are for inlet LwiA sound power levels for installation Type D: ducted inlet, ducted outlet. Ratings include the effects of duct end correction.

\* Sound power level with unlined metal duct were obtained from the test in the reverberant room. Data are not licensed by AMCA.

Fan test laboratory AMCA 210 Test Chamber. Performance certified is for installation type D - Ducted inlet, Ducted outlet. Performance ratings do not include the effects of appurtenances (accessories-belt cover, pulley & belt).

Dimensions + Accessories Page 191 - 194;  
Sound power frequency spectrum L<sub>w</sub> Page 196 - 200.



# Performance Curve

AXV 450-110-6, 50 Hz

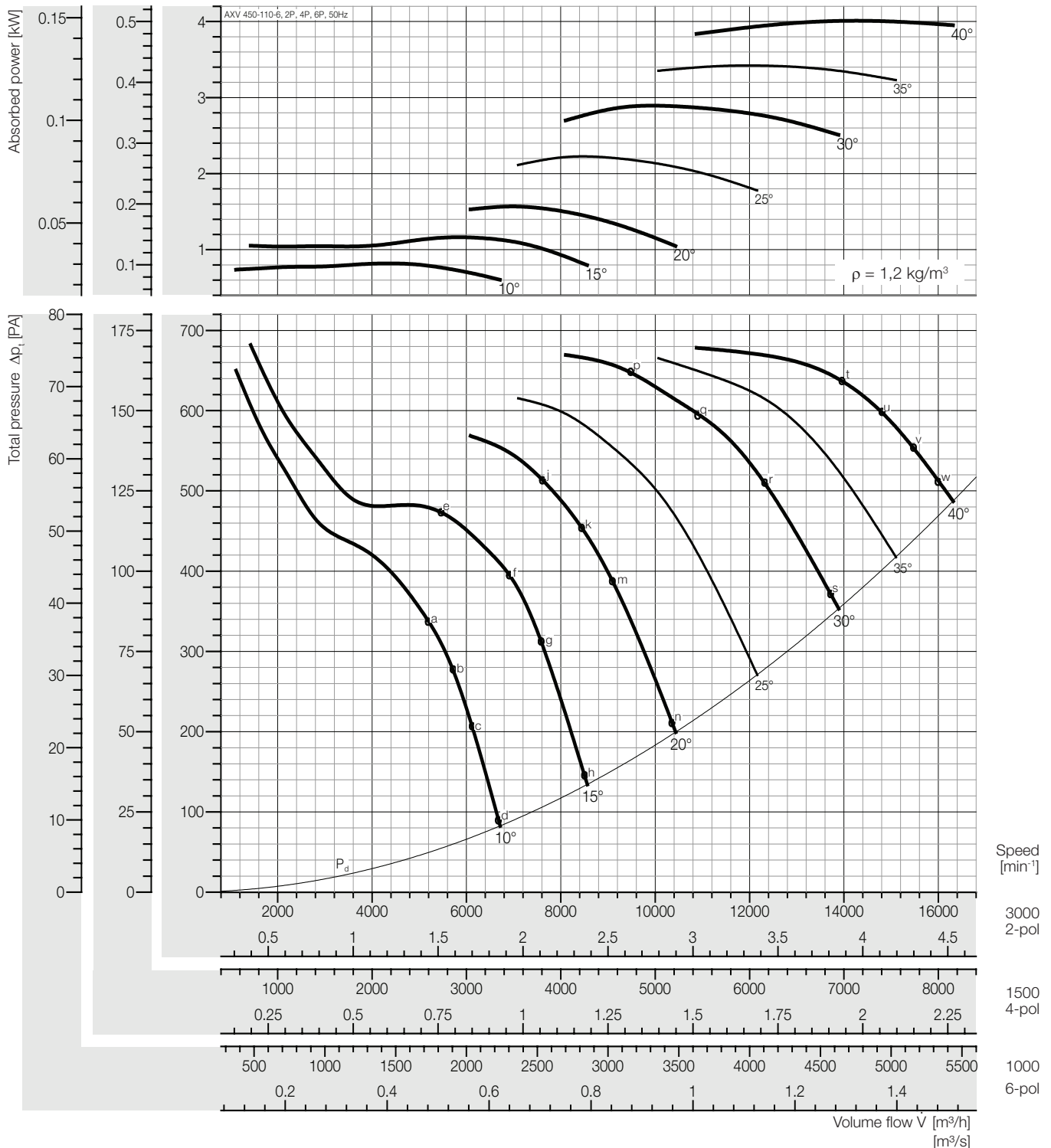

### Peak absorbed power [kW]

n [min <sup>-1</sup> ]	Pitch angle [°]						
	10	15	20	25	30	35	40
1000	0,030	0,043	0,058	0,082	0,107	0,127	0,148
Motor	0,18						
1500	0,102	0,145	0,196	0,278	0,362	0,428	0,501
Motor	0,18						
3000	0,818	1,158	1,568	2,223	2,894	3,421	4,009
Motor	1,1	1,5	2,2	3,0	4,0		

### Sound power level, Lwi(A) [dB(A)]

Lwi(A)	a	b	c	d	e	f	g	h	j	k	m	n	p	q	r	s	t	u	v	w
2P	96	93	94	96	100	96	96	97	97	97	98	98	96	97	97	98	109	111	111	110
4P	78	75	76	78	82	76	77	78	78	78	79	80	77	78	79	80	87	89	88	88
6P	68	65	66	68	71	66	67	68	68	68	69	72	67	67	68	69	78	80	79	79

Plastic Duct

Lwi(A)	a	b	c	d	e	f	g	h	j	k	m	n	p	q	r	s	t	u	v	w
2P	94	91	92	94	98	94	94	95	95	95	96	96	94	95	95	96	107	109	109	108
4P	76	73	74	76	80	74	75	76	76	76	77	78	75	76	77	78	85	87	86	86
6P	66	63	64	66	69	64	65	66	66	66	67	70	65	65	66	67	76	78	77	77

\* Unlined Metal Duct

Fan test laboratory AMCA 210 Test Chamber. Performance certified is for installation type D - Ducted inlet, Ducted outlet. Performance ratings do not include the effects of appurtenances (accessories-belt cover, pulley & belt).

Dimensions + Accessories Page 191 - 194;  
Sound power frequency spectrum L<sub>w</sub> Page 196 - 200.

The A-weighted sound ratings shown have been calculated per AMCA International Standard 301. Values shown are for inlet Lwi(A) sound power levels for installation Type D: ducted inlet, ducted outlet. Ratings include the effects of duct end correction.

\* Sound power level with unlined metal duct were obtained from the test in the reverberant room. Data are not licensed by AMCA.



# Performance Curve

AXV 450-150-5, 50 Hz

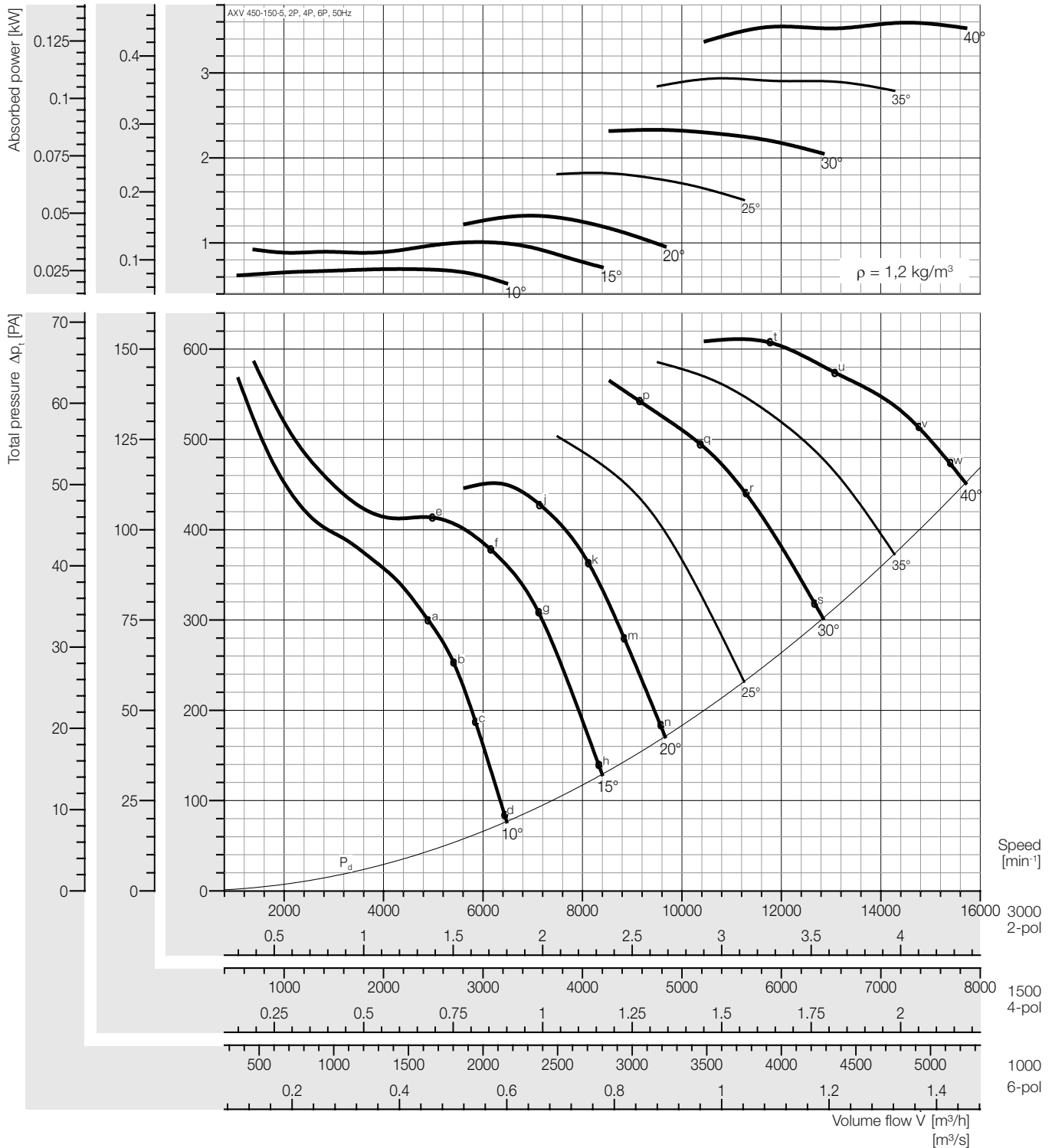

### Peak absorbed power [kW]

n [min <sup>-1</sup> ]	Pitch angle [°]								
	10	15	20	25	30	35	40		
1000	0,026	0,037	0,049	0,068	0,86	0,109	0,133		
Motor	0,18								
1500	0,086	0,126	0,165	0,228	0,291	0,367	0,449		
Motor	0,18						0,25	0,37	0,55
3000	0,692	1,009	1,321	1,824	2,331	2,932	3,592		
Motor	0,75	1,1	1,5	2,2	3,0	4,0			

### Sound power level, Lwi(A) [dB(A)]

Lwi(A)	a	b	c	d	e	f	g	h	j	k	m	n	p	q	r	s	t	u	v	w
2P	96	95	95	96	103	97	93	97	95	95	96	98	98	98	99	99	98	98	98	99
4P	79	77	78	79	84	79	76	78	77	77	78	79	79	80	80	81	81	81	80	81
6P	69	67	67	68	73	69	66	68	67	66	67	68	69	68	68	69	71	70	70	70

Plastic Duct

Lwi(A)	a	b	c	d	e	f	g	h	j	k	m	n	p	q	r	s	t	u	v	w
2P	94	93	93	94	101	95	91	95	93	93	94	96	96	96	97	97	96	96	96	97
4P	77	75	76	77	82	77	74	76	75	75	76	77	77	78	78	79	79	78	79	79
6P	67	65	65	66	71	67	64	66	65	64	65	66	67	66	66	67	69	68	68	68

\* Unlined Metal Duct

Fan test laboratory AMCA 210 Test Chamber. Performance certified is for installation type D - Ducted inlet, Ducted outlet. Performance ratings do not include the effects of appurtenances (accessories-belt cover, pulley & belt).

Dimensions + Accessories Page 191 - 194;

Sound power frequency spectrum L<sub>w</sub> Page 196 - 200.

The A-weighted sound ratings shown have been calculated per AMCA International Standard 301. Values shown are for inlet LwiA sound power levels for installation Type D: ducted inlet, ducted outlet. Ratings include the effects of duct end correction.

\* Sound power level with unlined metal duct were obtained from the test in the reverberant room. Data are not licensed by AMCA.



# Performance Curve

AXV 450-150-7, 50 Hz

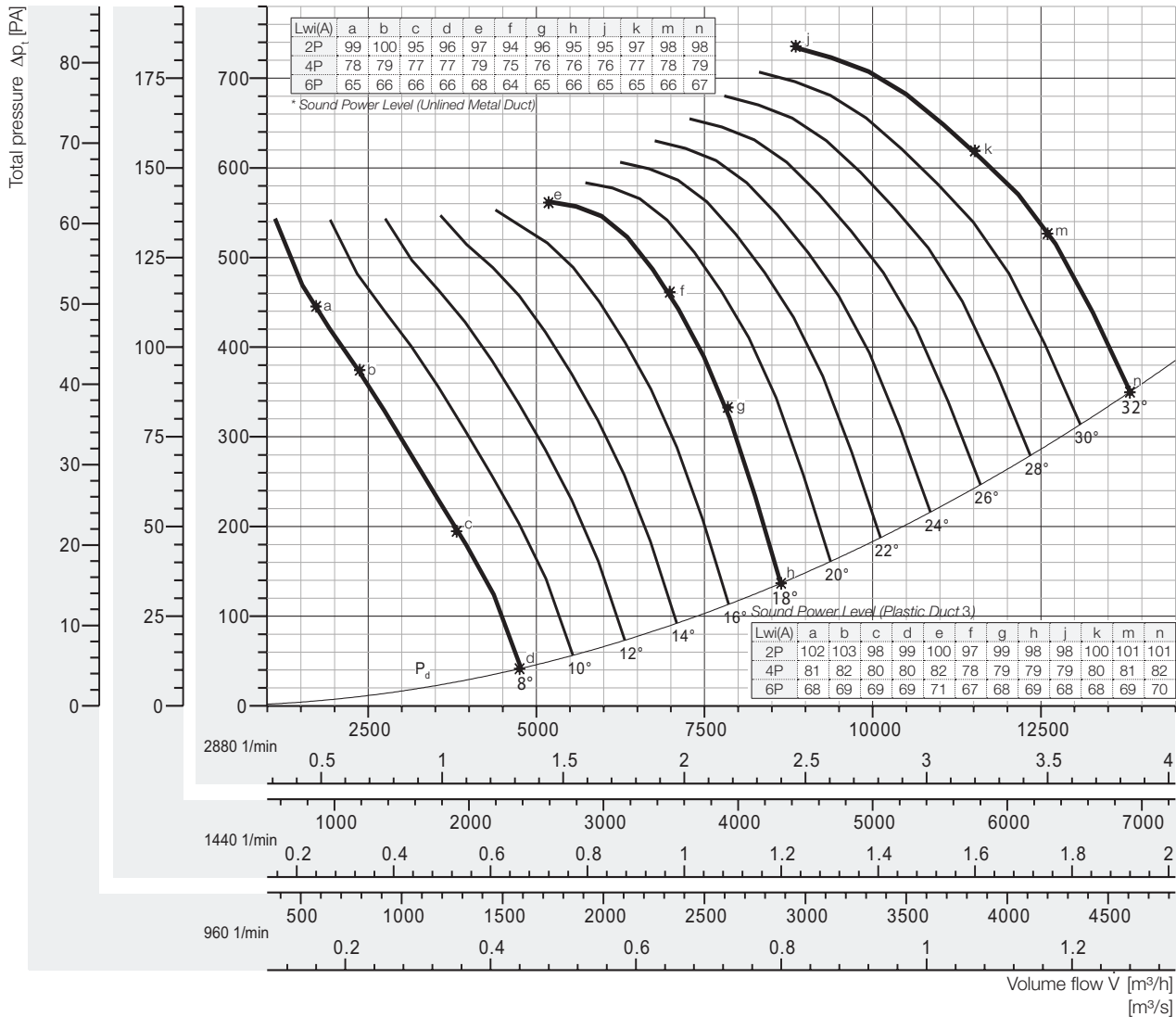
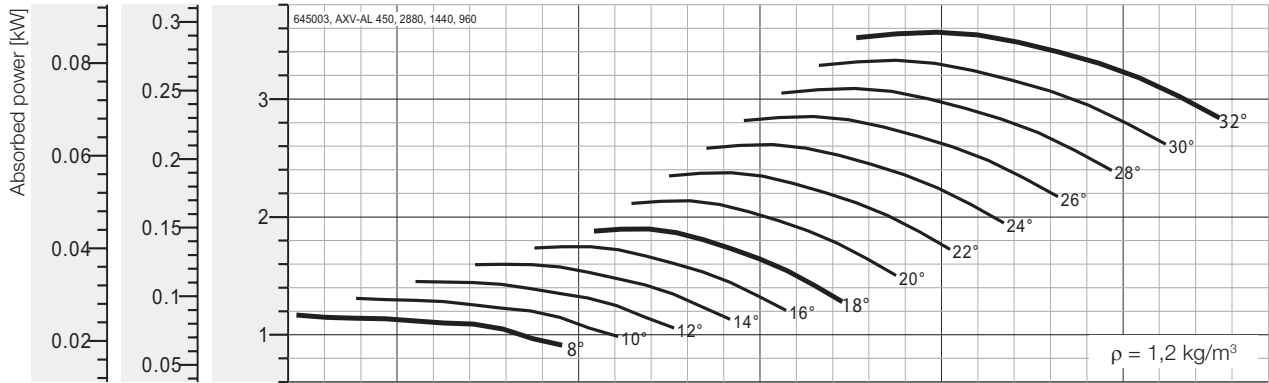

Speed [min<sup>-1</sup>]  
2880  
2-pol  
1440  
4-pol  
960  
6-pol

## Peak absorbed power [kW]

n [min <sup>-1</sup> ]	Pitch angle [°]																
	8	10	12	14	16	18	20	22	24	26	28	30	32	34	36	38	40
960 motor	0,043	0,049	0,054	0,059	0,065	0,070	0,079	0,088	0,097	0,106	0,114	0,123	0,132	-	-	-	-
	0,37																
1440 motor	0,146	0,164	0,182	0,200	0,218	0,237	0,267	0,297	0,327	0,356	0,386	0,416	0,446	-	-	-	-
	0,37																
												0,55					
2880 motor	1,17	1,31	1,45	1,60	1,75	1,90	2,14	2,38	2,61	2,852	3,09	3,33	3,567	-	-	-	-
				2,2					3								

Fan test laboratory AMCA 210 Test Chamber. Performance certified is for installation type D - Ducted inlet, Ducted outlet. Performance ratings do not include the effects of appurtenances (accessories-belt cover, pulley & belt).

Dimensions + Accessories Page 191 - 194;  
Sound power frequency spectrum L<sub>w</sub> Page 196 - 200.

The A-weighted sound ratings shown have been calculated per AMCA International Standard 301. Values shown are for inlet Lw(A) sound power levels for installation Type D: ducted inlet, ducted outlet. Ratings include the effects of duct end correction.

\* Sound power level with unlined metal duct were obtained from the test in the reverberant room. Data are not licensed by AMCA.





# Performance Curve

AXV 450-150-10, 50 Hz

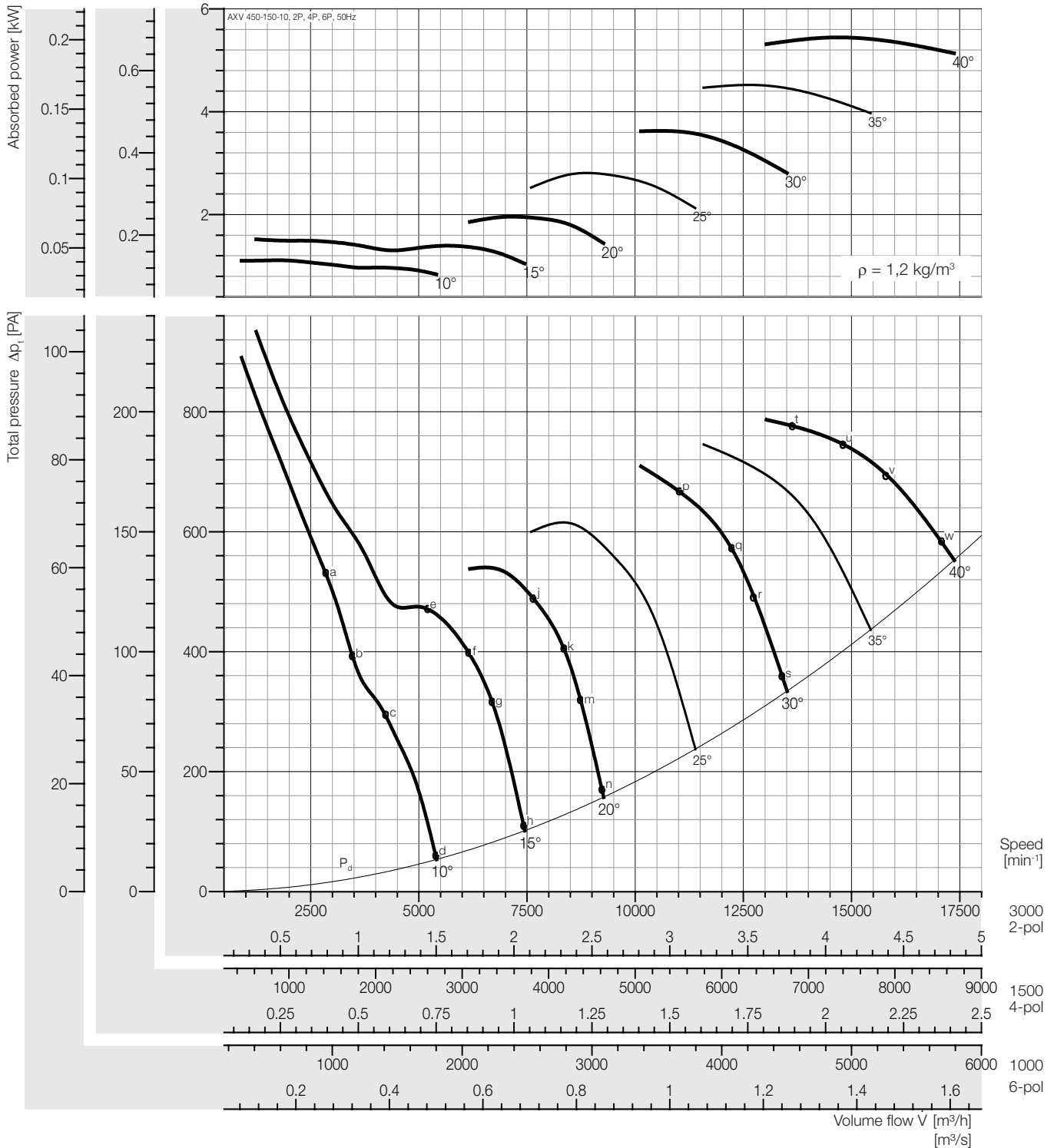

## Peak absorbed power [kW]

n [min <sup>-1</sup> ]	Pitch angle [°]						
	10	15	20	25	30	35	40
1000	0,041	0,052	0,072	0,104	0,135	0,168	0,201
Motor	0,18						0,25
1500	0,139	0,174	0,244	0,351	0,457	0,567	0,680
Motor	0,18		0,25	0,37	0,55	0,75	
3000	1,109	1,393	1,953	2,808	3,658	4,533	5,439
Motor	1,5		2,2	3,0	4,0	-	

## Sound power level, Lwi(A) [dB(A)]

Lwi(A)	a	b	c	d	e	f	g	h	j	k	m	n	p	q	r	s	t	u	v	w
2P	100	101	100	99	101	98	96	99	98	97	98	99	101	101	100	101	104	104	105	105
4P	82	83	83	81	84	82	79	82	81	80	81	82	83	83	83	83	85	85	86	87
6P	70	72	73	71	74	71	69	71	71	70	71	72	73	73	72	73	74	74	75	76

Plastic Duct

Lwi(A)	a	b	c	d	e	f	g	h	j	k	m	n	p	q	r	s	t	u	v	w
2P	98	99	98	97	99	96	94	97	96	95	96	97	99	99	98	99	102	102	103	103
4P	80	81	81	79	82	80	77	80	79	78	79	80	81	81	81	81	83	83	84	85
6P	68	70	71	69	72	69	67	69	69	68	69	70	71	71	70	71	72	72	73	74

\* Unlined Metal Duct

Fan test laboratory AMCA 210 Test Chamber. Performance certified is for installation type D - Ducted inlet, Ducted outlet. Performance ratings do not include the effects of appurtenances (accessories-belt cover, pulley & belt).

Dimensions + Accessories Page 191 - 194;

Sound power frequency spectrum L<sub>w</sub> Page 196 - 200.

The A-weighted sound ratings shown have been calculated per AMCA International Standard 301. Values shown are for inlet LwiA sound power levels for installation Type D: ducted inlet, ducted outlet. Ratings include the effects of duct end correction.

\* Sound power level with unlined metal duct were obtained from the test in the reverberant room. Data are not licensed by AMCA.



# Performance Curve

AXV 500-110-3, 50 Hz

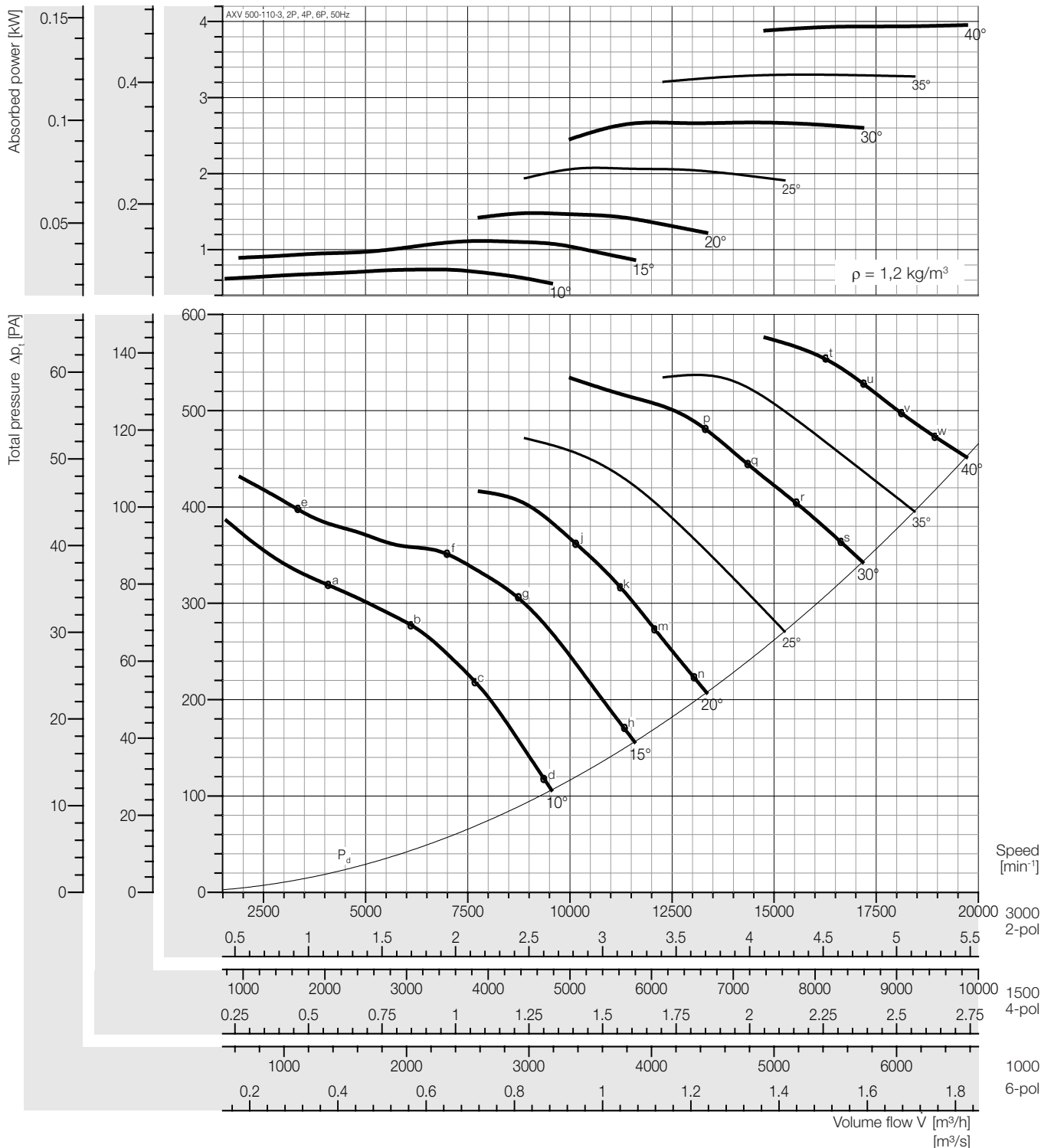

### Peak absorbed power [kW]

n [min <sup>-1</sup> ]	Pitch angle [°]							
	10	15	20	25	30	35	40	
1000	0,027	0,041	0,055	0,077	0,099	0,122	0,146	
Motor	0,18							
1500	0,092	0,139	0,185	0,259	0,334	0,413	0,494	
Motor	0,18						0,25	0,37
3000	0,739	1,109	1,481	2,072	2,671	3,302	3,954	
Motor	0,55	0,75	1,1	1,5	2,2	3,0		

### Sound power level, Lwi(A) [dB(A)]

Lwi(A)	a	b	c	d	e	f	g	h	j	k	m	n	p	q	r	s	t	u	v	w
2P	101	101	97	96	99	100	96	96	97	96	96	97	99	99	99	100	102	102	102	102
4P	82	83	79	79	81	83	78	78	79	79	79	79	81	81	81	81	84	84	84	84
6P	71	72	69	68	70	72	68	68	69	68	68	70	70	70	71	74	74	74	74	74

Plastic Duct

Lwi(A)	a	b	c	d	e	f	g	h	j	k	m	n	p	q	r	s	t	u	v	w
2P	99	99	95	94	97	98	94	94	95	94	94	95	97	97	97	98	100	100	100	100
4P	80	81	77	77	79	81	76	76	77	77	77	77	79	79	79	79	82	82	82	82
6P	69	70	67	66	68	70	66	66	67	66	66	66	68	68	68	69	72	72	72	72

\* Unlined Metal Duct

The A-weighted sound ratings shown have been calculated per AMCA International Standard 301. Values shown are for inlet Lwi(A) sound power levels for installation Type D: ducted inlet, ducted outlet. Ratings include the effects of duct end correction.

\* Sound power level with unlined metal duct were obtained from the test in the reverberant room. Data are not licensed by AMCA.



# Performance Curve

AXV 500-110-6, 50 Hz

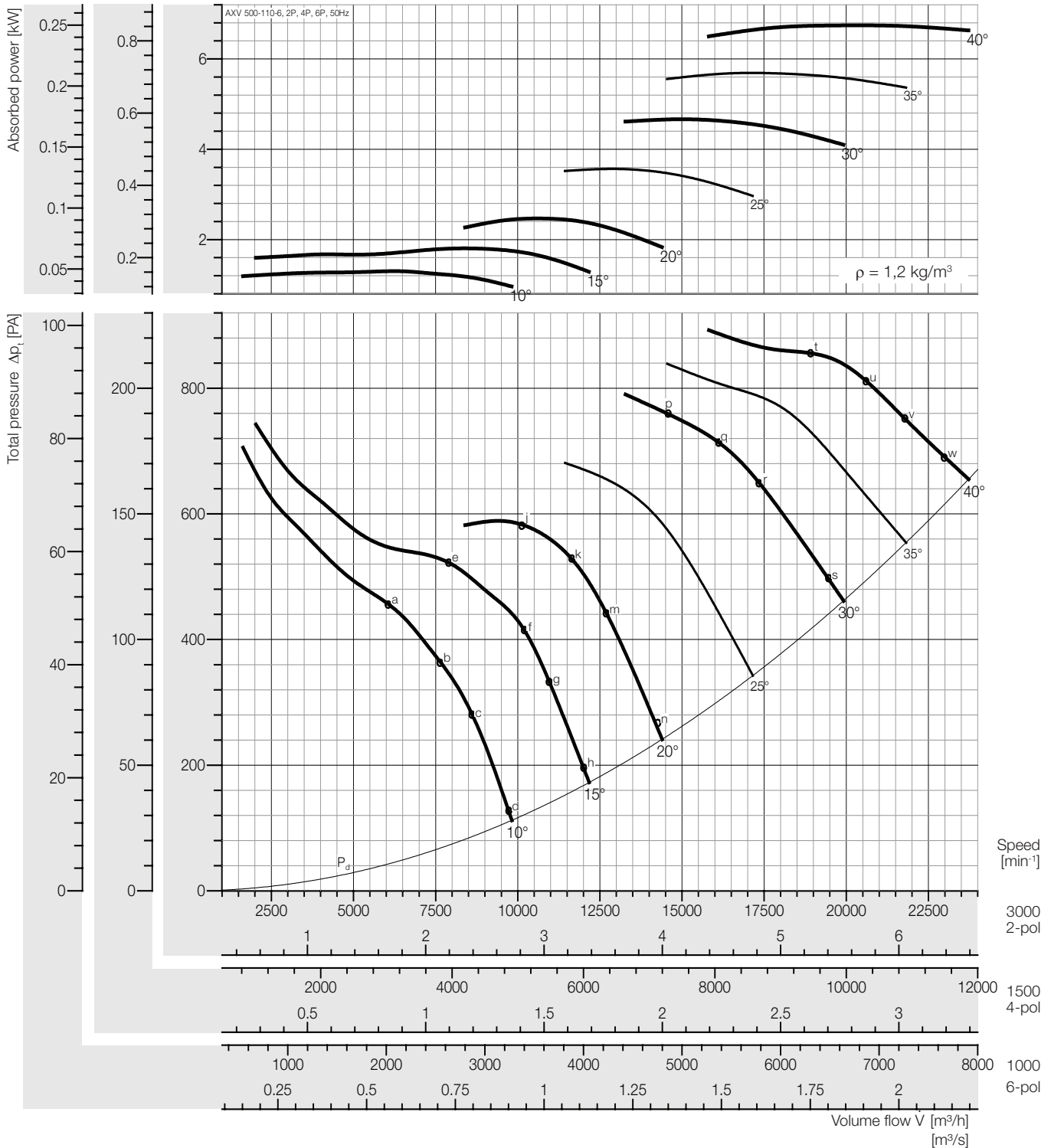

### Peak absorbed power [kW]

n [min <sup>-1</sup> ]	Pitch angle [°]						
	10	15	20	25	30	35	40
1000	0,048	0,067	0,091	0,132	0,173	0,211	0,250
Motor	0,18						0,25
1500	0,163	0,225	0,308	0,446	0,583	0,711	0,843
Motor	0,18	0,25	0,37	0,55	0,75	1,1	
3000	1,301	1,802	2,466	3,565	4,664	5,691	6,744
Motor	1,5	2,2	3,0	4,0	-		

### Sound power level, Lwi(A) [dB(A)]

Lwi(A)	a	b	c	d	e	f	g	h	j	k	m	n	p	q	r	s	t	u	v	w
2P	104	102	98	99	105	98	98	99	104	99	98	99	101	101	101	102	103	103	103	104
4P	86	85	80	82	87	80	81	81	86	82	81	82	83	83	83	84	85	85	85	86
6P	75	75	71	72	77	70	70	71	76	71	71	71	73	72	72	73	75	75	75	75

Plastic Duct

Lwi(A)	a	b	c	d	e	f	g	h	j	k	m	n	p	q	r	s	t	u	v	w
2P	102	100	96	97	103	96	96	97	102	97	96	97	99	99	99	100	101	101	101	102
4P	84	83	78	80	85	78	79	79	84	80	79	80	81	81	81	82	83	83	83	84
6P	73	73	69	70	75	68	68	79	74	69	69	69	71	70	70	71	73	73	73	73

\* Unlined Metal Duct

Fan test laboratory AMCA 210 Test Chamber. Performance certified is for installation type D - Ducted inlet, Ducted outlet. Performance ratings do not include the effects of appurtenances (accessories-belt cover, pulley & belt).

Dimensions + Accessories Page 191 - 194;

Sound power frequency spectrum L<sub>w</sub> Page 196 - 200.

The A-weighted sound ratings shown have been calculated per AMCA International Standard 301. Values shown are for inlet LwiA sound power levels for installation Type D: ducted inlet, ducted outlet. Ratings include the effects of duct end correction.

\* Sound power level with unlined metal duct were obtained from the test in the reverberant room. Data are not licensed by AMCA.



# Performance Curve

AXV 500-150-5, 50 Hz

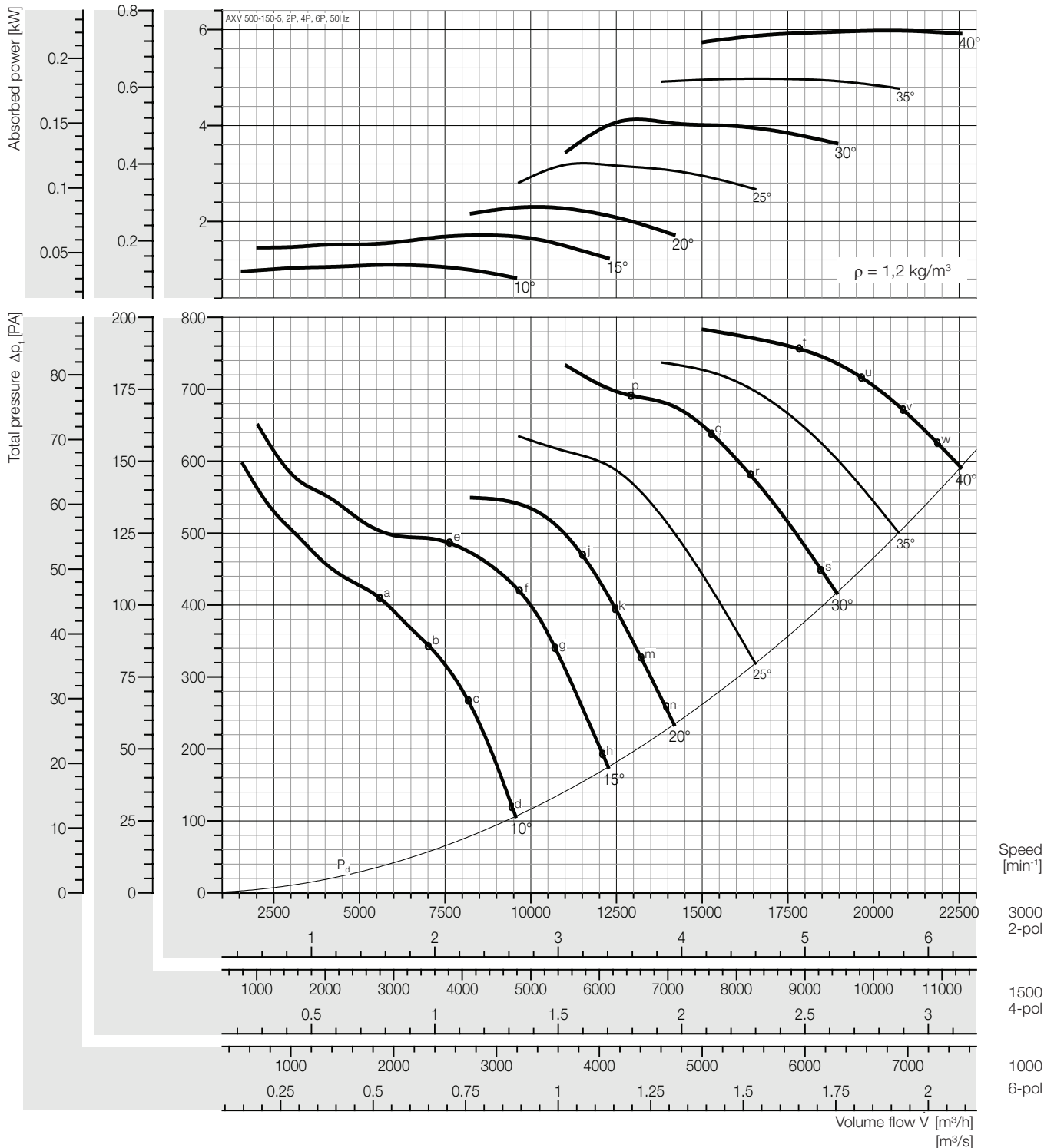

### Peak absorbed power [kW]

n [min <sup>-1</sup> ]	Pitch angle [°]						
	10	15	20	25	30	35	40
1000	0,041	0,063	0,085	0,119	0,152	0,184	0,221
Motor	0,18					0,25	
1500	0,137	0,214	0,288	0,400	0,514	0,622	0,747
Motor	0,18	0,25	0,37	0,55	0,75		1,1
3000	1,096	1,712	2,304	3,200	4,112	4,976	5,979
Motor	1,1	2,2	3,0	4,0	-		

### Sound power level, Lwi(A) [dB(A)]

Lwi(A)	a	b	c	d	e	f	g	h	j	k	m	n	p	q	r	s	t	u	v	w
2P	103	102	99	99	105	99	99	101	101	102	103	103	102	102	103	104	103	104	104	104
4P	85	85	81	81	87	81	80	82	82	82	83	83	83	84	84	85	86	86	86	86
6P	74	74	70	70	76	70	70	71	71	71	72	72	72	73	73	73	75	75	75	75

Plastic Duct

Lwi(A)	a	b	c	d	e	f	g	h	j	k	m	n	p	q	r	s	t	u	v	w
2P	101	100	97	97	103	97	97	99	99	100	101	101	100	100	101	102	101	102	102	102
4P	83	83	79	79	85	79	78	80	80	80	81	81	81	82	82	83	84	84	84	84
6P	72	72	68	68	74	68	68	69	69	69	70	70	70	71	71	71	73	73	73	73

\* Unlined Metal Duct

Fan test laboratory AMCA 210 Test Chamber. Performance certified is for installation type D - Ducted inlet, Ducted outlet. Performance ratings do not include the effects of appurtenances (accessories-belt cover, pulley & belt).

Dimensions + Accessories Page 191 - 194;  
Sound power frequency spectrum L<sub>w</sub> Page 196 - 200.

The A-weighted sound ratings shown have been calculated per AMCA International Standard 301. Values shown are for inlet Lwi(A) sound power levels for installation Type D: ducted inlet, ducted outlet. Ratings include the effects of duct end correction.

\* Sound power level with unlined metal duct were obtained from the test in the reverberant room. Data are not licensed by AMCA.



# Performance Curve

AXV 500-150-7, 50 Hz

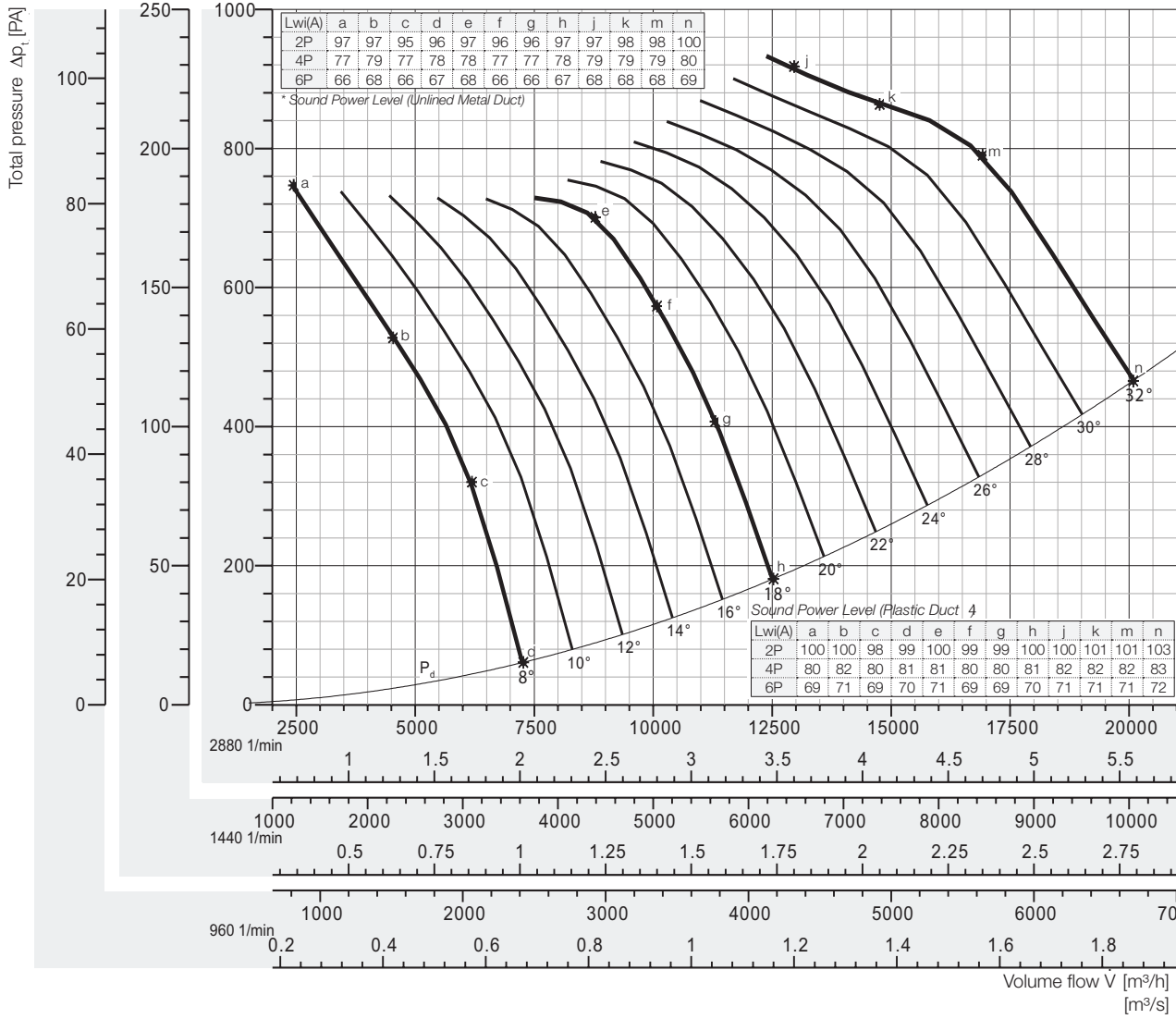
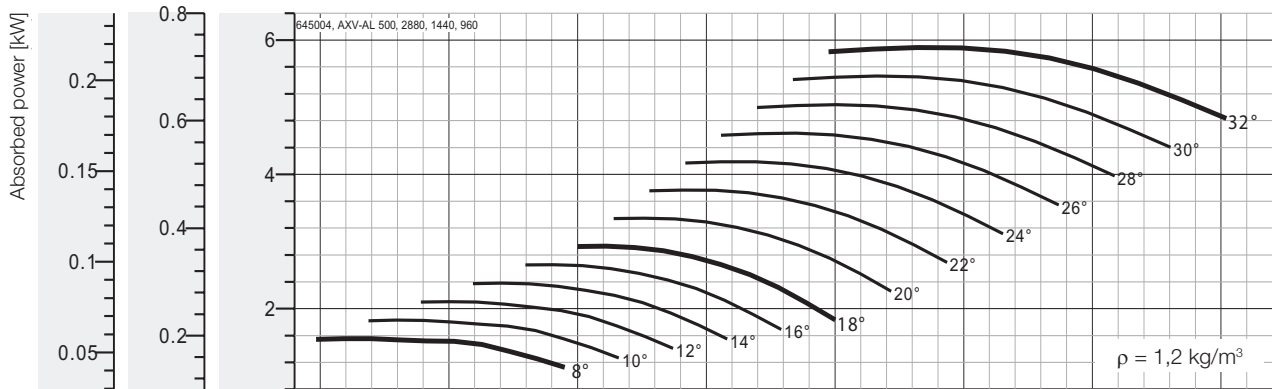

## Peak absorbed power [kW]

\* Out of Range

n [min <sup>-1</sup> ]	Pitch angle [°]																
	8	10	12	14	16	18	20	22	24	26	28	30	32	34	36	38	40
960 motor	0,058	0,068	0,078	0,088	0,098	0,108	0,124	0,141	0,155	0,171	0,187	0,202	0,218	-	-	-	-
1440 motor	0,194	0,228	0,262	0,297	0,331	0,366	0,419	0,471	0,524	0,577	0,630	0,683	0,736	-	-	-	-
2880 motor	1,55	1,83	2,10	2,37	2,65	2,93	3,35	3,77	4,19	4,61	5,04	5,46	5,89	-	-	-	-

Fan test laboratory AMCA 210 Test Chamber. Performance certified is for installation type D - Ducted inlet, Ducted outlet. Performance ratings do not include the effects of appurtenances (accessories-belt cover, pulley & belt).  
 Dimensions + Accessories Page 191 ~ 194;  
 Sound power frequency spectrum L<sub>w</sub> Page 196 ~ 200.

The A-weighted sound ratings shown have been calculated per AMCA International Standard 301. Values shown are for inlet LwA sound power levels for installation Type D: ducted inlet, ducted outlet. Ratings include the effects of duct end correction.  
 \* Sound power level with unlined metal duct were obtained from the test in the reverberant room.  
 Data are not licensed by AMCA.



# Performance Curve

AXV 500-150-10, 50 Hz

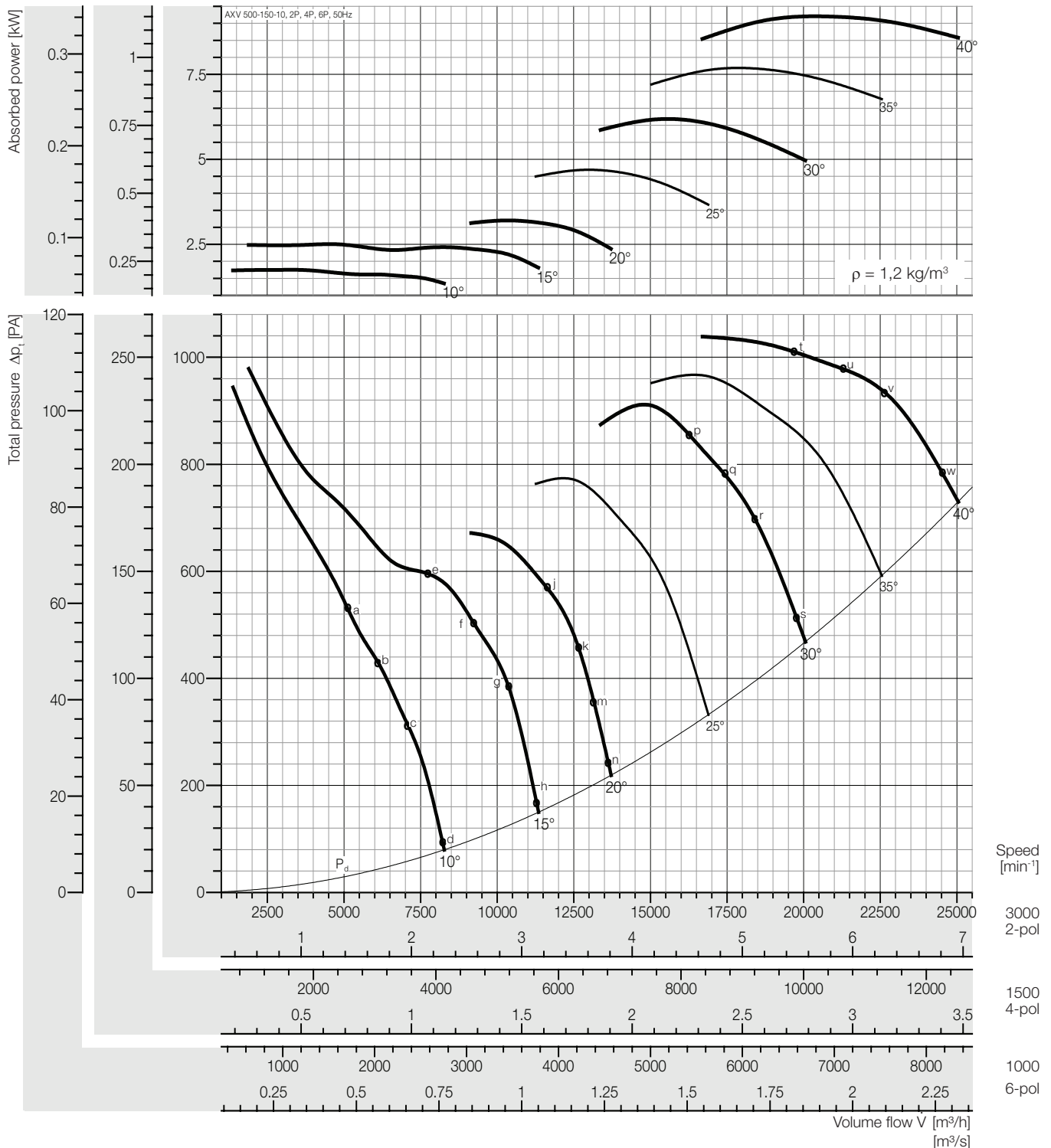

### Peak absorbed power [kW]

n [min <sup>-1</sup> ]	Pitch angle [°]						
	10	15	20	25	30	35	40
1000	0,065	0,089	0,119	0,174	0,229	0,284	0,341
Motor	0,18				0,25	0,37	
1500	0,219	0,302	0,400	0,586	0,773	0,960	1,151
Motor	0,25	0,37	0,55	0,75	1,1	1,5	
3000	1,749	2,415	3,204	4,692	6,187	7,681	9,979
Motor	2,2	3,0	4,0	-			

### Sound power level, Lwi(A) [dB(A)]

Lwi(A)	a	b	c	d	e	f	g	h	j	k	m	n	p	q	r	s	t	u	v	w
2P	103	103	103	102	105	103	100	102	102	103	104	105	104	104	104	106	105	106	106	106
4P	85	86	86	85	87	86	83	85	85	85	86	86	86	87	86	88	87	88	88	88
6P	74	76	76	74	77	75	72	74	74	74	75	75	76	76	75	77	76	77	77	77

Plastic Duct

Lwi(A)	a	b	c	d	e	f	g	h	j	k	m	n	p	q	r	s	t	u	v	w
2P	101	101	101	100	103	101	98	100	100	101	102	103	102	102	102	104	103	104	104	104
4P	83	84	84	83	85	84	81	83	83	83	84	84	84	85	84	86	85	86	86	86
6P	72	74	74	72	75	73	70	72	72	72	73	73	74	74	73	75	74	75	75	75

\* Unlined Metal Duct

Fan test laboratory AMCA 210 Test Chamber. Performance certified is for installation type D - Ducted inlet, Ducted outlet. Performance ratings do not include the effects of appurtenances (accessories-belt cover, pulley & belt).

Dimensions + Accessories Page 191 - 194;  
Sound power frequency spectrum L<sub>wnd</sub> Page 196 - 200.

The A-weighted sound ratings shown have been calculated per AMCA International Standard 301. Values shown are for inlet Lwi(A) sound power levels for installation Type D: ducted inlet, ducted outlet. Ratings include the effects of duct end correction.

\* Sound power level with unlined metal duct were obtained from the test in the reverberant room. Data are not licensed by AMCA.



# Performance Curve

AXV 500-250-7, 50 Hz

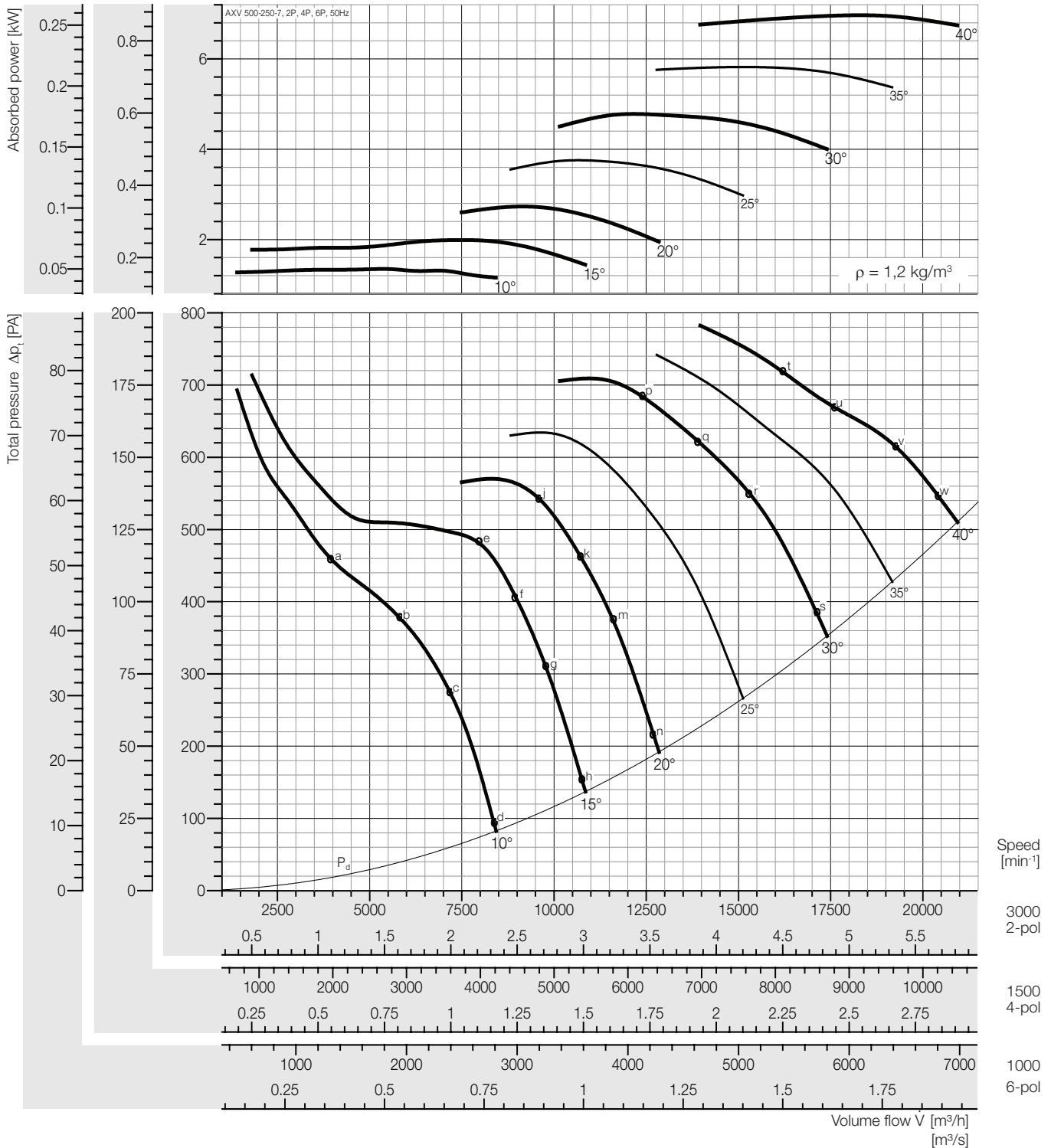

### Peak absorbed power [kW]

n [min <sup>-1</sup> ]	Pitch angle [°]						
	10	15	20	25	30	35	40
1000	0,050	0,074	0,101	0,139	0,177	0,216	0,258
Motor	0,18					0,25	0,37
1500	0,169	0,248	0,341	0,469	0,597	0,728	0,871
Motor	0,25		0,37	0,55	0,75		1,1
3000	1,349	1,986	2,731	3,753	4,774	5,821	6,966
Motor	1,5	2,2	3,0	4,0	-		

### Sound power level, Lwi(A) [dB(A)]

Lwi(A)	a	b	c	d	e	f	g	h	j	k	m	n	p	q	r	s	t	u	v	w
2P	104	103	98	101	103	99	99	100	100	99	99	101	102	103	102	104	105	105	105	106
4P	85	87	81	83	86	82	81	83	82	81	81	82	84	84	84	85	86	87	87	87
6P	74	76	71	73	75	72	71	72	72	71	71	72	74	74	73	75	76	76	76	77

Plastic Duct

Lwi(A)	a	b	c	d	e	f	g	h	j	k	m	n	p	q	r	s	t	u	v	w
2P	102	101	96	99	101	97	97	98	98	97	97	99	100	101	100	102	103	103	103	104
4P	83	85	79	81	84	80	79	81	80	79	79	80	82	82	82	83	84	85	85	85
6P	72	74	69	71	73	70	69	70	70	69	69	70	72	72	71	73	74	74	74	75

\* Unlined Metal Duct

Fan test laboratory AMCA 210 Test Chamber. Performance certified is for installation type D - Ducted inlet, Ducted outlet. Performance ratings do not include the effects of appurtenances (accessories-belt cover, pulley & belt).

Dimensions + Accessories Page 191 - 194;

Sound power frequency spectrum L<sub>w</sub> Page 196 - 200.

The A-weighted sound ratings shown have been calculated per AMCA International Standard 301. Values shown are for inlet LwiA sound power levels for installation Type D: ducted inlet, ducted outlet. Ratings include the effects of duct end correction.

\* Sound power level with unlined metal duct were obtained from the test in the reverberant room. Data are not licensed by AMCA.



# Performance Curve

AXV 560-110-3, 50 Hz

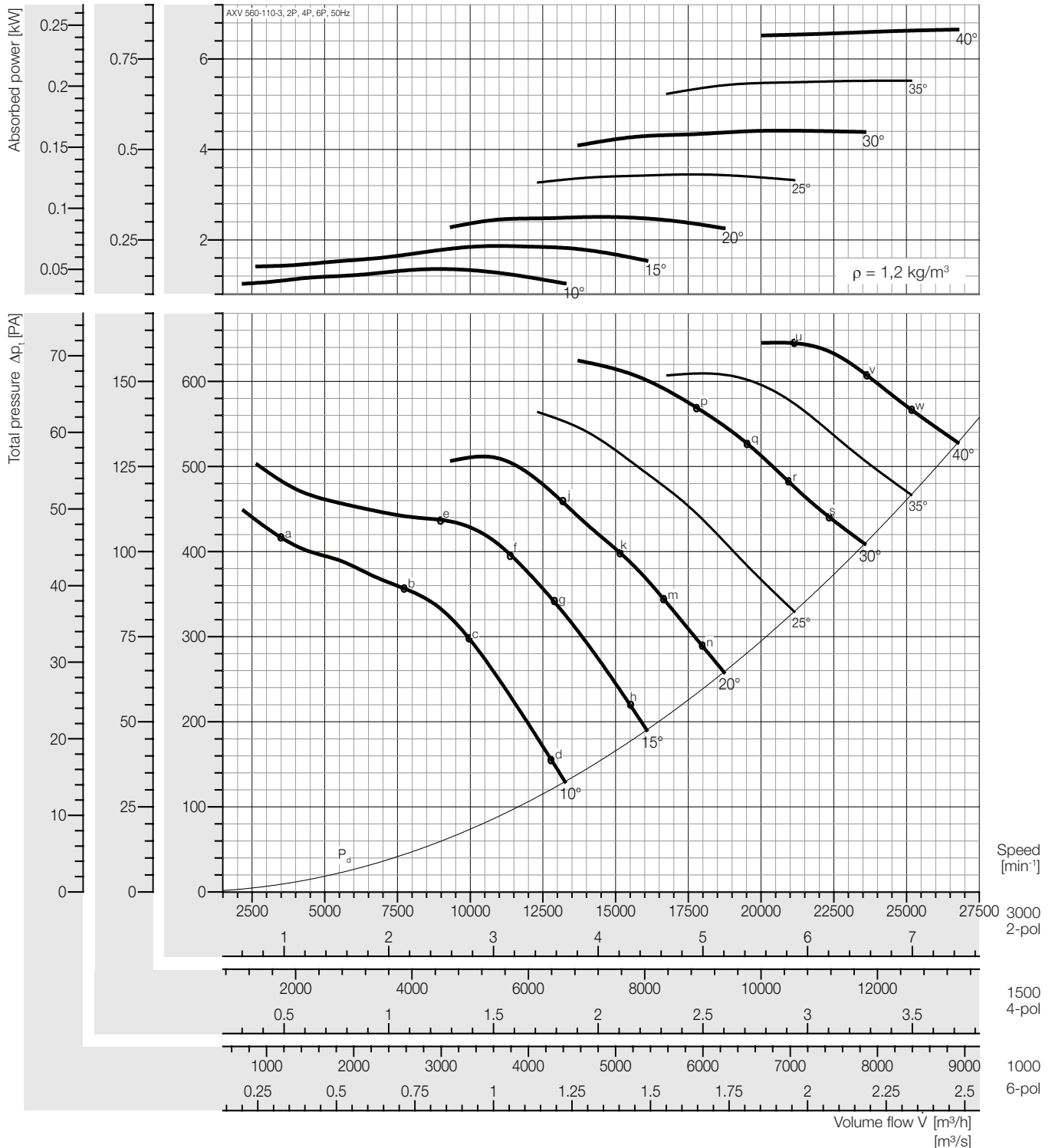

## Peak absorbed power [kW]

n [min <sup>-1</sup> ]	Pitch angle [°]						
	10	15	20	25	30	35	40
1000	0,050	0,069	0,093	0,128	0,164	0,204	0,246
Motor	0,18					0,25	
1500	0,169	0,232	0,313	0,431	0,552	0,690	0,831
Motor	0,25		0,37	0,55	0,75		1,1
3000	1,348	1,860	2,508	3,446	4,416	5,520	6,652
Motor	1,5	2,2	3,0	4,0	-		

## Sound power level, Lwi(A) [dB(A)]

Lwi(A)	a	b	c	d	e	f	g	h	j	k	m	n	p	q	r	s	t	u	v	w
2P	106	104	104	103	104	102	102	103	103	103	103	104	103	103	104	107	-	105	106	106
4P	86	86	85	84	85	83	83	84	85	85	85	85	85	85	85	89	-	88	88	89
6P	74	76	75	74	75	72	72	73	74	74	74	75	74	74	75	79	-	77	78	78

Plastic Duct

Lwi(A)	a	b	c	d	e	f	g	h	j	k	m	n	p	q	r	s	t	u	v	w
2P	104	102	102	101	102	100	100	101	101	101	101	102	101	101	102	105	-	103	104	104
4P	84	84	83	82	83	81	81	82	83	83	83	83	83	83	83	87	-	86	86	87
6P	72	74	73	72	73	70	70	71	72	72	72	73	72	72	73	77	-	75	76	76

\* Unlined Metal Duct

Fan test laboratory AMCA 210 Test Chamber. Performance certified is for installation type D - Ducted inlet, Ducted outlet. Performance ratings do not include the effects of appurtenances (accessories-belt cover, pulley & belt).

Dimensions + Accessories Page 191 - 194;  
Sound power frequency spectrum L<sub>wnd</sub> Page 196 - 200.

The A-weighted sound ratings shown have been calculated per AMCA International Standard 301. Values shown are for inlet Lwi(A) sound power levels for installation Type D: ducted inlet, ducted outlet. Ratings include the effects of duct end correction.

\* Sound power level with unlined metal duct were obtained from the test in the reverberant room. Data are not licensed by AMCA.





# Performance Curve

AXV 560-110-6, 50 Hz

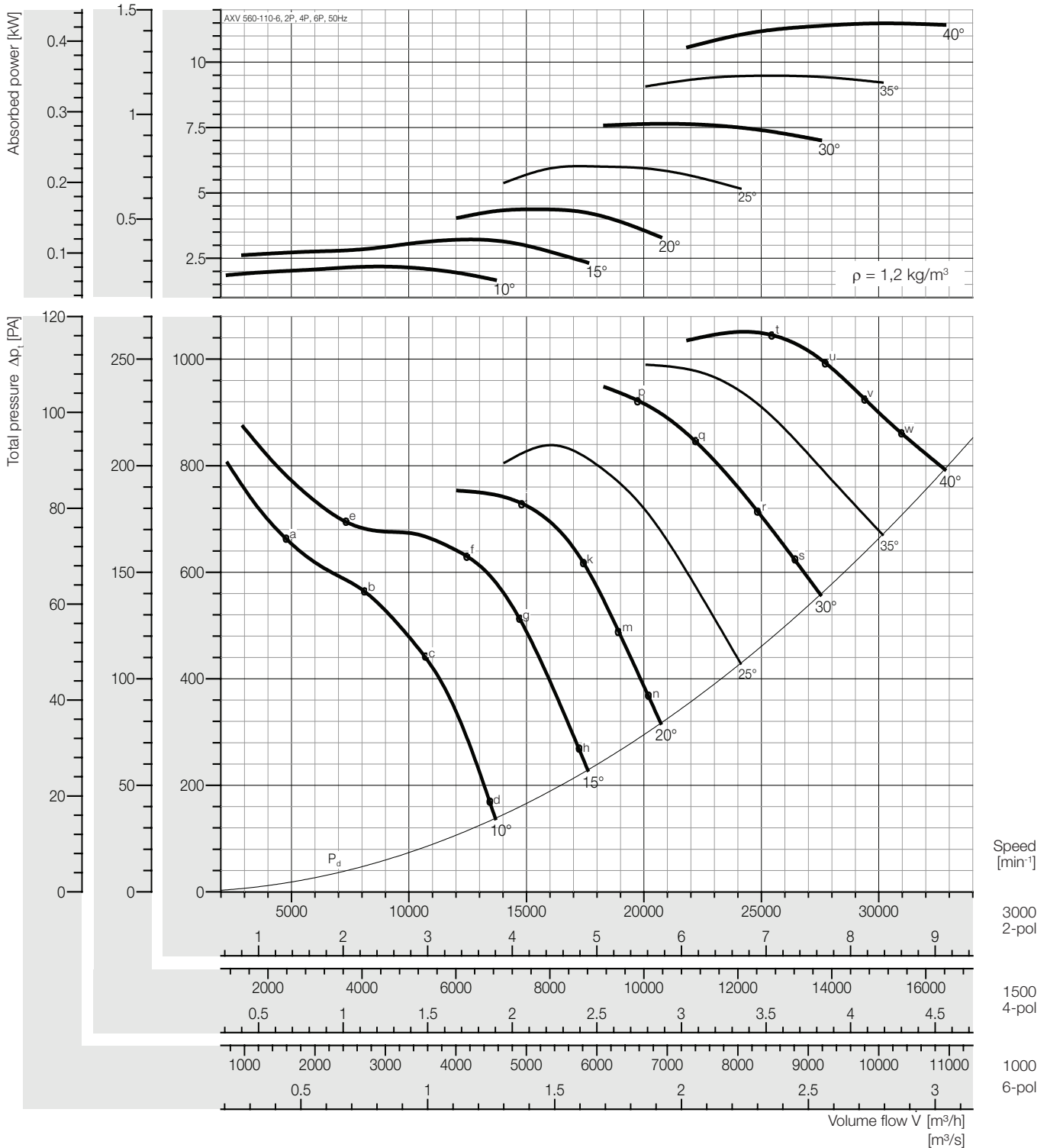

### Peak absorbed power [kW]

n [min <sup>-1</sup> ]	Pitch angle [°]						
	10	15	20	25	30	35	40
1000	0,081	0,119	0,162	0,223	0,283	0,351	0,425
Motor	0,25				0,37		0,55
1500	0,273	0,402	0,546	0,753	0,955	1,185	1,435
Motor	0,37	0,55	1,1		1,5		
3000	2,183	3,219	4,371	6,021	7,641	9,481	11,48
Motor	2,2	4,0	-				

### Sound power level, Lwi(A) [dB(A)]

Lwi(A)	a	b	c	d	e	f	g	h	j	k	m	n	p	q	r	s	t	u	v	w
2P	109	109	107	106	109	107	104	104	107	106	106	107	105	105	106	106	107	107	107	107
4P	92	93	91	90	89	90	86	86	88	87	87	88	87	88	88	88	90	90	90	90
6P	83	83	81	80	79	79	76	76	78	77	77	78	77	77	78	78	80	79	80	79

Plastic Duct

Lwi(A)	a	b	c	d	e	f	g	h	j	k	m	n	p	q	r	s	t	u	v	w
2P	107	107	105	104	107	105	102	102	105	104	104	105	103	103	104	104	105	105	105	105
4P	90	91	89	88	87	88	84	84	86	85	85	86	85	86	86	86	88	88	88	88
6P	83	81	79	78	77	77	74	74	76	75	75	76	75	75	76	76	78	77	78	77

\* Unlined Metal Duct

Fan test laboratory AMCA 210 Test Chamber. Performance certified is for installation type D - Ducted inlet, Ducted outlet. Performance ratings do not include the effects of appurtenances (accessories-belt cover, pulley & belt).

Dimensions + Accessories Page 191 - 194;

Sound power frequency spectrum L<sub>w</sub> Page 196 - 200.

The A-weighted sound ratings shown have been calculated per AMCA International Standard 301. Values shown are for inlet Lwi(A) sound power levels for installation Type D: ducted inlet, ducted outlet. Ratings include the effects of duct end correction.

\* Sound power level with unlined metal duct were obtained from the test in the reverberant room. Data are not licensed by AMCA.



# Performance Curve

AXV 560-150-5, 50 Hz

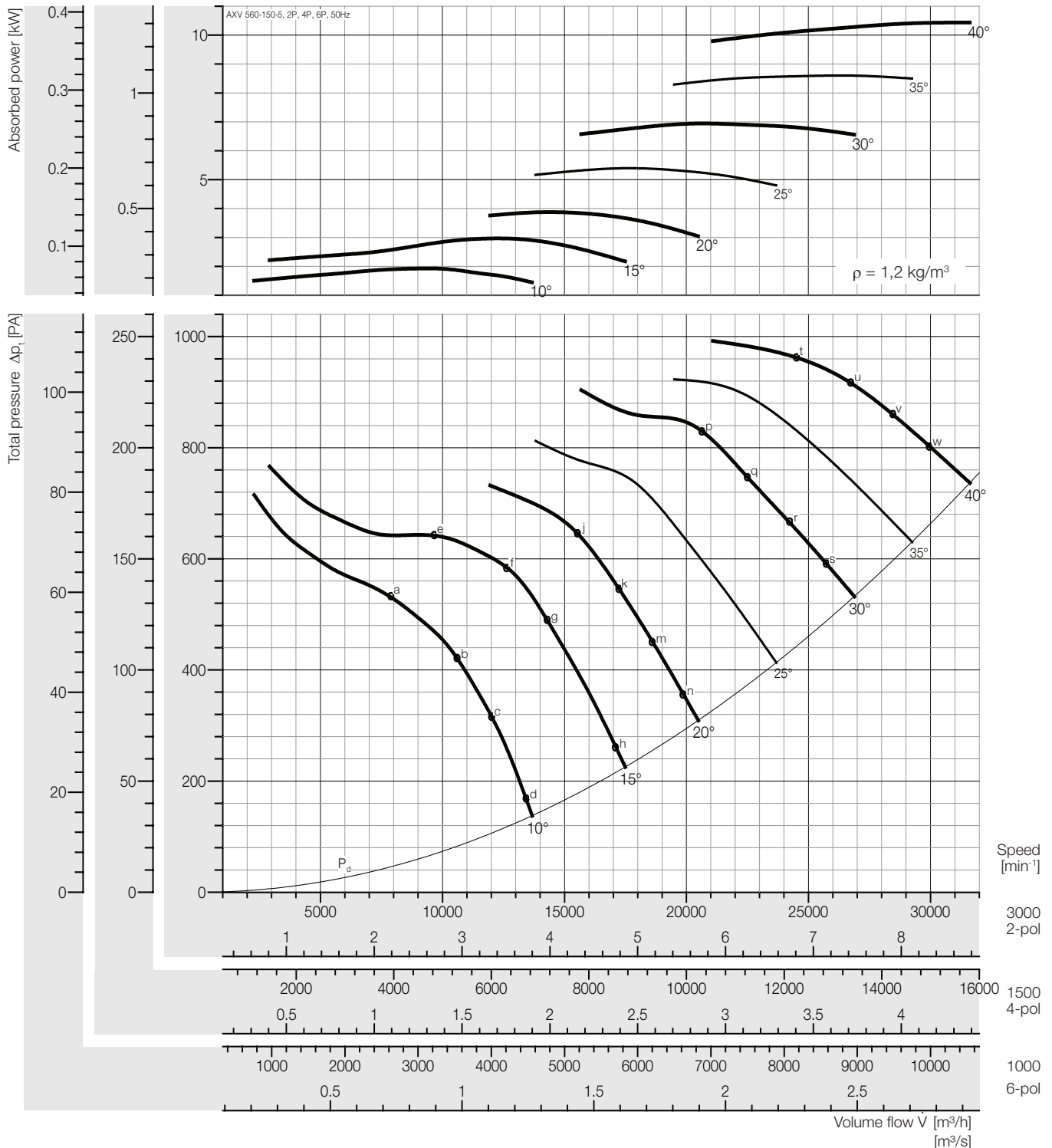

## Peak absorbed power [kW]

n [min <sup>-1</sup> ]	Pitch angle [°]						
	10	15	20	25	30	35	40
1000	0,071	0,110	0,143	0,200	0,257	0,319	0,387
Motor	0,25				0,37		0,55
1500	0,240	0,370	0,484	0,674	0,868	1,075	1,305
Motor	0,37		0,55	0,75	1,1		1,5
3000	1,920	2,961	3,873	5,390	6,942	8,603	10,44
Motor	2,2	3,0	4,0	-			

## Sound power level, Lwi(A) [dB(A)]

Lwi(A)	a	b	c	d	e	f	g	h	j	k	m	n	p	q	r	s	t	u	v	w
2P	109	107	106	106	108	104	105	107	104	104	104	104	105	105	105	106	108	109	109	109
4P	92	90	89	89	91	86	88	91	85	85	85	86	88	87	87	88	89	90	90	90
6P	82	80	79	79	80	75	78	81	74	74	75	75	77	77	76	77	79	79	79	79

Plastic Duct

Lwi(A)	a	b	c	d	e	f	g	h	j	k	m	n	p	q	r	s	t	u	v	w
2P	107	105	104	104	106	102	103	105	102	102	102	102	103	103	103	104	106	107	107	107
4P	90	88	87	87	89	84	86	89	83	83	83	84	86	85	85	86	87	88	88	88
6P	80	78	77	77	78	73	76	79	72	72	73	73	75	75	74	75	77	77	77	77

\* Unlined Metal Duct

Fan test laboratory AMCA 210 Test Chamber. Performance certified is for installation type D - Ducted inlet, Ducted outlet. Performance ratings do not include the effects of appurtenances (accessories-belt cover, pulley & belt).

Dimensions + Accessories Page 191 - 194;  
Sound power frequency spectrum L<sub>w</sub> Page 196 - 200.

The A-weighted sound ratings shown have been calculated per AMCA International Standard 301. Values shown are for inlet Lwi(A) sound power levels for installation Type D: ducted inlet, ducted outlet. Ratings include the effects of duct end correction.

\* Sound power level with unlined metal duct were obtained from the test in the reverberant room. Data are not licensed by AMCA.



# Performance Curve

AXV 560-150-10, 50 Hz

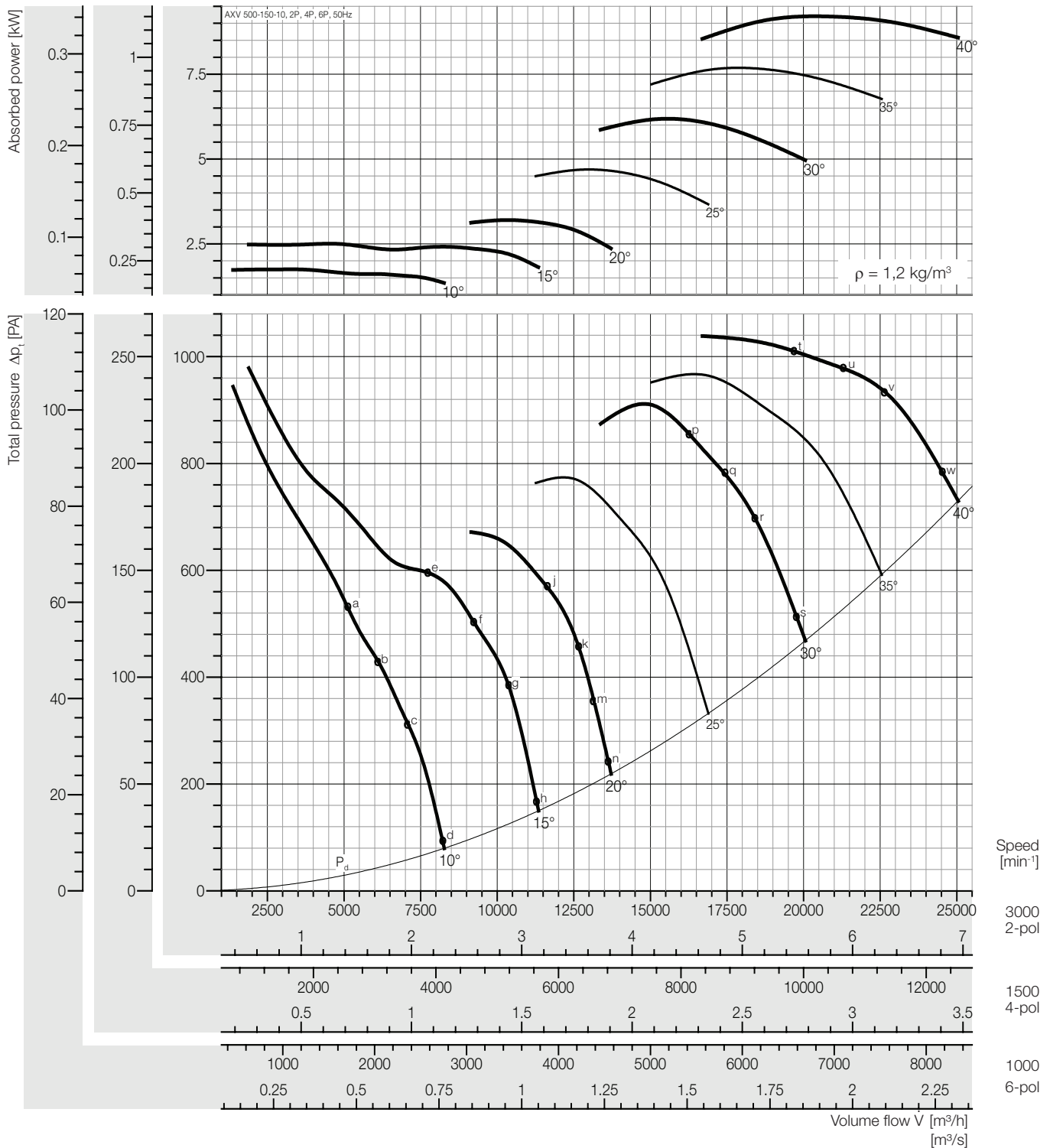

### Peak absorbed power [kW]

n [min <sup>-1</sup> ]	Pitch angle [°]						
	10	15	20	25	30	35	40
1000	0,115	0,168	0,230	0,322	0,413	0,501	0,597
Motor	0,25			0,37	0,55		0,75
1500	0,387	0,569	0,777	1,086	1,394	1,693	2,013
Motor	0,55	0,75	1,1		1,5	2,2	
3000	3,095	4,549	6,218	8,684	11,15	13,54	16,11
Motor	4,0	-					

### Sound power level, Lwi(A) [dB(A)]

Lwi(A)	a	b	c	d	e	f	g	h	j	k	m	n	p	q	r	s	t	u	v	w
2P	108	109	107	106	112	108	109	110	106	104	104	105	109	109	108	109	108	108	108	108
4P	89	91	91	89	95	90	91	93	88	87	87	88	93	93	91	92	91	90	91	91
6P	78	80	80	78	84	80	81	83	78	76	77	77	83	83	81	81	81	80	80	80

Plastic Duct

Lwi(A)	a	b	c	d	e	f	g	h	j	k	m	n	p	q	r	s	t	u	v	w
2P	106	107	105	104	110	106	107	108	104	102	102	103	107	107	106	107	106	106	106	106
4P	87	89	89	87	93	88	89	91	86	85	85	86	91	91	89	90	89	88	89	89
6P	76	78	78	76	82	78	79	81	76	74	75	75	81	81	79	79	79	78	78	78

\* Unlined Metal Duct

Fan test laboratory AMCA 210 Test Chamber. Performance certified is for installation type D - Ducted inlet, Ducted outlet. Performance ratings do not include the effects of appurtenances (accessories-belt cover, pulley & belt).

Dimensions + Accessories Page 191 - 194;  
Sound power frequency spectrum L<sub>w</sub> Page 196 - 200.

The A-weighted sound ratings shown have been calculated per AMCA International Standard 301. Values shown are for inlet LwiA sound power levels for installation Type D: ducted inlet, ducted outlet. Ratings include the effects of duct end correction.

\* Sound power level with unlined metal duct were obtained from the test in the reverberant room. Data are not licensed by AMCA.



# Performance Curve

AXV 560-200-9, 50 Hz

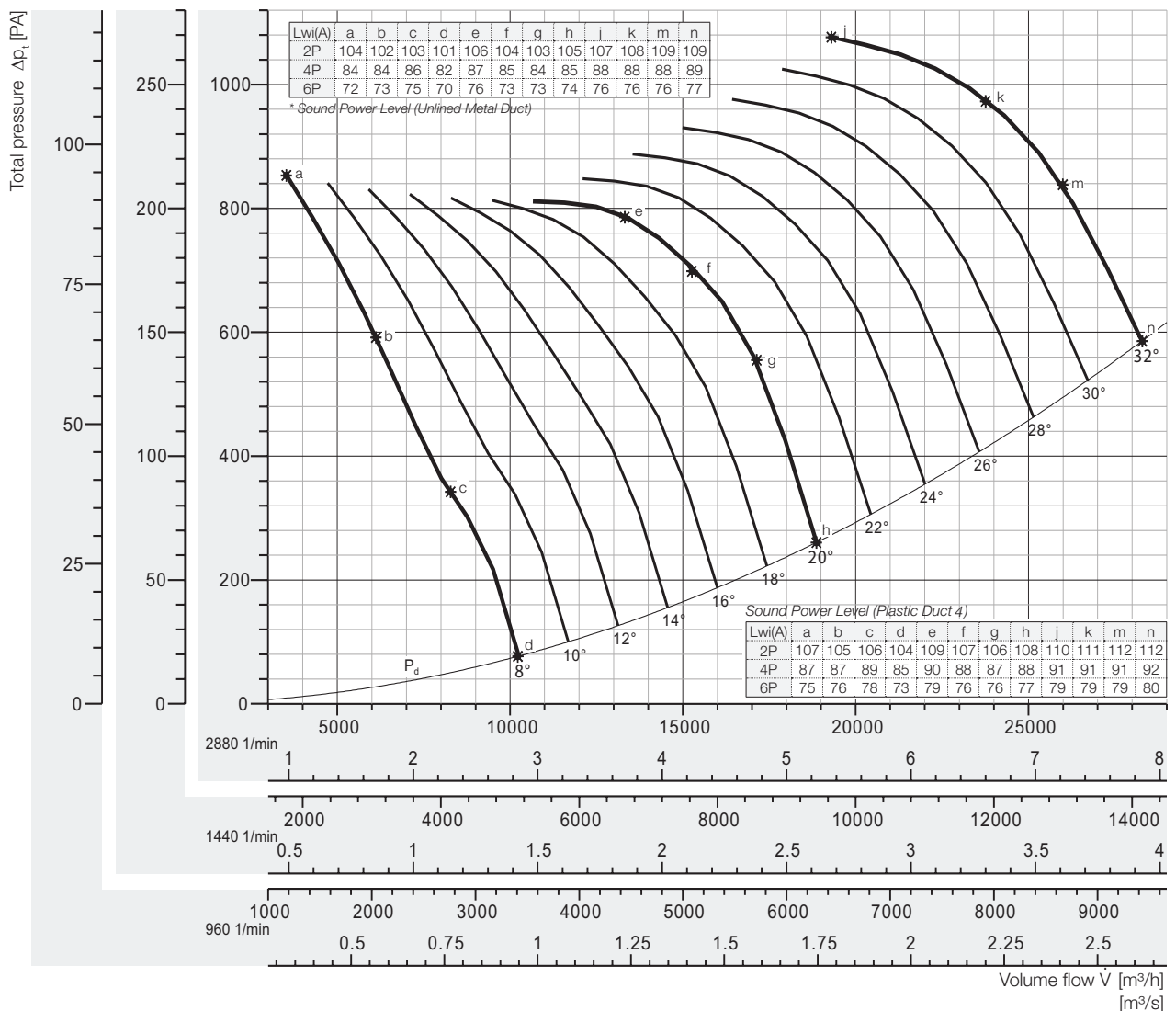
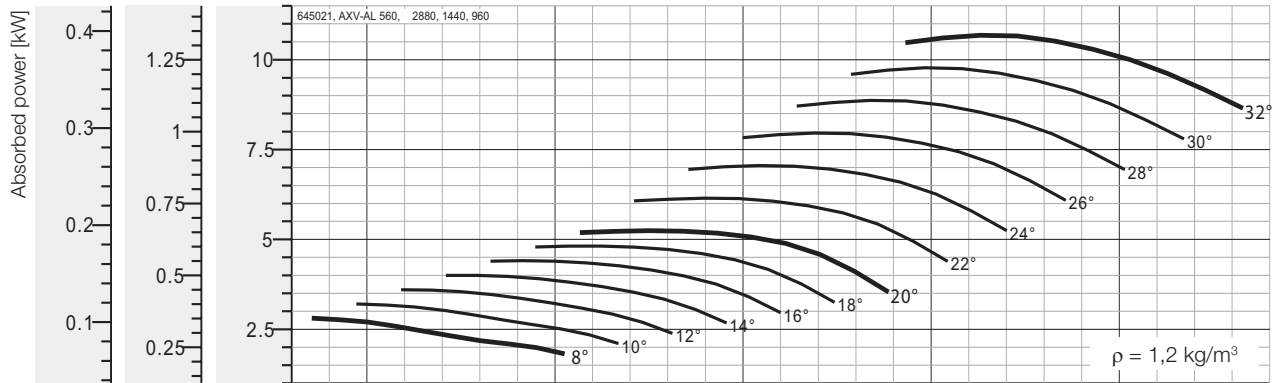

Speed [min<sup>-1</sup>]  
 2880 2-pol  
 1440 4-pol  
 960 6-pol

## Peak absorbed power [kW]

n [min <sup>-1</sup> ]	Pitch angle [°]																
	8	10	12	14	16	18	20	22	24	26	28	30	32	34	36	38	40
960 motor	0,104	0,119	0,133	0,148	0,163	0,178	0,194	0,228	0,261	0,295	0,329	0,362	0,396	-	-	-	-
	0,37												0,55				
1440 motor	0,351	0,401	0,450	0,500	0,551	0,602	0,655	0,769	0,882	0,995	1,11	1,22	1,34	-	-	-	-
	0,37	0,55			0,75			1,1			1,5						
2880 motor	2,81	3,21	3,60	4,01	4,41	4,82	5,24	6,15	7,06	7,96	8,87	9,78	10,7	-	-	-	-
	3	4			5,5			7,5		11							

Fan test laboratory AMCA 210 Test Chamber. Performance certified is for installation type D - Ducted inlet, Ducted outlet. Performance ratings do not include the effects of appurtenances (accessories-belt cover, pulley & belt).

Dimensions + Accessories Page 191 - 194;  
 Sound power frequency spectrum L<sub>w</sub> Page 196 - 200.

The A-weighted sound ratings shown have been calculated per AMCA International Standard 301. Values shown are for inlet Lw(A) sound power levels for installation Type D: ducted inlet, ducted outlet. Ratings include the effects of duct end correction.

\* Sound power level with unlined metal duct were obtained from the test in the reverberant room. Data are not licensed by AMCA.



# Performance Curve

AXV 560-250-7, 50 Hz

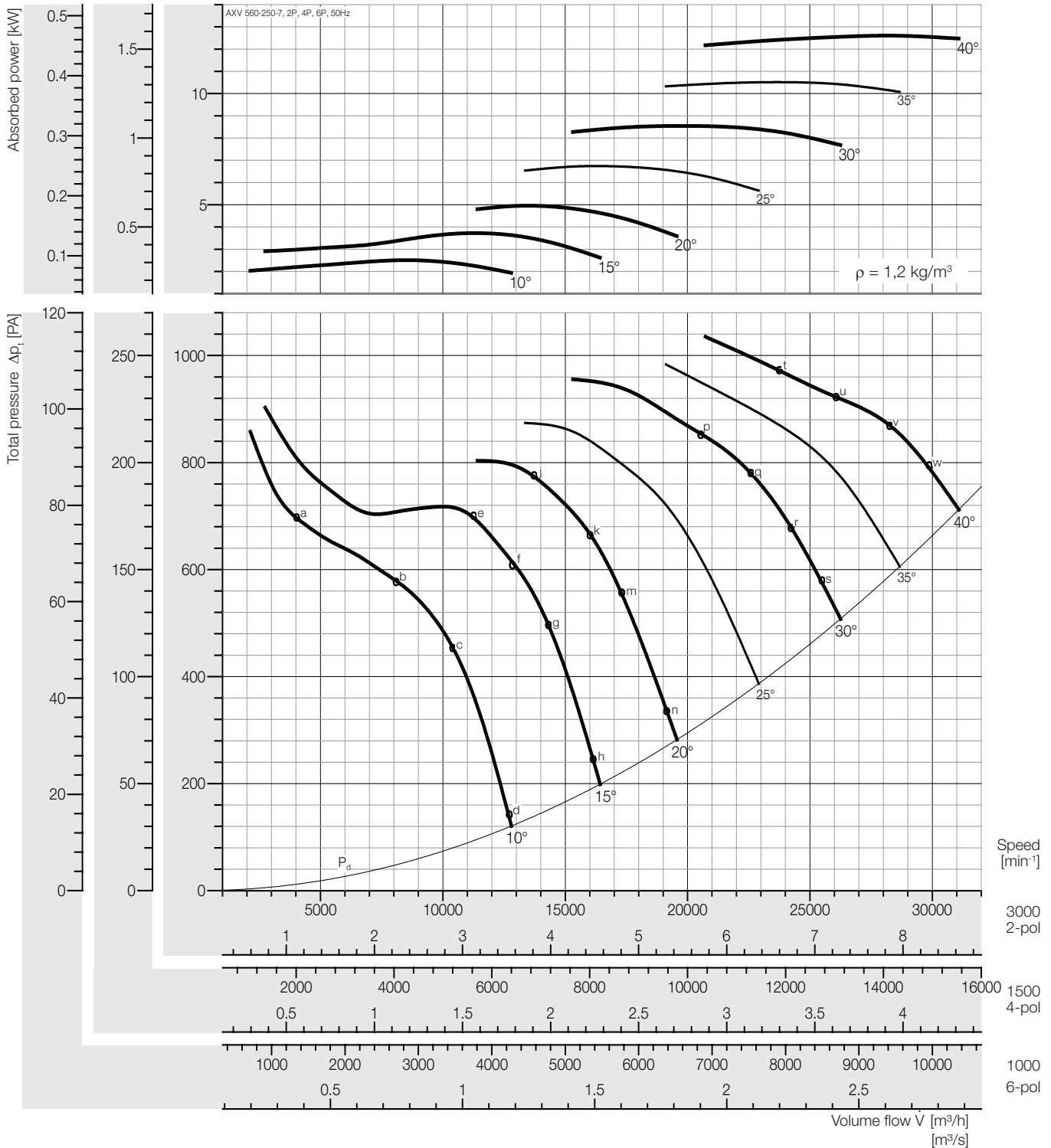

### Peak absorbed power [kW]

n [min <sup>-1</sup> ]	Pitch angle [°]						
	10	15	20	25	30	35	40
1000	0,093	0,137	0,183	0,250	0,316	0,389	0,467
Motor	0,37					0,55	
1500	0,312	0,464	0,619	0,842	1,068	1,314	1,575
Motor	0,37	0,55	0,75	1,1	1,5		2,2
3000	2,499	3,710	4,953	6,737	8,543	10,51	12,60
Motor	3,0	4,0	5,5	7,5	11	-	

### Sound power level, Lwi(A) [dB(A)]

Lwi(A)	a	b	c	d	e	f	g	h	j	k	m	n	p	q	r	s	t	u	v	w
2P	108	109	106	107	107	105	105	104	106	108	109	106	107	108	108	109	109	109	109	110
4P	89	91	89	90	89	86	86	87	88	89	87	89	89	89	90	91	91	91	91	92
6P	78	81	79	81	79	76	75	76	76	77	77	75	79	79	79	80	81	81	81	82

Plastic Duct

Lwi(A)	a	b	c	d	e	f	g	h	j	k	m	n	p	q	r	s	t	u	v	w
2P	106	107	104	105	105	103	103	102	104	106	107	104	105	106	106	107	107	107	107	108
4P	87	89	87	88	87	84	84	84	85	86	87	85	87	87	87	88	89	89	89	90
6P	76	79	77	79	77	74	73	74	74	75	75	73	77	77	77	78	79	79	79	80

\* Unlined Metal Duct

The A-weighted sound ratings shown have been calculated per AMCA International Standard 301. Values shown are for inlet LwiA sound power levels for installation Type D: ducted inlet, ducted outlet. Ratings include the effects of duct end correction.

\* Sound power level with unlined metal duct were obtained from the test in the reverberant room. Data are not licensed by AMCA.

Fan test laboratory AMCA 210 Test Chamber. Performance certified is for installation type D - Ducted inlet, Ducted outlet. Performance ratings do not include the effects of appurtenances (accessories-belt cover, pulley & belt).

Dimensions + Accessories Page 191 - 194;

Sound power frequency spectrum L<sub>w</sub>(A) Page 196 - 200.



# Performance Curve

AXV 560-250-14, 50 Hz

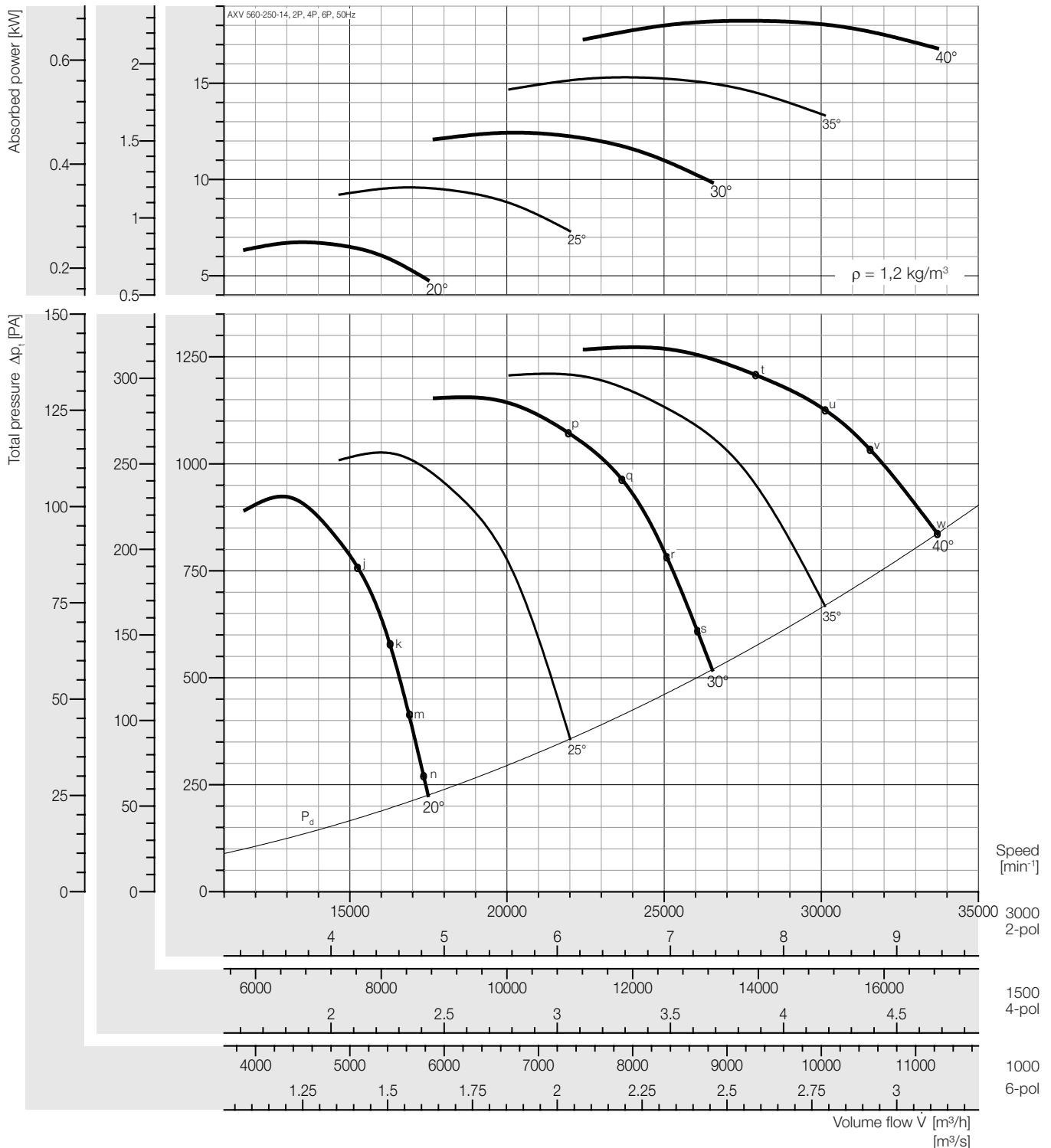

### Peak absorbed power [kW]

n [min <sup>-1</sup> ]	Pitch angle [°]						
	10	15	20	25	30	35	40
1000	-	-	0,250	0,355	0,460	0,567	0,676
Motor			0,37		0,55	0,75	
1500	-	-	0,842	1,198	1,553	1,913	2,280
Motor			1,1	1,5	2,2		3,0
3000	-	-	6,740	9,581	12,42	15,31	18,24
Motor			7,5	11	-		

### Sound power level, Lwi(A) [dB(A)]

Lwi(A)	a	b	c	d	e	f	g	h	j	k	m	n	p	q	r	s	t	u	v	w
2P	-	-	-	-	-	-	-	-	106	106	106	106	107	108	108	109	109	109	109	110
4P	-	-	-	-	-	-	-	-	88	88	89	90	90	91	91	92	91	92	92	93
6P	-	-	-	-	-	-	-	-	78	78	79	80	79	80	81	82	81	81	82	83

Plastic Duct

Lwi(A)	a	b	c	d	e	f	g	h	j	k	m	n	p	q	r	s	t	u	v	w
2P	-	-	-	-	-	-	-	-	104	104	104	104	105	106	106	107	107	107	107	108
4P	-	-	-	-	-	-	-	-	86	86	87	88	88	89	89	90	89	90	90	91
6P	-	-	-	-	-	-	-	-	76	76	77	78	77	78	79	80	79	79	80	81

\* Unlined Metal Duct

Fan test laboratory AMCA 210 Test Chamber. Performance certified is for installation type D - Ducted inlet, Ducted outlet. Performance ratings do not include the effects of appurtenances (accessories-belt cover, pulley & belt).

Dimensions + Accessories Page 191 - 194;  
Sound power frequency spectrum L<sub>wnd</sub> Page 196 - 200.

The A-weighted sound ratings shown have been calculated per AMCA International Standard 301. Values shown are for inlet Lwi(A) sound power levels for installation Type D: ducted inlet, ducted outlet. Ratings include the effects of duct end correction.

\* Sound power level with unlined metal duct were obtained from the test in the reverberant room. Data are not licensed by AMCA.



# Performance Curve

AXV 630-110-3, 50 Hz

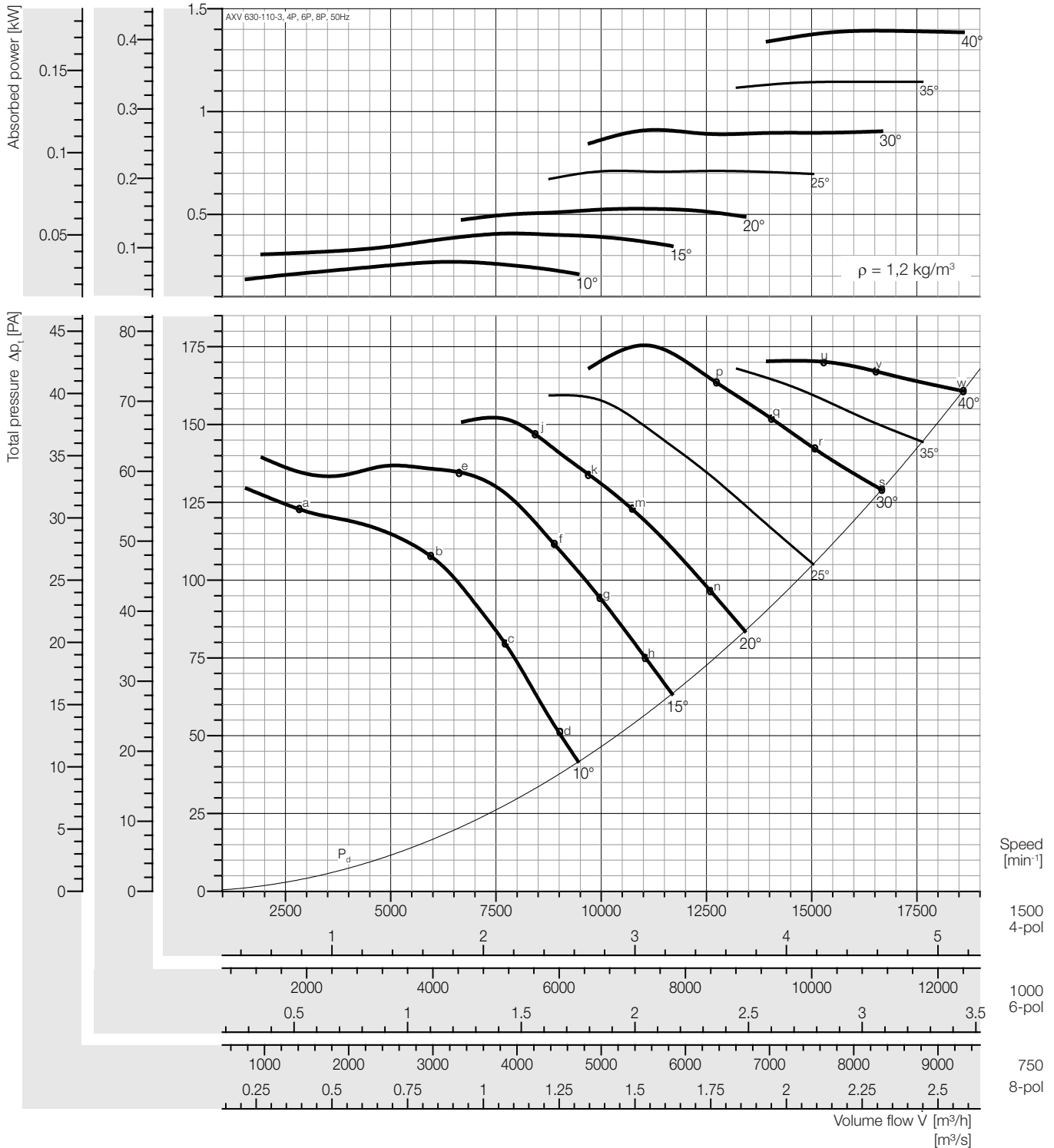

### Peak absorbed power [kW]

n [min <sup>-1</sup> ]	Pitch angle [°]						
	10	15	20	25	30	35	40
750	0,033	0,051	0,066	0,089	0,114	0,143	0,174
Motor	0,37						
1000	0,079	0,120	0,156	0,211	0,270	0,339	0,413
Motor	0,37						0,55
1500	0,268	0,404	0,527	0,711	0,911	1,145	1,393
Motor	0,37	0,55		0,75	1,1	1,5	

### Sound power level, Lwi(A) [dB(A)]

Lwi(A)	a	b	c	d	e	f	g	h	j	k	m	n	p	q	r	s	t	u	v	w
4P	92	90	88	89	90	88	87	87	88	88	88	88	89	89	89	89	-	92	91	92
6P	81	80	78	79	78	77	77	76	78	78	78	78	79	78	78	78	-	81	81	81
8P	74	73	71	72	70	70	69	69	70	70	70	70	71	71	71	71	-	74	73	74

Plastic Duct

Lwi(A)	a	b	c	d	e	f	g	h	j	k	m	n	p	q	r	s	t	u	v	w
4P	90	88	86	87	88	86	85	85	86	86	86	86	87	87	87	87	-	90	89	90
6P	79	78	76	77	76	75	75	74	76	76	76	76	77	76	76	76	-	79	79	79
8P	72	71	69	70	68	68	67	67	68	68	68	68	69	69	69	69	-	72	71	72

\* Unlined Metal Duct

Fan test laboratory AMCA 210 Test Chamber. Performance certified is for installation type D - Ducted inlet, Ducted outlet. Performance ratings do not include the effects of appurtenances (accessories-belt cover, pulley & belt).

Dimensions + Accessories Page 191 - 194;  
Sound power frequency spectrum L<sub>w</sub> Page 196 - 200.

The A-weighted sound ratings shown have been calculated per AMCA International Standard 301. Values shown are for inlet LwiA sound power levels for installation Type D: ducted inlet, ducted outlet. Ratings include the effects of duct end correction.

\* Sound power level with unlined metal duct were obtained from the test in the reverberant room. Data are not licensed by AMCA.



# Performance Curve

AXV 630-110-6, 50 Hz

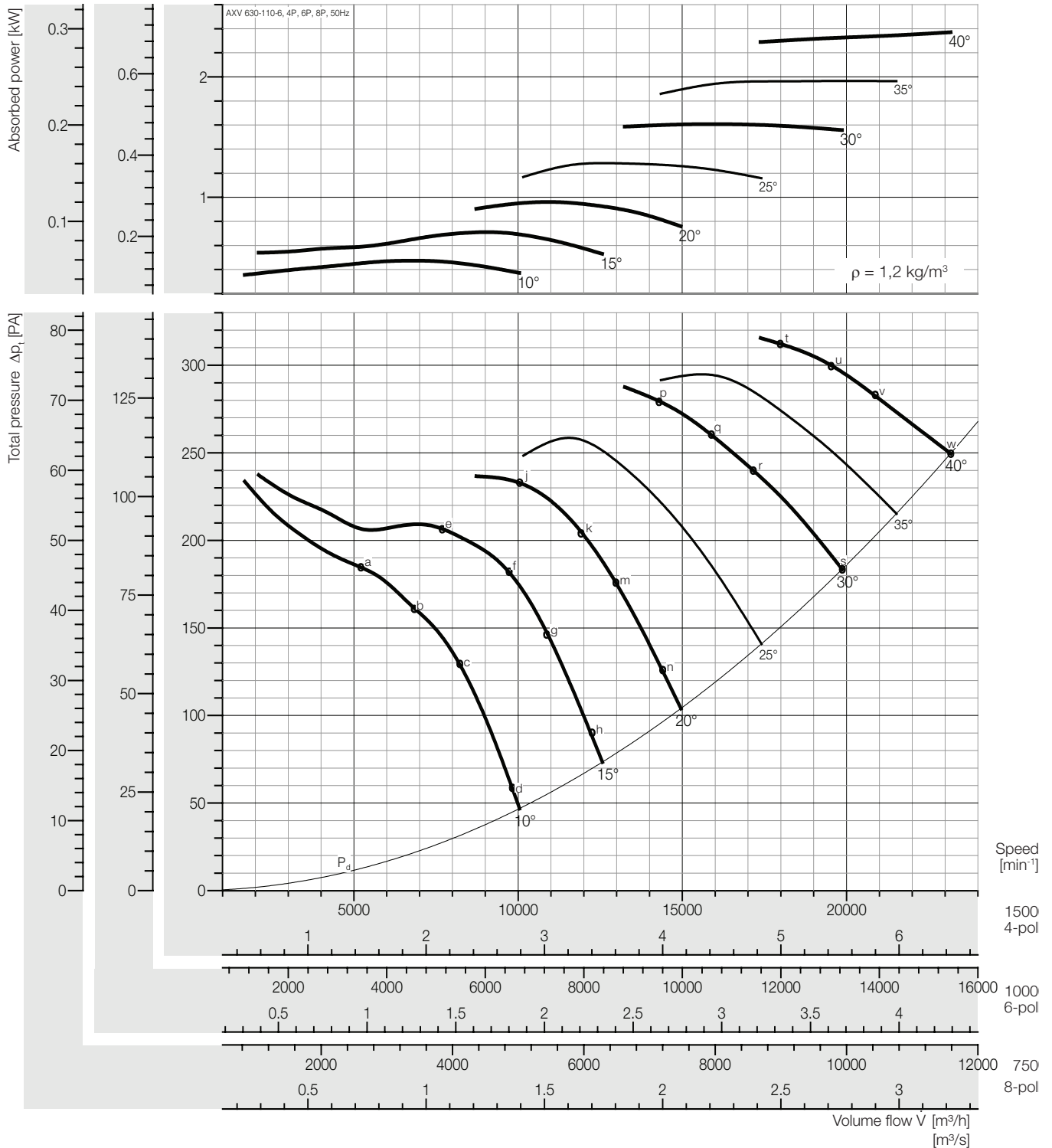

## Peak absorbed power [kW]

n [min <sup>-1</sup> ]	Pitch angle [°]						
	10	15	20	25	30	35	40
750	0,059	0,089	0,120	0,160	0,201	0,246	0,296
Motor	0,37						
1000	0,140	0,211	0,285	0,380	0,476	0,583	0,702
Motor	0,37		0,55		0,75		
1500	0,472	0,711	0,961	1,284	1,607	1,966	2,371
Motor	0,55	0,75	1,1	1,5	2,2	3,0	

## Sound power level, Lwi(A) [dB(A)]

Lwi(A)	a	b	c	d	e	f	g	h	j	k	m	n	p	q	r	s	t	u	v	w
4P	93	93	90	89	94	91	90	90	91	90	90	90	93	92	92	92	93	93	93	93
6P	82	83	80	79	84	81	80	80	81	80	80	83	82	82	82	83	83	83	83	83
8P	74	75	73	72	76	73	72	72	72	71	72	72	75	74	74	74	75	75	75	75

Plastic Duct

Lwi(A)	a	b	c	d	e	f	g	h	j	k	m	n	p	q	r	s	t	u	v	w
4P	91	91	88	87	92	89	88	88	89	88	88	88	91	90	90	90	91	91	91	91
6P	80	81	78	77	82	79	78	78	79	78	78	81	80	80	80	81	81	81	81	81
8P	72	73	71	70	74	71	70	70	70	69	70	70	73	72	72	72	73	73	73	73

\* Unlined Metal Duct

Fan test laboratory AMCA 210 Test Chamber. Performance certified is for installation type D - Ducted inlet, Ducted outlet. Performance ratings do not include the effects of appurtenances (accessories-belt cover, pulley & belt).

Dimensions + Accessories Page 191 - 194;  
Sound power frequency spectrum L<sub>w</sub> Page 196 - 200.

The A-weighted sound ratings shown have been calculated per AMCA International Standard 301. Values shown are for inlet LwiA sound power levels for installation Type D: ducted inlet, ducted outlet. Ratings include the effects of duct end correction.

\* Sound power level with unlined metal duct were obtained from the test in the reverberant room. Data are not licensed by AMCA.





# Performance Curve

AXV 630-150-5, 50 Hz

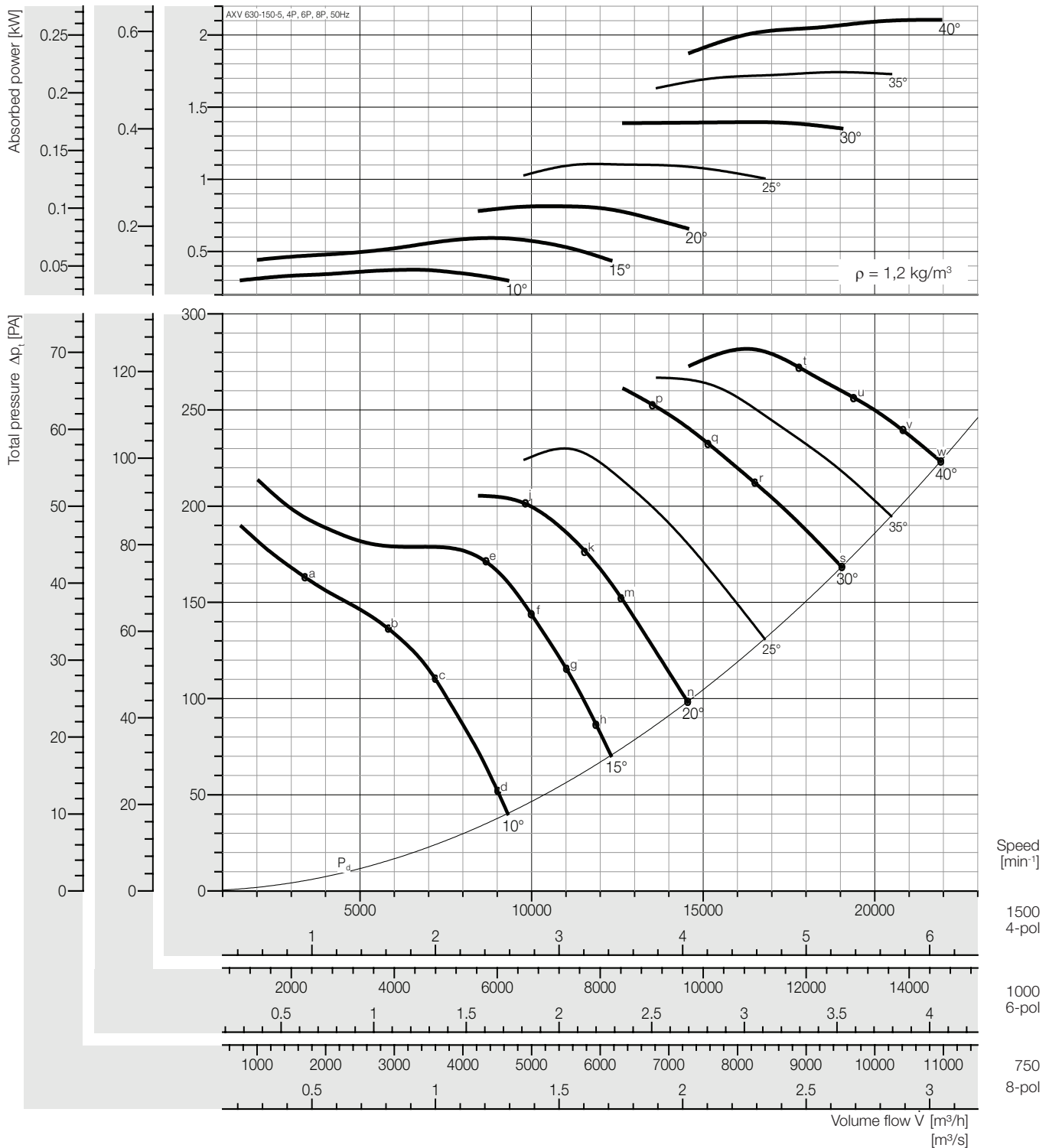

### Peak absorbed power [kW]

n [min <sup>-1</sup> ]	Pitch angle [°]							
	10	15	20	25	30	35	40	
750	0,047	0,074	0,102	0,138	0,175	0,218	0,263	
Motor	0,37							
1000	0,111	0,176	0,241	0,328	0,414	0,516	0,624	
Motor	0,37						0,55	0,75
1500	0,373	0,594	0,814	1,106	1,396	1,743	2,106	
Motor	0,55	0,75	1,1	1,5	2,2			

### Sound power level, Lwi(A) [dB(A)]

Lwi(A)	a	b	c	d	e	f	g	h	j	k	m	n	p	q	r	s	t	u	v	w
4P	90	92	90	88	93	95	90	92	91	90	90	91	92	92	92	93	94	94	95	95
6P	78	81	80	78	82	85	79	82	80	79	79	80	81	80	80	81	83	83	83	84
8P	70	74	73	70	75	78	72	75	73	72	72	72	73	73	73	73	75	75	76	76

Plastic Duct

Lwi(A)	a	b	c	d	e	f	g	h	j	k	m	n	p	q	r	s	t	u	v	w
4P	88	90	88	86	91	93	88	90	89	88	88	89	90	90	90	91	92	92	93	93
6P	76	79	78	76	80	83	77	80	78	77	77	78	79	78	78	79	81	81	81	82
8P	68	72	71	68	73	76	70	73	71	70	70	70	71	71	71	71	73	73	74	74

\* Unlined Metal Duct

Fan test laboratory AMCA 210 Test Chamber. Performance certified is for installation type D - Ducted inlet, Ducted outlet. Performance ratings do not include the effects of appurtenances (accessories-belt cover, pulley & belt).

Dimensions + Accessories Page 191 - 194;

Sound power frequency spectrum L<sub>w</sub> Page 196 - 200.

The A-weighted sound ratings shown have been calculated per AMCA International Standard 301. Values shown are for inlet LwiA sound power levels for installation Type D: ducted inlet, ducted outlet. Ratings include the effects of duct end correction.

\* Sound power level with unlined metal duct were obtained from the test in the reverberant room. Data are not licensed by AMCA.



# Performance Curve

AXV 630-150-10, 50 Hz

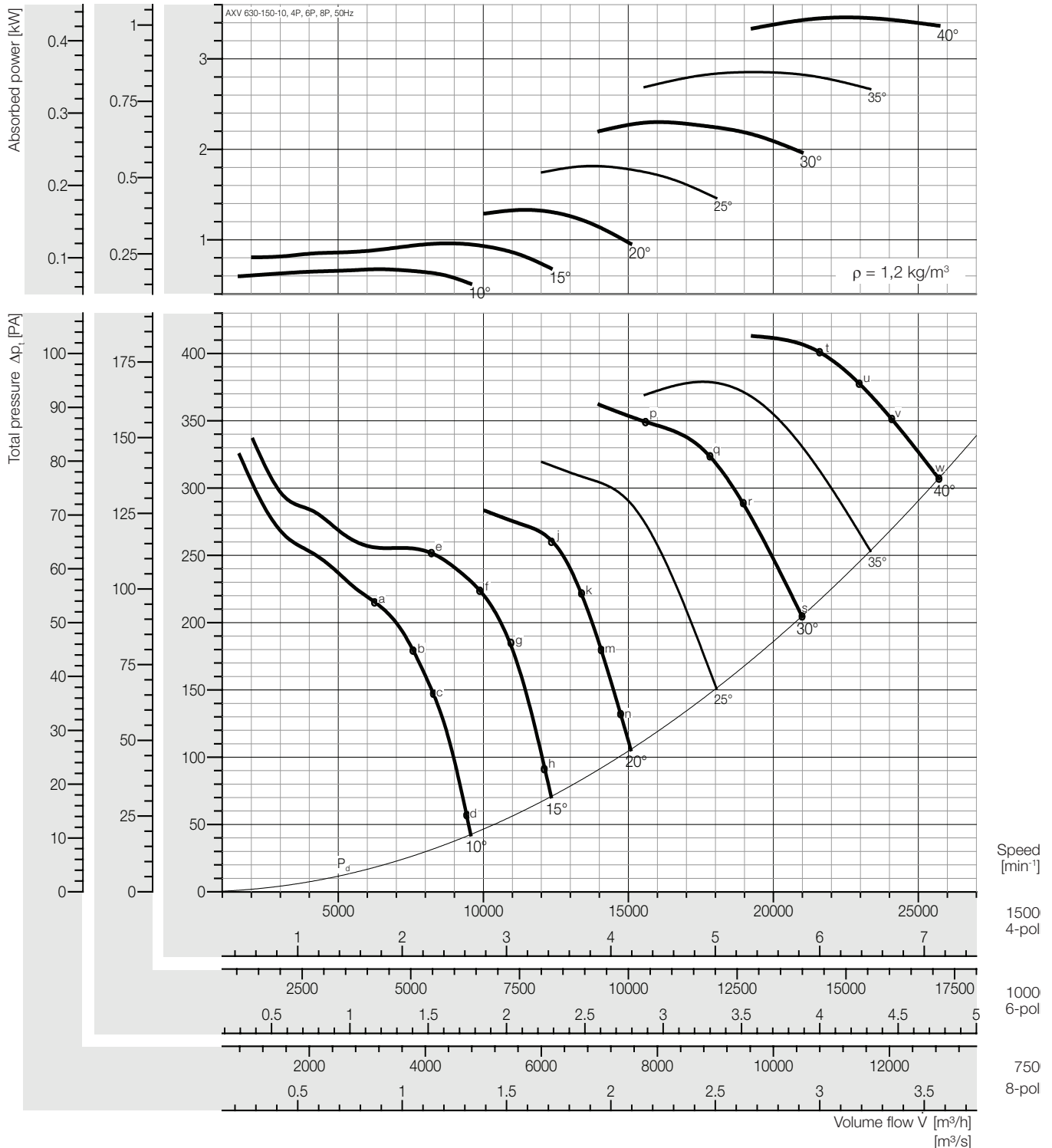

### Peak absorbed power [kW]

n [min <sup>-1</sup> ]	Pitch angle [°]								
	10	15	20	25	30	35	40		
750	0,084	0,120	0,166	0,232	0,311	0,371	0,432		
Motor	0,37					0,55			
1000	0,199	0,284	0,394	0,549	0,736	0,880	1,024		
Motor	0,37		0,55		0,75		1,1		
1500	0,672	0,960	1,328	1,852	2,486	2,971	3,458		
Motor	0,75		1,1		1,5		2,2	3,0	4,0

### Sound power level, Lwi(A) [dB(A)]

Lwi(A)	a	b	c	d	e	f	g	h	j	k	m	n	p	q	r	s	t	u	v	w
4P	95	93	92	91	96	93	91	92	92	92	92	93	93	94	94	94	94	94	94	95
6P	84	83	82	82	85	83	81	82	82	81	82	83	82	82	83	83	83	83	83	84
8P	76	76	75	75	77	75	73	74	74	74	74	75	75	75	75	76	76	76	76	77

Plastic Duct

Lwi(A)	a	b	c	d	e	f	g	h	j	k	m	n	p	q	r	s	t	u	v	w
4P	93	91	90	89	94	91	89	90	90	90	90	91	91	92	92	92	92	92	92	93
6P	82	81	80	80	83	81	79	80	80	79	80	81	80	80	81	81	81	81	81	82
8P	74	74	73	73	75	73	71	72	72	72	72	73	73	73	73	74	74	74	74	75

\* Unlined Metal Duct

Fan test laboratory AMCA 210 Test Chamber. Performance certified is for installation type D - Ducted inlet, Ducted outlet. Performance ratings do not include the effects of appurtenances (accessories-belt cover, pulley & belt).

Dimensions + Accessories Page 191 - 194;  
Sound power frequency spectrum L<sub>wnd</sub> Page 196 - 200.

The A-weighted sound ratings shown have been calculated per AMCA International Standard 301. Values shown are for inlet Lwi(A) sound power levels for installation Type D: ducted inlet, ducted outlet. Ratings include the effects of duct end correction.

\* Sound power level with unlined metal duct were obtained from the test in the reverberant room. Data are not licensed by AMCA.



# Performance Curve

AXV 630-200-9, 50 Hz

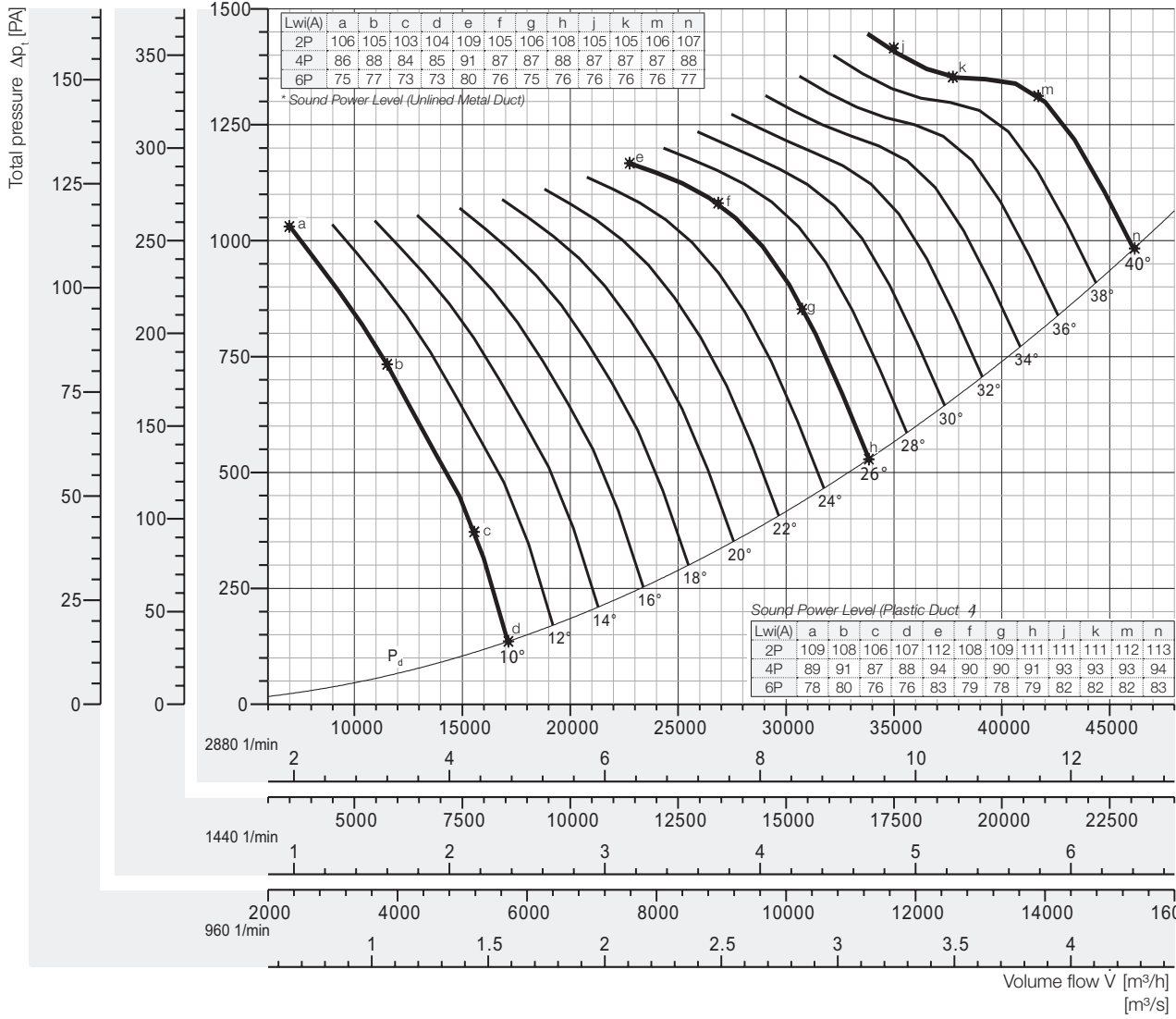
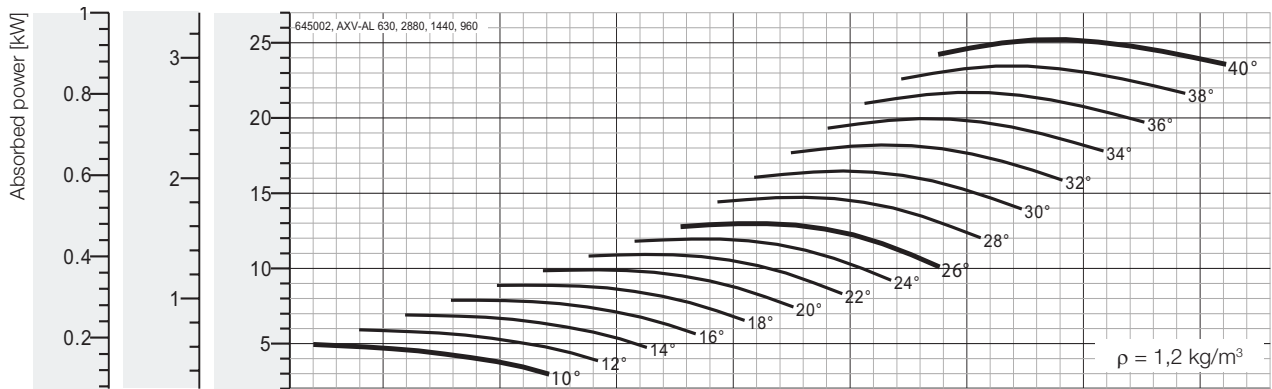

## Peak absorbed power [kW]

\* Out of Range

n [min <sup>-1</sup> ]	Pitch angle [°]																
	8	10	12	14	16	18	20	22	24	26	28	30	32	34	36	38	40
960 motor	-	0,183	0,219	0,256	0,292	0,329	0,367	0,405	0,443	0,481	0,545	0,610	0,675	0,739	0,804	0,868	0,934
		0,37						0,55				0,75			1,1		
1440 motor	-	0,618	0,741	0,863	0,986	1,11	1,24	1,37	1,49	1,62	1,84	2,06	2,28	2,50	2,71	2,93	3,15
		0,75		1,1		1,5			2,2			3			4		
2880 motor	-	4,94	5,92	6,90	7,88	8,88	9,90	10,9	12,0	13,0	14,7	16,5	18,2	20,0	21,7	23,4	25,2
		5,5	7,5		11				15			18,5		-*			

Fan test laboratory AMCA 210 Test Chamber. Performance certified is for installation type D - Ducted inlet, Ducted outlet. Performance ratings do not include the effects of appurtenances (accessories-belt cover, pulley & belt).

Dimensions + Accessories Page 191 ~ 194;  
Sound power frequency spectrum L<sub>w</sub> Page 196 ~ 200.

The A-weighted sound ratings shown have been calculated per AMCA International Standard 301. Values shown are for inlet LwA sound power levels for installation Type D: ducted inlet, ducted outlet. Ratings include the effects of duct end correction.

\* Sound power level with unlined metal duct were obtained from the test in the reverberant room. Data are not licensed by AMCA.



# Performance Curve

AXV 630-250-7, 50 Hz

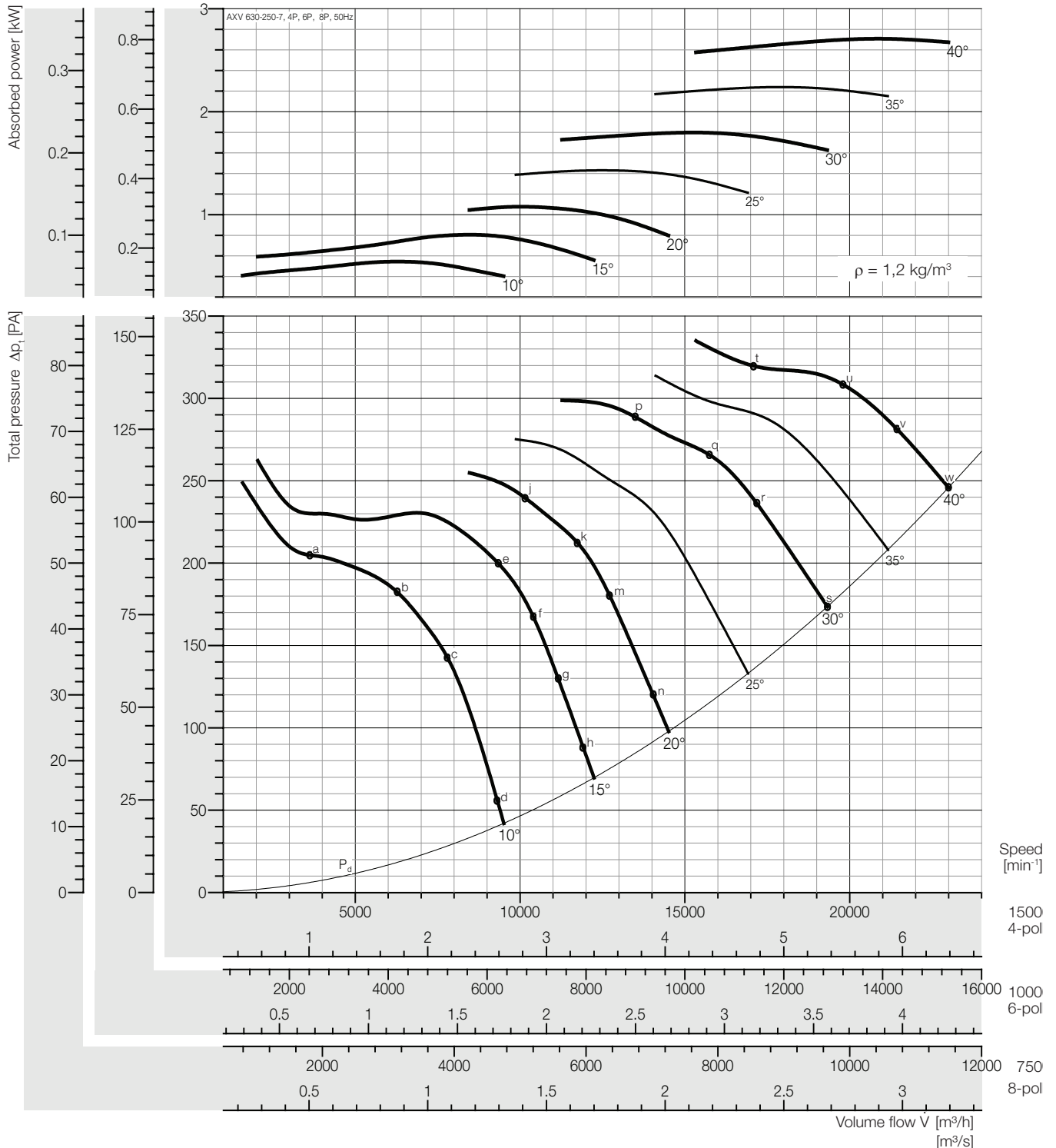

### Peak absorbed power [kW]

n [min <sup>-1</sup> ]	Pitch angle [°]									
	10	15	20	25	30	35	40			
750	0,068	0,100	0,135	0,179	0,225	0,280	0,338			
Motor	0,37									
1000	0,161	0,238	0,319	0,424	0,532	0,663	0,802			
Motor	0,37						0,55	0,75	1,1	
1500	0,543	0,803	1,077	1,430	1,796	2,239	2,707			
Motor	0,55						1,1	1,5	2,2	3,0

### Sound power level, Lwi(A) [dB(A)]

Lwi(A)	a	b	c	d	e	f	g	h	j	k	m	n	p	q	r	s	t	u	v	w
4P	94	94	91	91	90	90	90	91	90	90	90	91	92	92	92	92	94	94	94	95
6P	84	85	83	82	80	80	80	81	80	80	80	81	82	81	81	82	84	84	84	84
8P	77	78	76	75	73	72	73	73	73	73	73	74	75	74	74	74	77	76	76	77

Plastic Duct

Lwi(A)	a	b	c	d	e	f	g	h	j	k	m	n	p	q	r	s	t	u	v	w
4P	92	91	89	89	88	88	88	89	88	88	88	89	90	90	90	90	92	92	92	93
6P	82	83	81	80	78	78	78	79	78	78	78	79	80	79	79	80	82	82	82	82
8P	75	76	74	73	71	70	71	71	71	71	71	72	73	72	72	72	75	74	74	75

\* Unlined Metal Duct

Fan test laboratory AMCA 210 Test Chamber. Performance certified is for installation type D - Ducted inlet, Ducted outlet. Performance ratings do not include the effects of appurtenances (accessories-belt cover, pulley & belt).

Dimensions + Accessories Page 191 - 194;  
Sound power frequency spectrum L<sub>wnd</sub> Page 196 - 200.

The A-weighted sound ratings shown have been calculated per AMCA International Standard 301. Values shown are for inlet LwiA sound power levels for installation Type D: ducted inlet, ducted outlet. Ratings include the effects of duct end correction.

\* Sound power level with unlined metal duct were obtained from the test in the reverberant room. Data are not licensed by AMCA.



# Performance Curve

AXV 630-250-14, 50 Hz

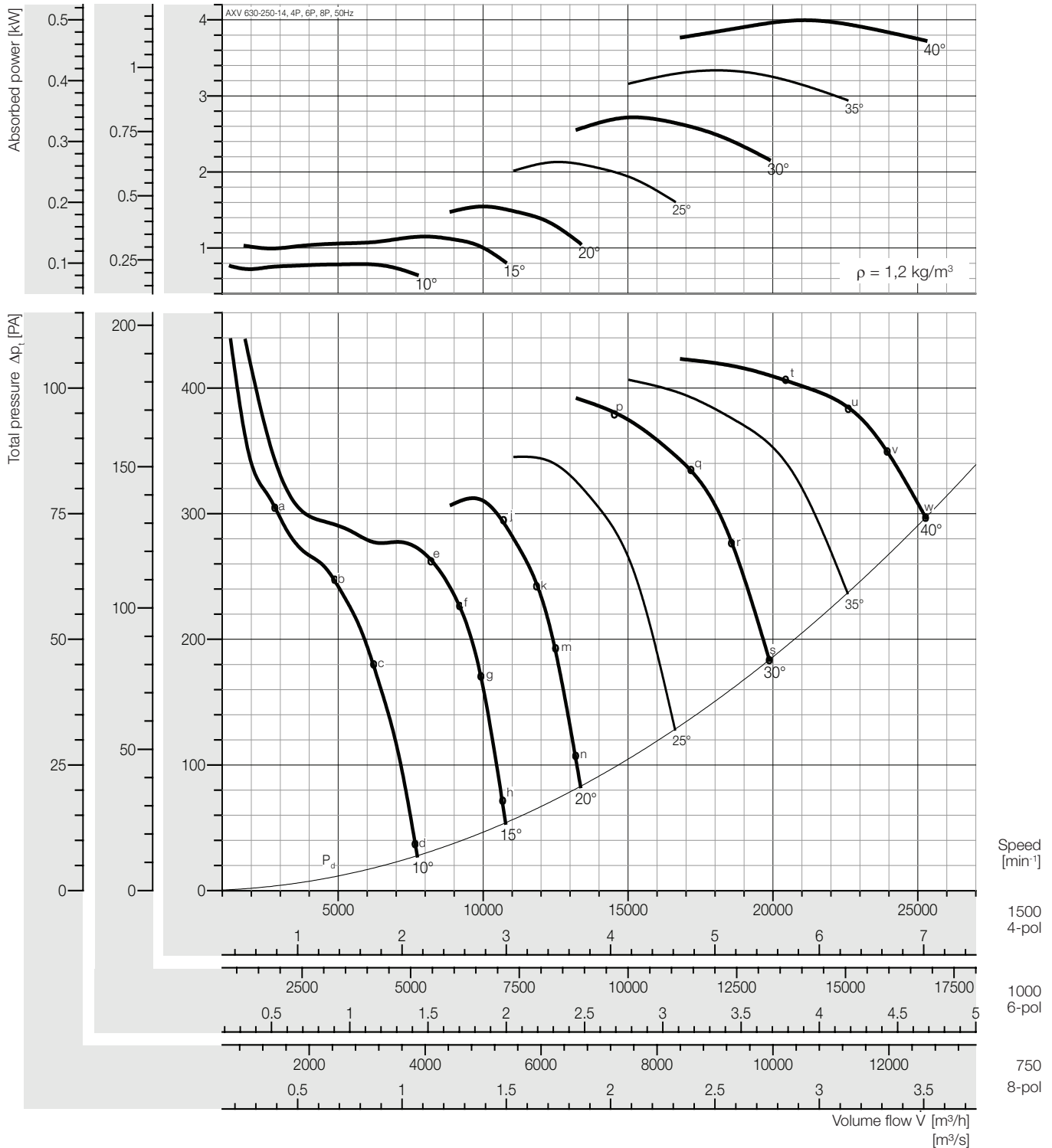

### Peak absorbed power [kW]

n [min <sup>-1</sup> ]	Pitch angle [°]						
	10	15	20	25	30	35	40
750	0,099	0,144	0,193	0,266	0,339	0,417	0,499
Motor	0,37					0,55	
1000	0,234	0,340	0,458	0,630	0,804	0,988	1,182
Motor	0,37		0,55	0,75	1,1	1,5	
1500	0,788	1,149	1,545	2,126	2,715	3,333	3,990
Motor	1,1	1,5	2,2	3,0		4,0	

### Sound power level, Lwi(A) [dB(A)]

Lwi(A)	a	b	c	d	e	f	g	h	j	k	m	n	p	q	r	s	t	u	v	w
4P	92	94	95	94	95	93	92	93	93	93	93	94	94	94	95	95	95	96	96	97
6P	82	84	85	84	85	83	82	84	84	83	83	84	84	84	85	85	85	85	86	87
8P	74	76	78	77	77	76	75	76	76	76	75	77	77	77	77	78	78	77	78	79

Plastic Duct

Lwi(A)	a	b	c	d	e	f	g	h	j	k	m	n	p	q	r	s	t	u	v	w
4P	90	92	93	92	93	91	90	91	91	91	91	92	92	92	93	93	93	94	94	95
6P	80	82	83	82	83	81	80	82	82	81	81	82	82	82	83	83	83	83	84	85
8P	72	74	76	75	75	74	73	74	74	74	73	75	75	75	75	76	76	75	76	77

\* Unlined Metal Duct

The A-weighted sound ratings shown have been calculated per AMCA International Standard 301. Values shown are for inlet LwiA sound power levels for installation Type D: ducted inlet, ducted outlet. Ratings include the effects of duct end correction.

\* Sound power level with unlined metal duct were obtained from the test in the reverberant room. Data are not licensed by AMCA.

Fan test laboratory AMCA 210 Test Chamber. Performance certified is for installation type D - Ducted inlet, Ducted outlet. Performance ratings do not include the effects of appurtenances (accessories-belt cover, pulley & belt).

Dimensions + Accessories Page 191 - 194;

Sound power frequency spectrum L<sub>w</sub> Page 196 - 200.



# Performance Curve

AXV 710-110-3, 50 Hz

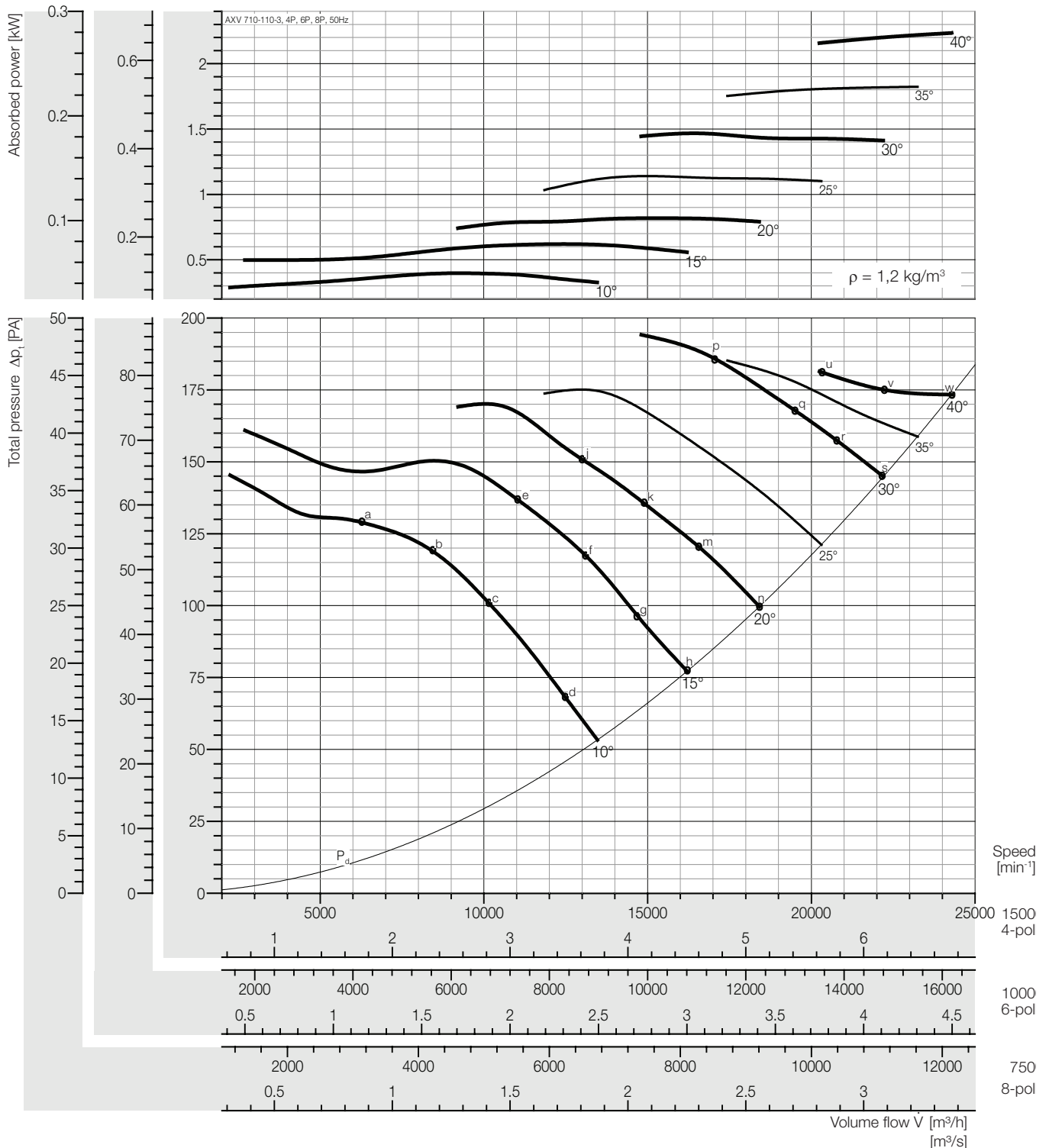

### Peak absorbed power [kW]

n [min <sup>-1</sup> ]	Pitch angle [°]							
	10	15	20	25	30	35	40	
750	0,050	0,077	0,102	0,142	0,183	0,228	0,279	
Motor	0,37							
1000	0,117	0,183	0,242	0,338	0,435	0,540	0,662	
Motor	0,37						0,55	0,75
1500	0,396	0,619	0,818	1,139	1,467	1,823	2,235	
Motor	0,55	0,75	1,1	1,5	2,2		3,0	

### Sound power level, Lwi(A) [dB(A)]

Lwi(A)	a	b	c	d	e	f	g	h	j	k	m	n	p	q	r	s	t	u	v	w
4P	94	92	89	85	89	88	87	88	88	88	88	92	92	92	92	93	-	96	94	94
6P	83	82	78	75	79	78	78	78	78	78	78	82	82	82	82	82	-	85	84	83
8P	75	74	71	68	72	71	71	71	71	71	71	75	75	75	75	75	-	77	76	76

Plastic Duct

Lwi(A)	a	b	c	d	e	f	g	h	j	k	m	n	p	q	r	s	t	u	v	w
4P	92	90	87	83	89	86	85	86	86	86	86	90	90	90	90	91	-	94	92	92
6P	81	80	76	73	77	76	76	76	76	76	76	80	80	80	80	80	-	83	82	81
8P	73	72	69	66	70	69	69	69	69	69	69	73	73	73	73	73	-	75	74	74

\* Unlined Metal Duct

Fan test laboratory AMCA 210 Test Chamber. Performance certified is for installation type D - Ducted inlet, Ducted outlet. Performance ratings do not include the effects of appurtenances (accessories-belt cover, pulley & belt).

Dimensions + Accessories Page 191 - 194;  
Sound power frequency spectrum L<sub>w</sub> Page 196 - 200.

The A-weighted sound ratings shown have been calculated per AMCA International Standard 301. Values shown are for inlet LwiA sound power levels for installation Type D: ducted inlet, ducted outlet. Ratings include the effects of duct end correction.

\* Sound power level with unlined metal duct were obtained from the test in the reverberant room. Data are not licensed by AMCA.



# Performance Curve

AXV 710-110-6, 50 Hz

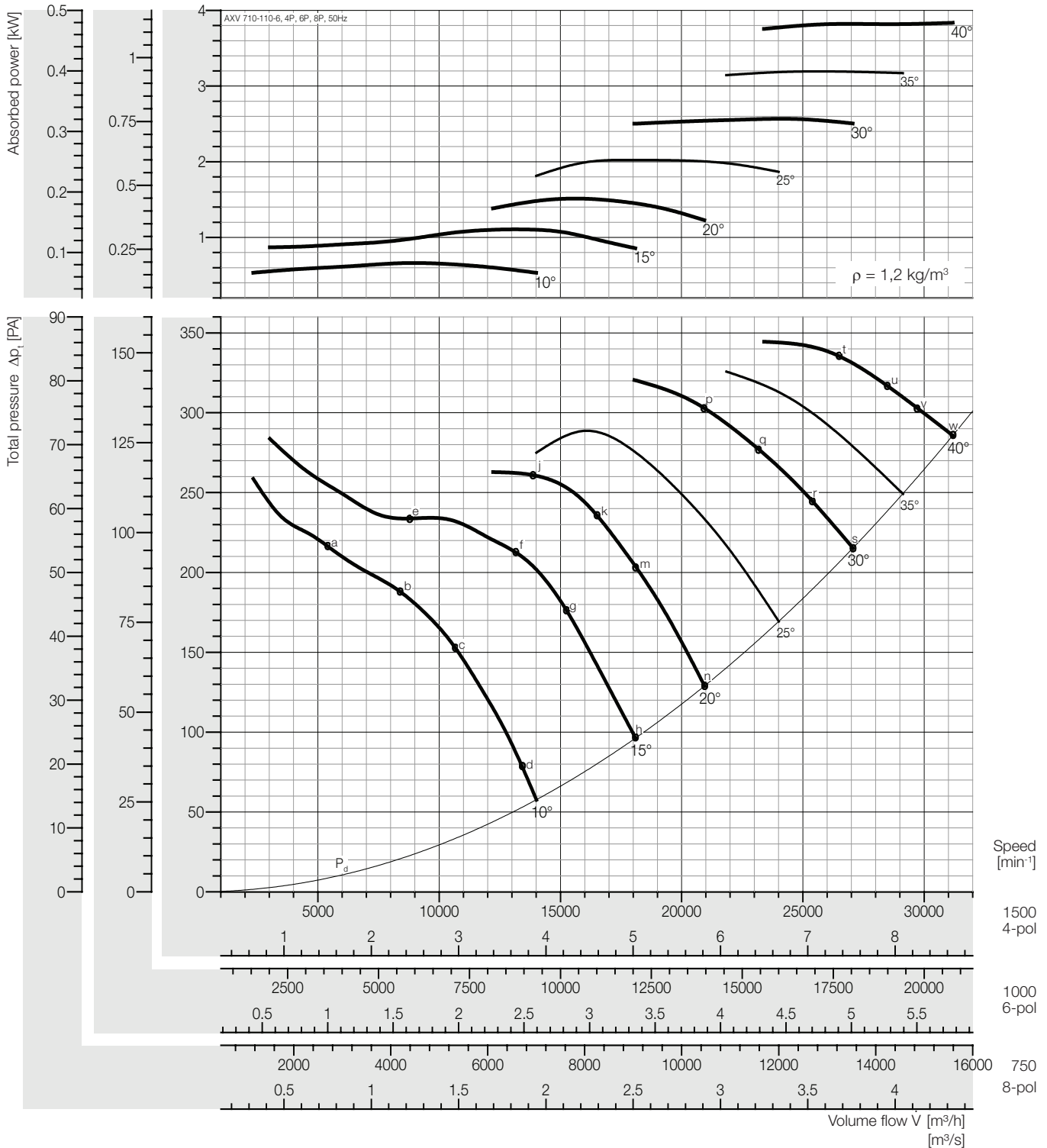

### Peak absorbed power [kW]

n [min <sup>-1</sup> ]	Pitch angle [°]						
	10	15	20	25	30	35	40
750	0,083	0,138	0,189	0,253	0,321	0,399	0,480
Motor	0,37					0,55	
1000	0,196	0,328	0,448	0,599	0,761	0,946	1,137
Motor	0,37		0,55	0,75	1,1	1,5	
1500	0,662	1,106	1,510	2,023	2,567	3,194	3,836
Motor	0,75	1,5	2,2	3,0		4,0	

### Sound power level, Lwi(A) [dB(A)]

Lwi(A)	a	b	c	d	e	f	g	h	j	k	m	n	p	q	r	s	t	u	v	w
4P	93	96	96	89	100	95	91	91	97	95	95	97	96	96	96	95	98	98	98	99
6P	83	85	86	80	89	85	81	81	85	83	82	83	85	85	85	84	88	87	87	88
8P	74	78	78	73	81	77	74	74	78	76	75	76	77	77	77	77	80	80	80	80

Plastic Duct

Lwi(A)	a	b	c	d	e	f	g	h	j	k	m	n	p	q	r	s	t	u	v	w
4P	91	94	94	87	98	83	89	89	95	93	93	95	94	94	94	93	96	96	96	97
6P	81	83	84	78	87	83	79	79	83	81	80	81	83	83	83	82	86	85	85	86
8P	72	76	76	71	79	75	72	72	76	74	73	74	75	75	75	75	78	78	78	78

\* Unlined Metal Duct

The A-weighted sound ratings shown have been calculated per AMCA International Standard 301. Values shown are for inlet LwiA sound power levels for installation Type D: ducted inlet, ducted outlet. Ratings include the effects of duct end correction.

\* Sound power level with unlined metal duct were obtained from the test in the reverberant room. Data are not licensed by AMCA.

Fan test laboratory AMCA 210 Test Chamber. Performance certified is for installation type D - Ducted inlet, Ducted outlet. Performance ratings do not include the effects of appurtenances (accessories-belt cover, pulley & belt).

Dimensions + Accessories Page 191 - 194;

Sound power frequency spectrum L<sub>w</sub> Page 196 - 200.



# Performance Curve

AXV 710-150-5, 50 Hz

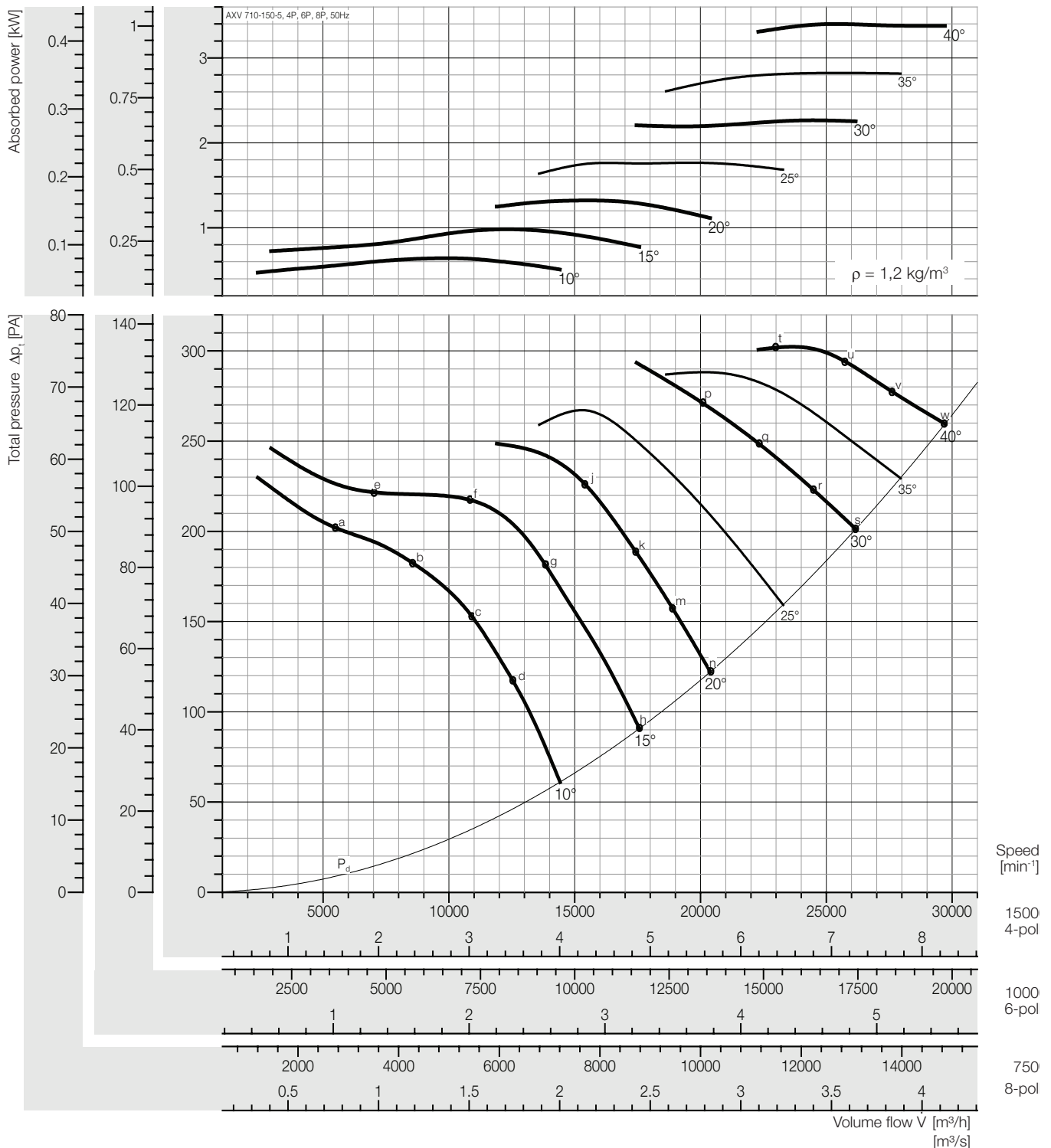

## Peak absorbed power [kW]

n [min <sup>-1</sup> ]	Pitch angle [°]						
	10	15	20	25	30	35	40
750	0,080	0,123	0,165	0,221	0,283	0,353	0,425
Motor	0,37						0,55
1000	0,190	0,291	0,392	0,523	0,671	0,837	1,007
Motor	0,37		0,55	0,75	1,1		
1500	0,640	0,981	1,322	1,765	2,265	2,824	3,399
Motor	0,75	1,1	1,5	2,2	3,0		

## Sound power level, Lwi(A) [dB(A)]

Lwi(A)	a	b	c	d	e	f	g	h	j	k	m	n	p	q	r	s	t	u	v	w
4P	95	97	94	91	95	96	91	91	91	91	90	91	95	95	96	96	98	98	98	98
6P	84	86	83	81	85	86	81	80	81	80	80	81	84	84	85	85	88	87	88	88
8P	76	78	76	73	77	78	73	73	73	73	73	74	77	77	77	77	80	80	80	81

Plastic Duct

Lwi(A)	a	b	c	d	e	f	g	h	j	k	m	n	p	q	r	s	t	u	v	w
4P	93	95	92	89	93	94	89	89	89	89	88	89	93	93	94	94	96	96	96	96
6P	82	84	81	79	83	84	79	78	79	78	78	79	82	82	83	83	86	85	86	86
8P	74	76	74	71	75	76	71	71	71	71	71	72	75	75	75	75	78	78	78	79

\* Unlined Metal Duct

The A-weighted sound ratings shown have been calculated per AMCA International Standard 301. Values shown are for inlet Lwi(A) sound power levels for installation Type D: ducted inlet, ducted outlet. Ratings include the effects of duct end correction.

\* Sound power level with unlined metal duct were obtained from the test in the reverberant room. Data are not licensed by AMCA.

Fan test laboratory AMCA 210 Test Chamber. Performance certified is for installation type D - Ducted inlet, Ducted outlet. Performance ratings do not include the effects of appurtenances (accessories-belt cover, pulley & belt).

Dimensions + Accessories Page 191 - 194;  
Sound power frequency spectrum L<sub>w</sub> Page 196 - 200.





# Performance Curve

AXV 710-150-10, 50 Hz

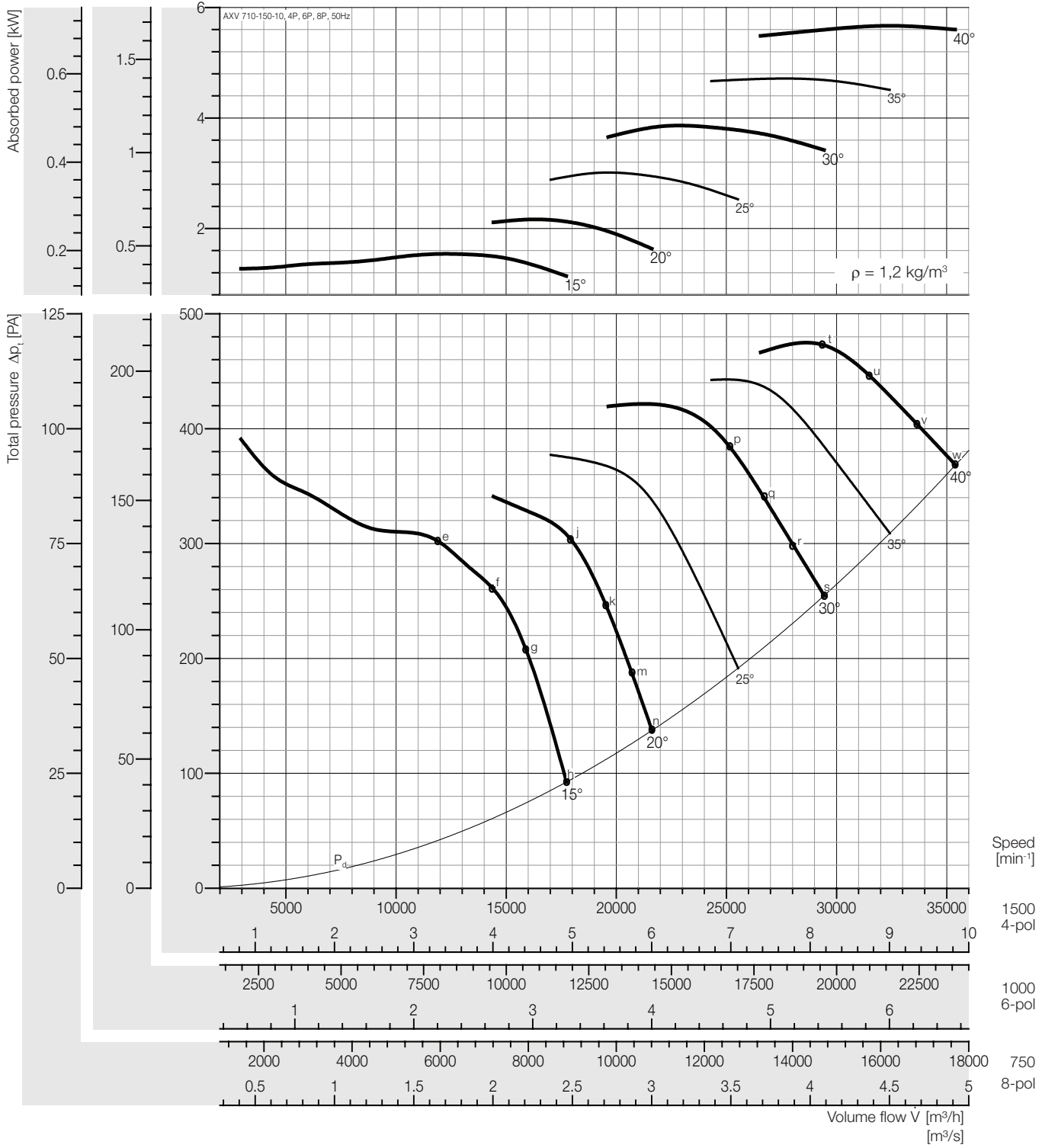

### Peak absorbed power [kW]

n [min <sup>-1</sup> ]	Pitch angle [°]						
	10	15	20	25	30	35	40
750	-	0,192	0,270	0,376	0,483	0,589	0,709
Motor		0,37		0,55		0,75	
1000	-	0,456	0,641	0,892	1,145	1,397	1,680
Motor		0,55	0,75	1,1	1,5		2,2
1500	-	1,538	2,163	3,012	3,863	4,714	5,669
Motor		2,2		4		-	

### Sound power level, Lwi(A) [dB(A)]

Lwi(A)	a	b	c	d	e	f	g	h	j	k	m	n	p	q	r	s	t	u	v	w
4P	-	-	-	-	99	96	93	94	94	94	95	96	98	97	98	99	99	99	100	100
6P	-	-	-	-	89	86	83	84	84	83	84	85	87	87	87	88	88	89	89	89
8P	-	-	-	-	82	79	77	77	77	76	77	78	80	80	80	81	81	81	82	82

Plastic Duct

Lwi(A)	a	b	c	d	e	f	g	h	j	k	m	n	p	q	r	s	t	u	v	w
4P	-	-	-	-	97	94	91	92	92	92	93	94	96	95	96	97	97	97	98	98
6P	-	-	-	-	87	84	81	82	82	81	82	83	85	85	85	86	86	87	87	87
8P	-	-	-	-	80	77	75	75	75	74	75	76	78	78	78	79	79	79	80	80

\* Unlined Metal Duct

Fan test laboratory AMCA 210 Test Chamber. Performance certified is for installation type D - Ducted inlet, Ducted outlet. Performance ratings do not include the effects of appurtenances (accessories-belt cover, pulley & belt).

Dimensions + Accessories Page 191 - 194;

Sound power frequency spectrum L<sub>w</sub> Page 196 - 200.

The A-weighted sound ratings shown have been calculated per AMCA International Standard 301. Values shown are for inlet LwiA sound power levels for installation Type D: ducted inlet, ducted outlet. Ratings include the effects of duct end correction.

\* Sound power level with unlined metal duct were obtained from the test in the reverberant room. Data are not licensed by AMCA.



# Performance Curve

AXV 710-250-7, 50 Hz

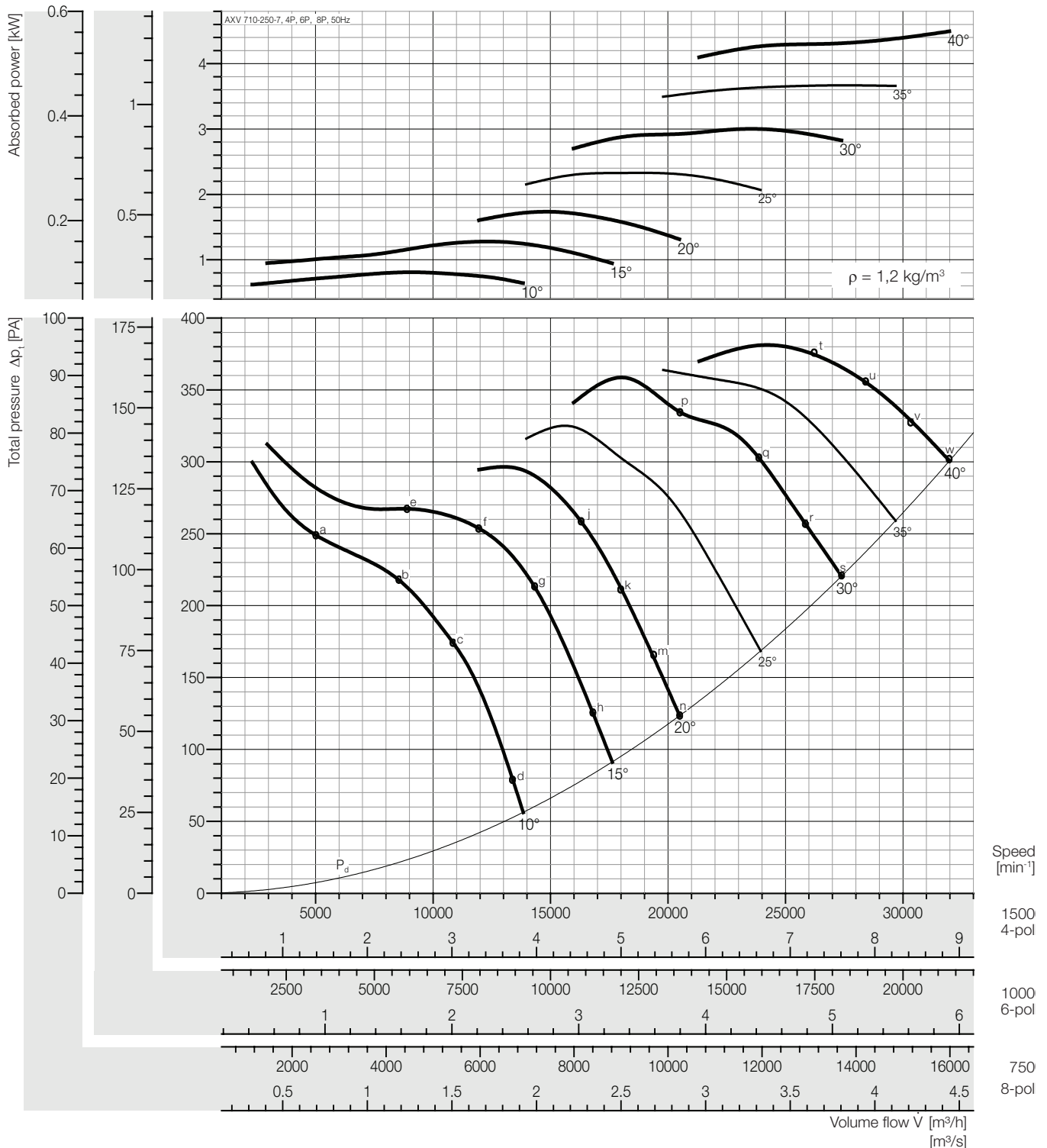

### Peak absorbed power [kW]

n [min <sup>-1</sup> ]	Pitch angle [°]						
	10	15	20	25	30	35	40
750	0,101	0,160	0,217	0,291	0,375	0,458	0,562
Motor	0,37				0,55		0,75
1000	0,239	0,378	0,514	0,690	0,889	1,087	1,332
Motor	0,37	0,55		0,75	1,1		1,5
1500	0,808	1,277	1,735	2,328	3,002	3,668	4,494
Motor	1,1	1,5	2,2	3,0		4,0	5,5

### Sound power level, Lwi(A) [dB(A)]

Lwi(A)	a	b	c	d	e	f	g	h	j	k	m	n	p	q	r	s	t	u	v	w
4P	96	98	96	91	99	97	92	93	92	92	92	87	96	97	97	97	99	99	99	100
6P	85	88	86	82	88	87	82	82	82	82	82	78	86	86	86	87	89	89	89	89
8P	77	80	79	75	80	80	75	75	75	75	75	71	79	79	79	79	81	81	82	82

Plastic Duct

Lwi(A)	a	b	c	d	e	f	g	h	j	k	m	n	p	q	r	s	t	u	v	w
4P	94	96	94	89	97	95	90	91	90	90	90	85	94	95	95	95	97	97	97	98
6P	83	86	84	80	86	85	80	80	80	80	80	76	84	84	84	85	87	87	87	87
8P	75	78	77	73	78	78	73	73	73	73	73	69	77	77	77	77	79	79	80	80

\* Unlined Metal Duct

Fan test laboratory AMCA 210 Test Chamber. Performance certified is for installation type D - Ducted inlet, Ducted outlet. Performance ratings do not include the effects of appurtenances (accessories-belt cover, pulley & belt).

Dimensions + Accessories Page 191 - 194;  
Sound power frequency spectrum L<sub>wnd</sub> Page 196 - 200.

The A-weighted sound ratings shown have been calculated per AMCA International Standard 301. Values shown are for inlet LwiA sound power levels for installation Type D: ducted inlet, ducted outlet. Ratings include the effects of duct end correction.

\* Sound power level with unlined metal duct were obtained from the test in the reverberant room. Data are not licensed by AMCA.



# Performance Curve

AXV 710-250-9, 50 Hz

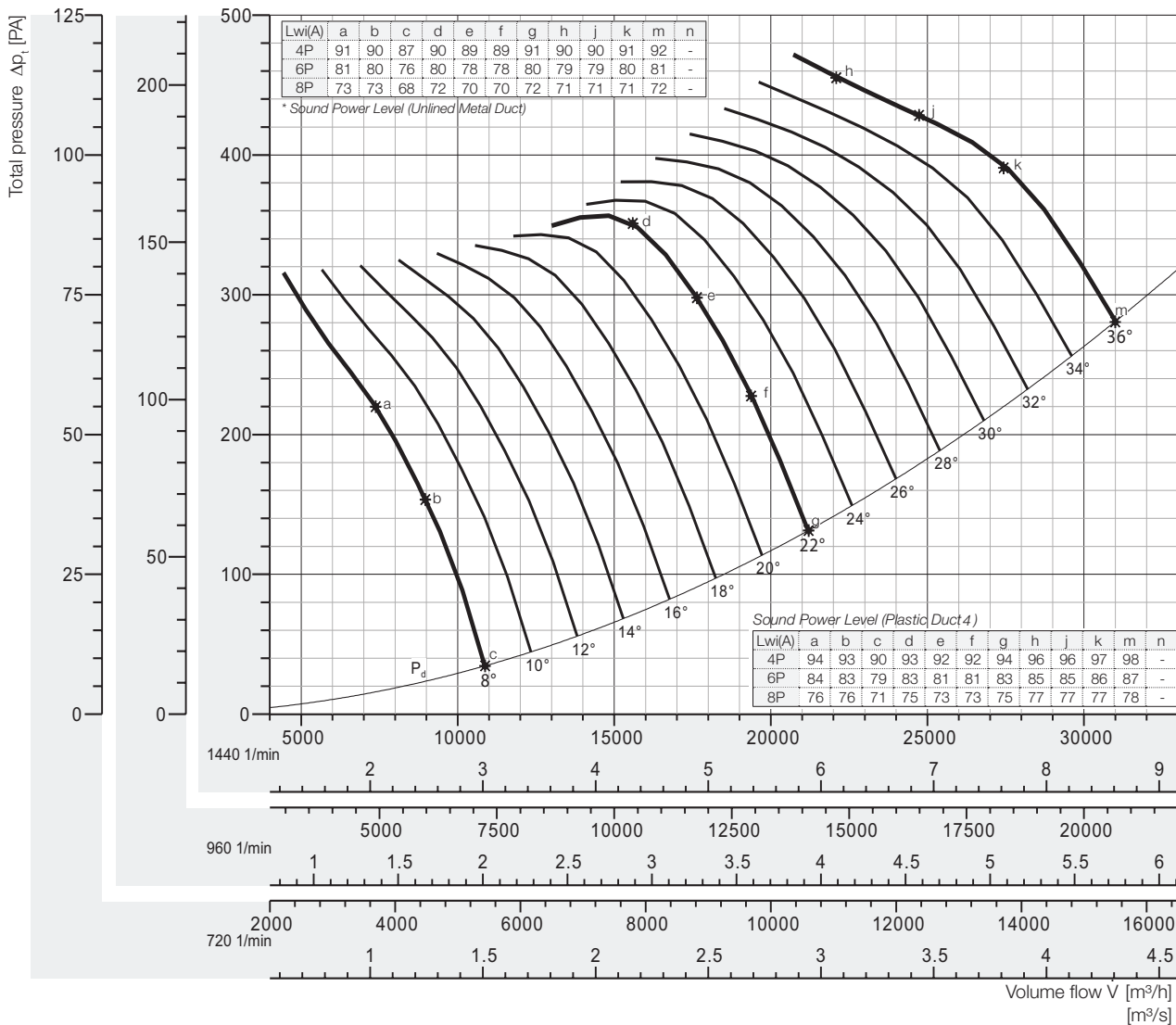
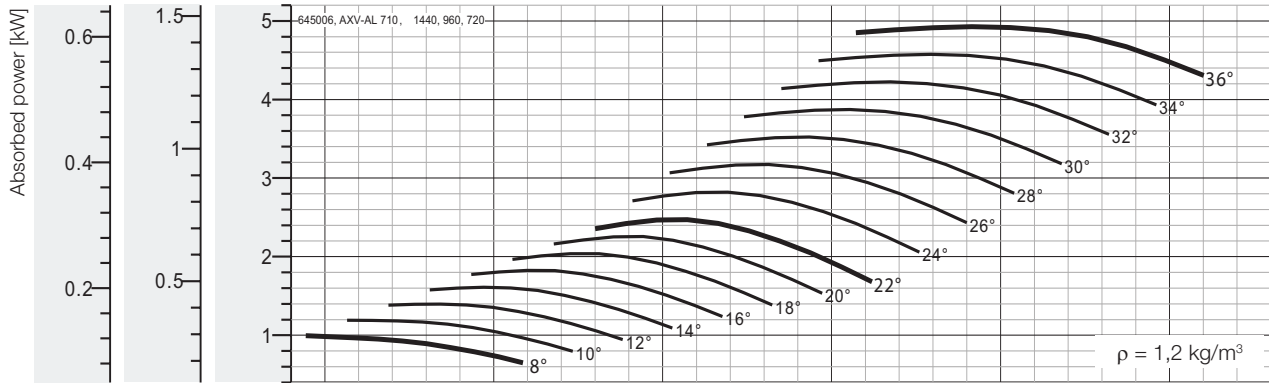

## Peak absorbed power [kW]

n [min <sup>-1</sup> ]	Pitch angle [°]														38	40	
	8	10	12	14	16	18	20	22	24	26	28	30	32	34			36
720 motor	0,125	0,149	0,175	0,201	0,228	0,255	0,282	0,309	0,353	0,397	0,440	0,484	0,528	0,572	0,616	-	-
	0,37									0,55				0,75			
960 motor	0,295	0,353	0,414	0,477	0,541	0,604	0,668	0,732	0,836	0,940	1,04	1,15	1,25	1,36	1,46	-	-
	0,37	0,55			0,75			1,1			1,5						
1440 motor	0,996	1,19	1,40	1,61	1,83	2,04	2,26	2,47	2,82	3,17	3,52	3,87	4,22	4,58	4,93	-	-
	1,1	1,5		2,2		3			4			5,5					

Fan test laboratory AMCA 210 Test Chamber. Performance certified is for installation type D - Ducted inlet, Ducted outlet. Performance ratings do not include the effects of appurtenances (accessories-belt cover, pulley & belt).

Dimensions + Accessories Page 191 ~ 194;  
Sound power frequency spectrum L<sub>max</sub> Page 196 ~ 200.

The A-weighted sound ratings shown have been calculated per AMCA International Standard 301. Values shown are for inlet Lw<sub>i</sub> sound power levels for installation Type D: ducted inlet, ducted outlet. Ratings include the effects of duct end correction.

\* Sound power level with unlined metal duct were obtained from the test in the reverberant room. Data are not licensed by AMCA.



# Performance Curve

AXV 710-250-14, 50 Hz

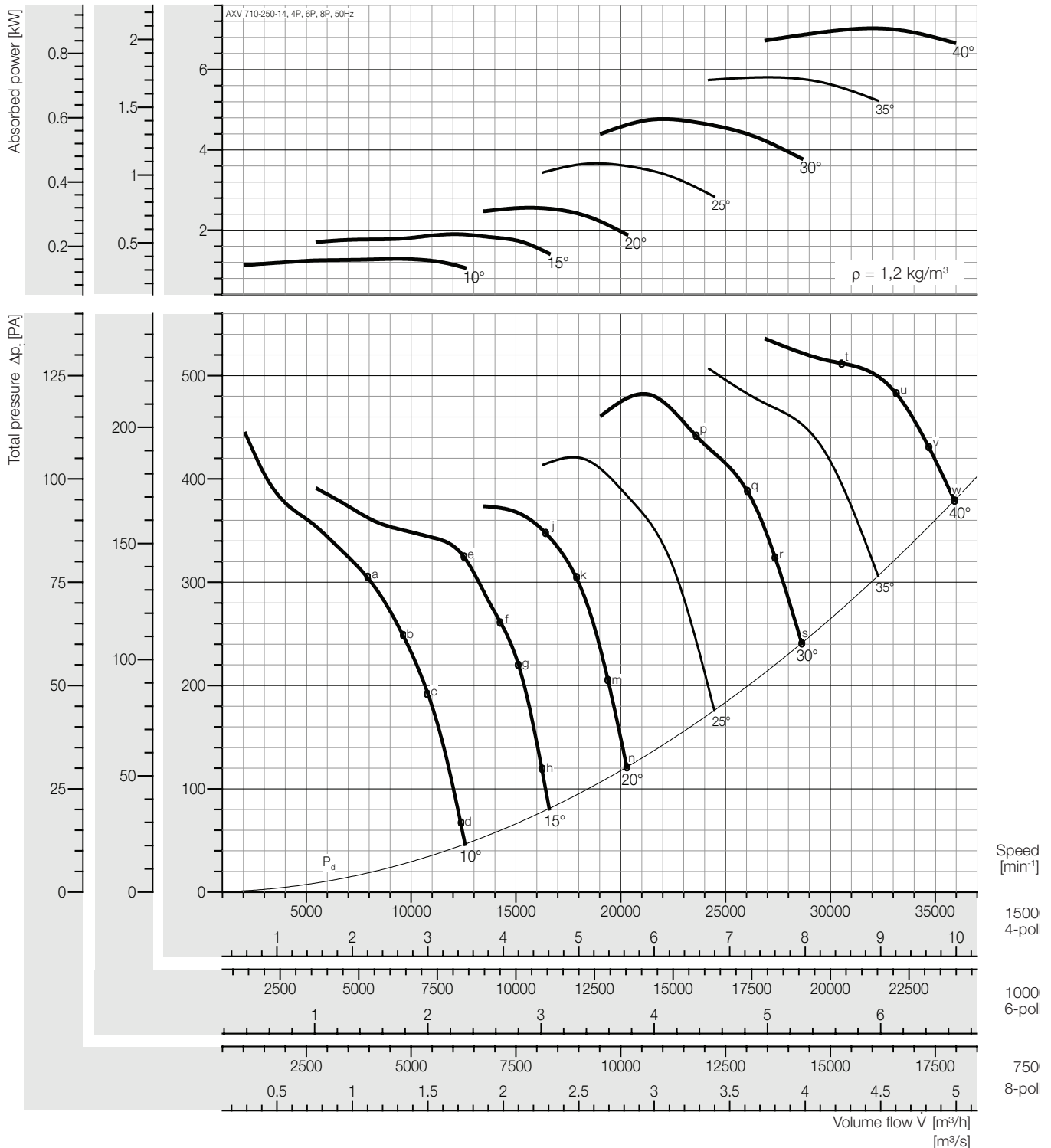

## Peak absorbed power [kW]

n [min <sup>-1</sup> ]	Pitch angle [°]						
	10	15	20	25	30	35	40
750	0,161	0,237	0,320	0,458	0,596	0,726	0,878
Motor	0,37			0,55		0,75	1,1
1000	0,381	0,562	0,759	1,086	1,412	1,720	2,082
Motor	0,55	0,75	1,1		1,5	2,2	
1500	1,287	1,897	2,560	3,664	4,767	5,807	7,027
Motor	1,5	2,2	3,0	4,0	5,5	7,5	11

## Sound power level, Lwi(A) [dB(A)]

Lwi(A)	a	b	c	d	e	f	g	h	j	k	m	n	p	q	r	s	t	u	v	w
4P	98	99	98	96	100	96	94	96	96	95	95	96	98	98	99	100	100	101	101	101
6P	87	89	89	86	90	86	85	86	86	85	85	86	88	88	89	90	90	90	91	91
8P	80	81	82	79	83	79	78	79	79	78	78	79	81	81	81	82	83	83	84	84

Plastic Duct

Lwi(A)	a	b	c	d	e	f	g	h	j	k	m	n	p	q	r	s	t	u	v	w
4P	96	97	96	94	98	94	92	94	94	93	93	94	96	96	97	98	98	99	99	99
6P	85	87	87	84	88	84	83	84	84	83	83	84	86	86	87	88	88	88	89	89
8P	78	79	80	77	81	77	76	77	77	76	76	77	79	79	79	80	81	81	82	82

\* Unlined Metal Duct

Fan test laboratory AMCA 210 Test Chamber. Performance certified is for installation type D - Ducted inlet, Ducted outlet. Performance ratings do not include the effects of appurtenances (accessories-belt cover, pulley & belt).

Dimensions + Accessories Page 191 - 194;  
Sound power frequency spectrum L<sub>w</sub> Page 196 - 200.

The A-weighted sound ratings shown have been calculated per AMCA International Standard 301. Values shown are for inlet Lwi(A) sound power levels for installation Type D: ducted inlet, ducted outlet. Ratings include the effects of duct end correction.

\* Sound power level with unlined metal duct were obtained from the test in the reverberant room. Data are not licensed by AMCA.



# Performance Curve

AXV 800-150-5, 50 Hz

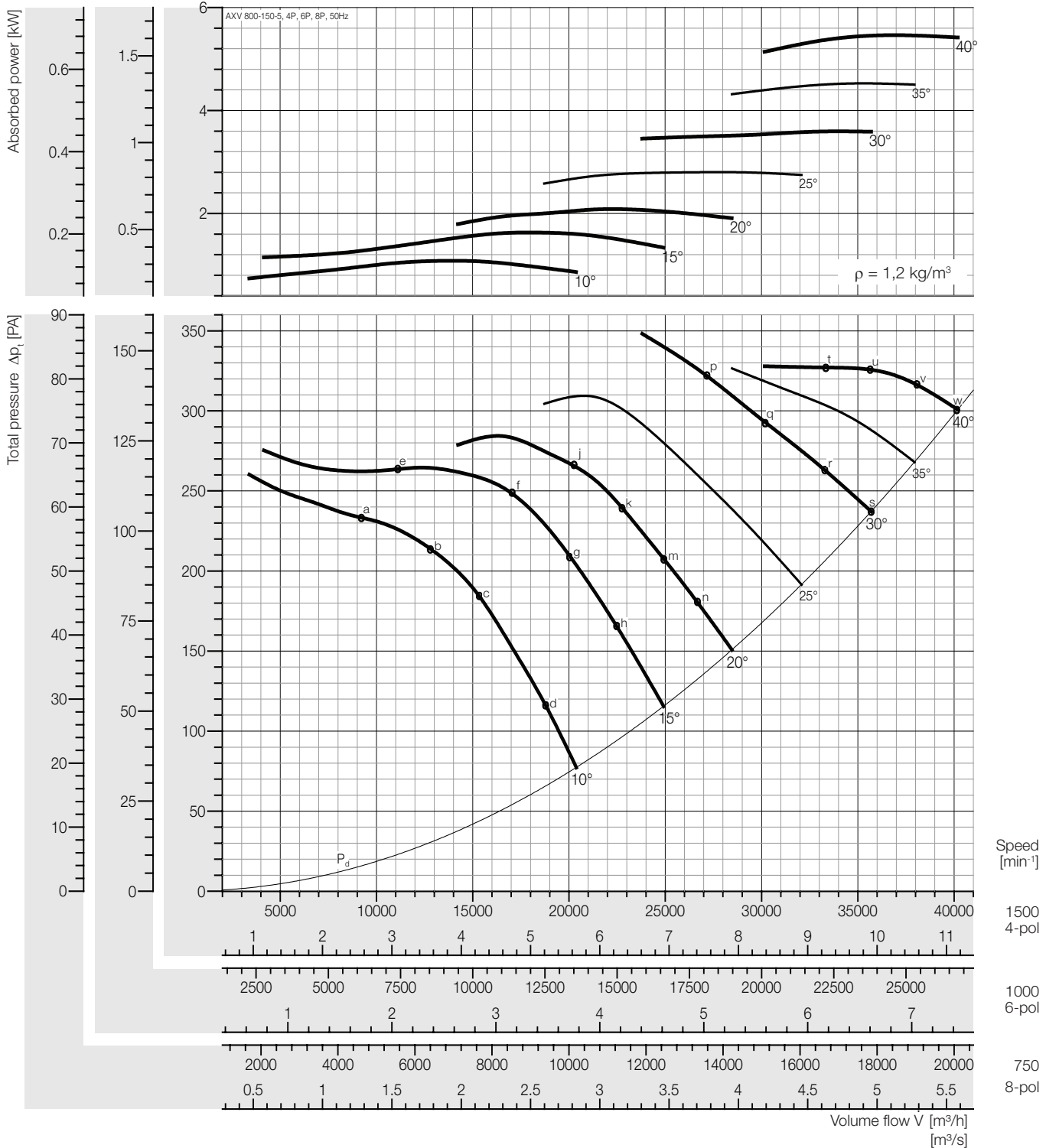

### Peak absorbed power [kW]

n [min <sup>-1</sup> ]	Pitch angle [°]						
	10	15	20	25	30	35	40
750	0,135	0,204	0,261	0,350	0,449	0,566	0,683
Motor	0,37				0,55	0,75	
1000	0,319	0,483	0,618	0,830	1,065	1,341	1,619
Motor	0,37	0,55	0,75	1,1		1,5	2,2
1500	1,078	1,630	2,085	2,802	3,594	4,526	5,463
Motor	1,1	2,2		3,0	4,0	-	

### Sound power level, Lwi(A) [dB(A)]

Lwi(A)	a	b	c	d	e	f	g	h	j	k	m	n	p	q	r	s	t	u	v	w
4P	101	100	97	95	102	96	95	95	96	96	96	97	100	100	100	101	101	101	101	101
6P	90	89	87	85	91	86	84	84	85	85	85	85	88	88	88	89	90	89	90	90
8P	82	82	79	78	83	78	76	76	77	78	77	78	81	80	81	81	82	82	82	82

Plastic Duct

Lwi(A)	a	b	c	d	e	f	g	h	j	k	m	n	p	q	r	s	t	u	v	w
4P	99	98	95	93	100	94	93	93	94	94	94	95	98	98	98	99	99	99	99	99
6P	88	87	85	83	89	84	82	82	83	83	83	83	86	86	86	87	88	87	88	88
8P	80	80	77	76	81	76	74	74	75	76	75	76	79	78	79	79	80	80	80	80

\* Unlined Metal Duct

The A-weighted sound ratings shown have been calculated per AMCA International Standard 301. Values shown are for inlet LwiA sound power levels for installation Type D: ducted inlet, ducted outlet. Ratings include the effects of duct end correction.

\* Sound power level with unlined metal duct were obtained from the test in the reverberant room. Data are not licensed by AMCA.

Fan test laboratory AMCA 210 Test Chamber. Performance certified is for installation type D - Ducted inlet, Ducted outlet. Performance ratings do not include the effects of appurtenances (accessories-belt cover, pulley & belt).

Dimensions + Accessories Page 191 - 194;

Sound power frequency spectrum L<sub>w</sub> Page 196 - 200.



# Performance Curve

AXV 800-150-10, 50 Hz

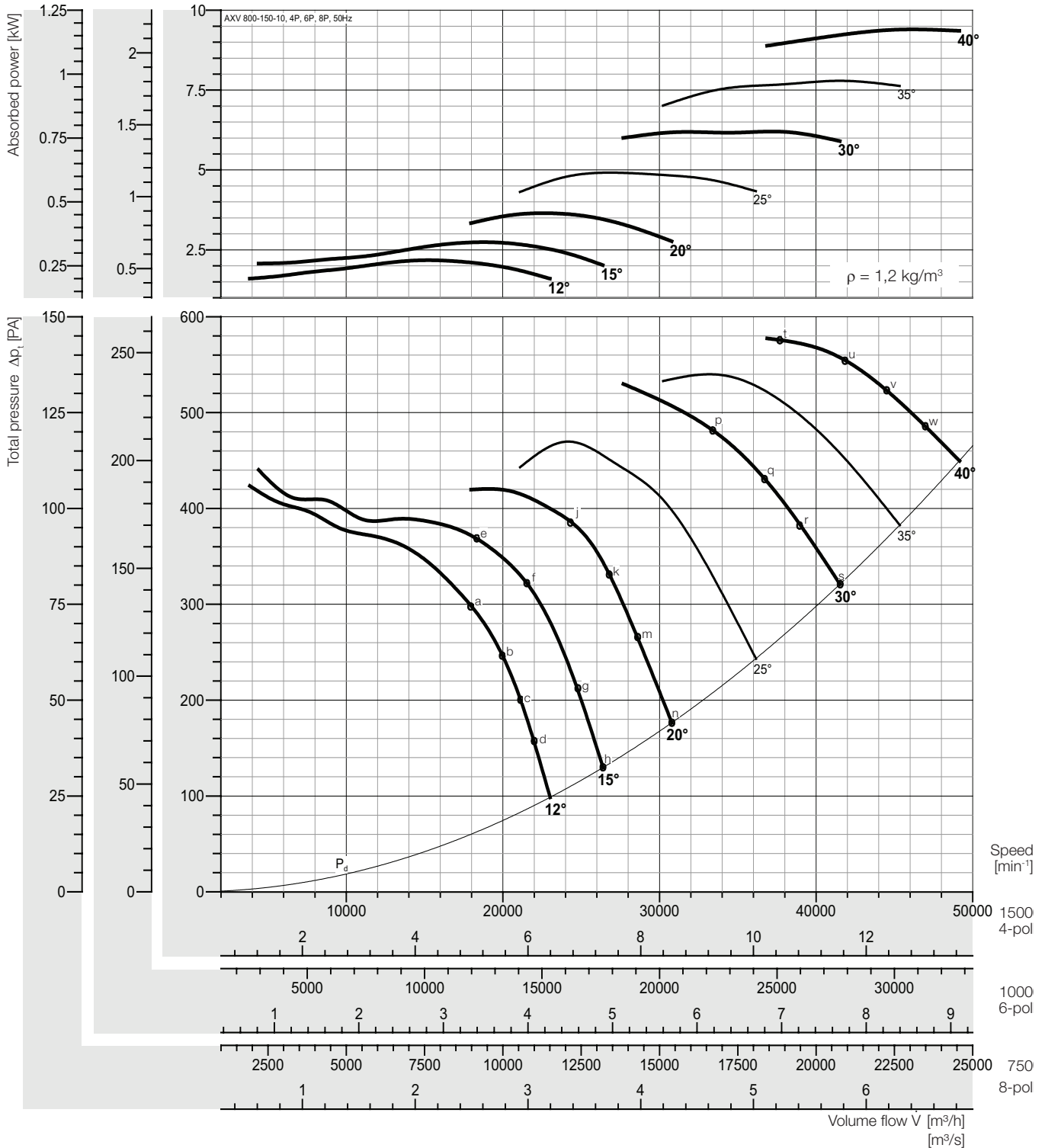

## Peak absorbed power [kW]

n [min <sup>-1</sup> ]	Pitch angle [°]						
	10	15	20	25	30	35	40
750	0,271	0,342	0,456	0,614	0,775	0,973	1,175
Motor	0,37		0,55	0,75	1,1		1,5
1000	0,643	0,812	1,081	1,455	1,837	2,307	2,785
Motor	0,75	1,1		1,5	2,2	3,0	
1500	2,169	2,739	3,647	4,909	6,201	7,786	9,399
Motor	2,2	3,0	4,0	-			

## Sound power level, Lwi(A) [dB(A)]

Lwi(A)	a	b	c	d	e	f	g	h	j	k	m	n	p	q	r	s	t	u	v	w
4P	101	98	98	98	103	100	99	99	100	100	100	101	102	102	102	102	101	102	102	102
6P	91	87	87	87	92	88	88	88	89	89	89	89	90	90	90	90	91	91	91	92
8P	84	80	80	80	84	81	81	81	81	81	81	82	82	82	82	83	83	84	84	84

Plastic Duct

Lwi(A)	a	b	c	d	e	f	g	h	j	k	m	n	p	q	r	s	t	u	v	w
4P	99	96	96	96	101	98	97	97	98	98	98	99	100	100	100	100	99	100	100	100
6P	89	85	85	85	90	86	86	86	87	87	87	87	88	88	88	88	89	89	89	90
8P	82	78	78	78	82	79	79	79	79	79	79	80	80	80	80	81	81	82	82	82

\* Unlined Metal Duct

Fan test laboratory AMCA 210 Test Chamber. Performance certified is for installation type D - Ducted inlet, Ducted outlet. Performance ratings do not include the effects of appurtenances (accessories-belt cover, pulley & belt).

Dimensions + Accessories Page 191 - 194;  
Sound power frequency spectrum L<sub>wnd</sub> Page 196 - 200.

The A-weighted sound ratings shown have been calculated per AMCA International Standard 301. Values shown are for inlet LwiA sound power levels for installation Type D: ducted inlet, ducted outlet. Ratings include the effects of duct end correction.

\* Sound power level with unlined metal duct were obtained from the test in the reverberant room. Data are not licensed by AMCA.



# Performance Curve

AXV 800-250-7, 50 Hz

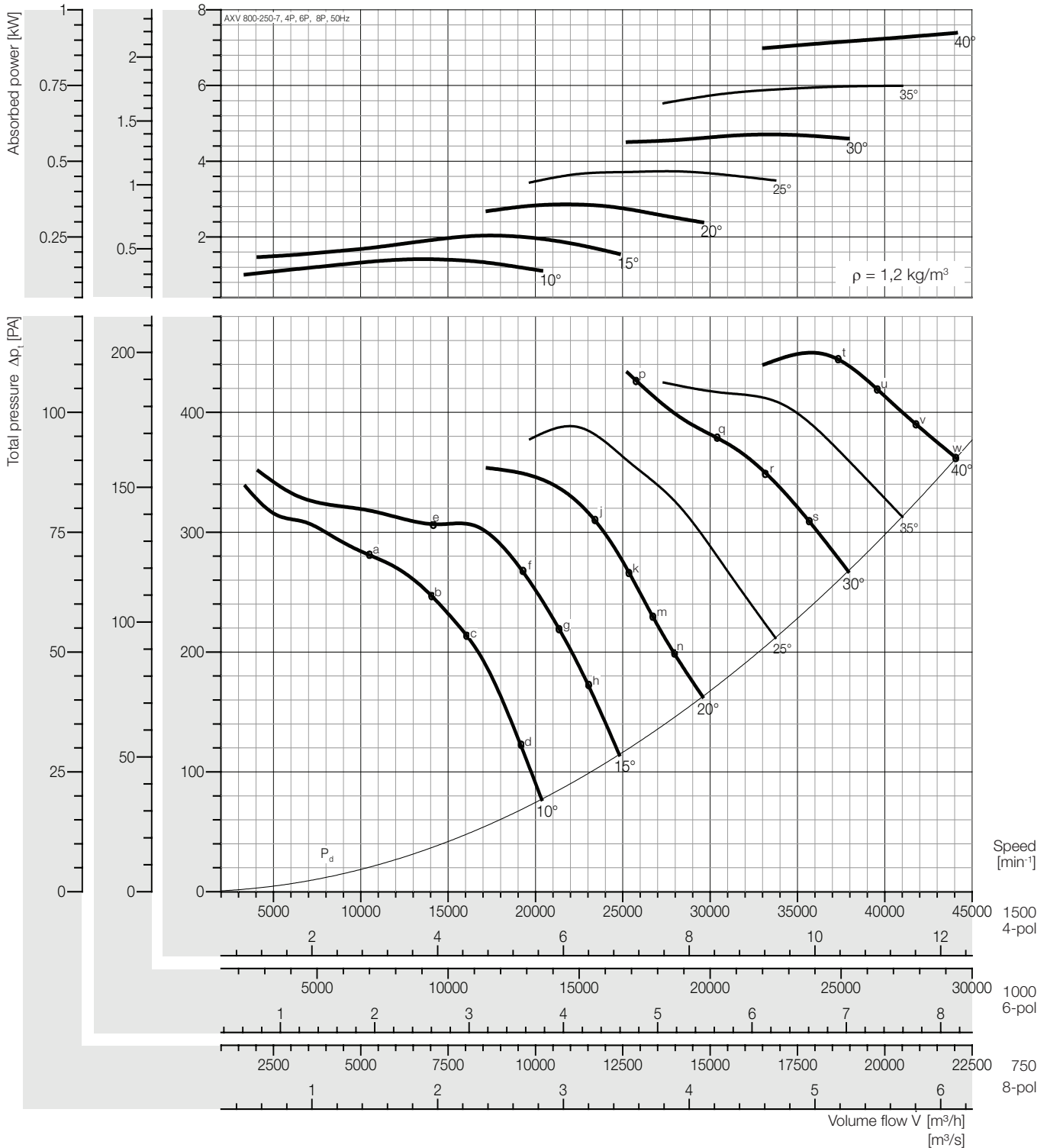

### Peak absorbed power [kW]

n [min <sup>-1</sup> ]	Pitch angle [°]						
	10	15	20	25	30	35	40
750	0,176	0,254	0,357	0,467	0,588	0,749	0,924
Motor	0,37			0,55	0,75		1,1
1000	0,417	0,603	0,847	1,107	1,394	1,776	2,190
Motor	0,55	0,75	1,1	1,5		2,2	
1500	1,408	2,034	2,859	3,735	4,706	5,994	7,390
Motor	1,5	2,2	3,0	4,0	5,5	7,5	

### Sound power level, Lwi(A) [dB(A)]

Lwi(A)	a	b	c	d	e	f	g	h	j	k	m	n	p	q	r	s	t	u	v	w
4P	102	101	98	97	102	97	96	96	96	96	96	97	96	97	98	98	101	101	101	102
6P	91	90	88	87	92	87	85	86	85	86	86	86	86	87	87	88	91	91	91	91
8P	83	83	81	80	84	79	78	79	78	78	78	79	79	80	80	80	83	83	83	84

Plastic Duct

Lwi(A)	a	b	c	d	e	f	g	h	j	k	m	n	p	q	r	s	t	u	v	w
4P	100	99	96	95	100	95	94	94	94	94	94	95	94	95	96	96	99	99	99	100
6P	89	88	86	85	90	85	83	84	83	84	84	84	84	85	85	86	89	89	89	89
8P	81	81	79	78	82	77	76	77	76	76	76	77	77	78	78	78	81	81	81	82

\* Unlined Metal Duct

Fan test laboratory AMCA 210 Test Chamber. Performance certified is for installation type D - Ducted inlet, Ducted outlet. Performance ratings do not include the effects of appurtenances (accessories-belt cover, pulley & belt).

Dimensions + Accessories Page 191 - 194;  
Sound power frequency spectrum L<sub>w</sub> Page 196 - 200.

The A-weighted sound ratings shown have been calculated per AMCA International Standard 301. Values shown are for inlet LwiA sound power levels for installation Type D: ducted inlet, ducted outlet. Ratings include the effects of duct end correction.

\* Sound power level with unlined metal duct were obtained from the test in the reverberant room. Data are not licensed by AMCA.



# Performance Curve

AXV 800-250-9, 50 Hz

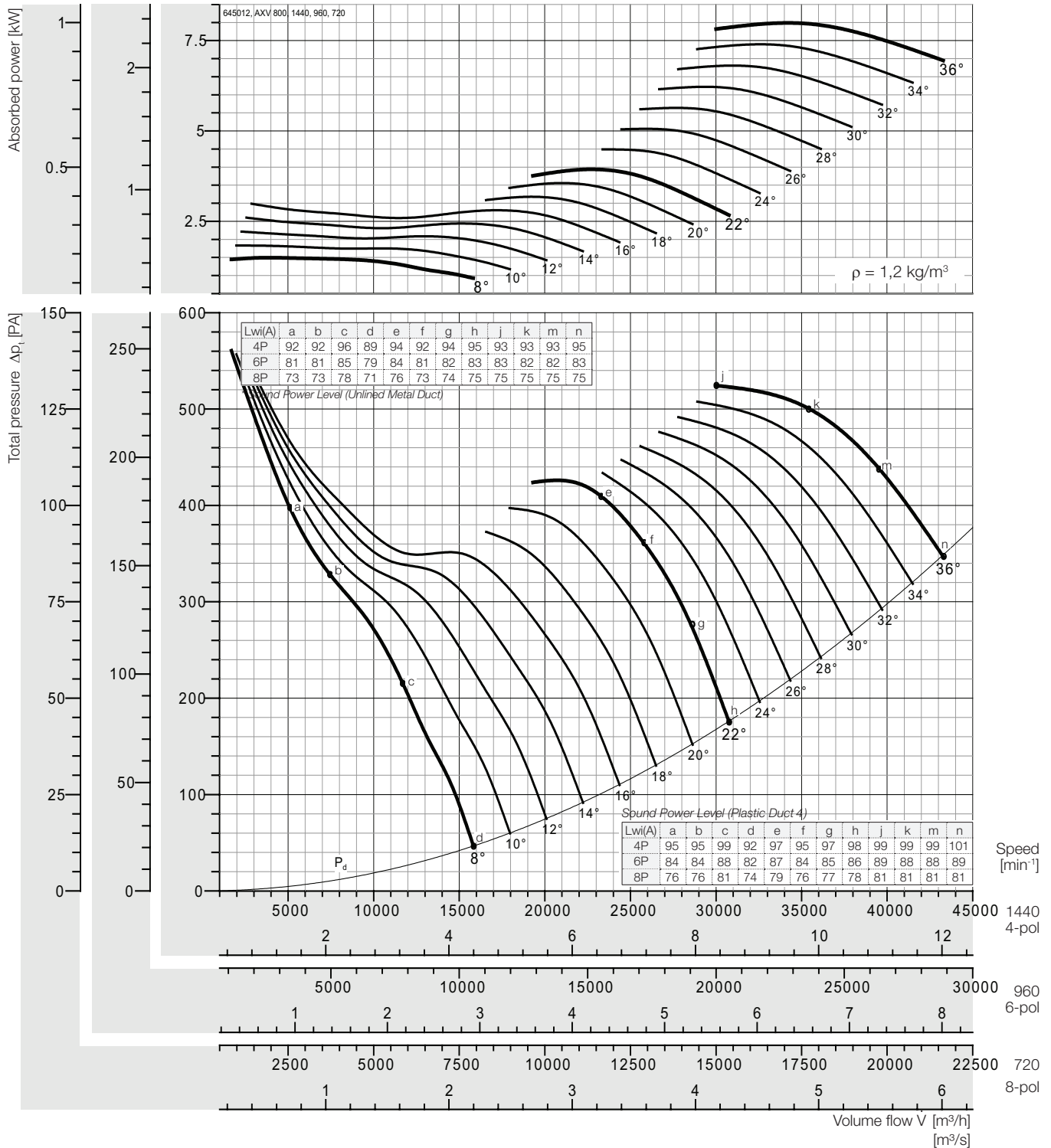

## Peak absorbed power [kW]

n [min <sup>-1</sup> ]	Pitch angle [°]																
	8	10	12	14	16	18	20	22	24	26	28	30	32	34	36	38	40
720 motor	0,187	0,229	0,277	0,325	0,373	0,397	0,445	0,492	0,561	0,632	0,705	0,778	0,851	0,925	0,999	-	-
	0,37				0,55				0,75			1,1					
960 motor	0,443	0,543	0,657	0,771	0,885	0,942	1,05	1,17	1,33	1,50	1,67	1,84	2,02	2,19	2,37	-	-
	0,55		0,75	1,1			1,5			2,2			3				
1440 motor	1,49	1,83	2,22	2,60	2,99	3,18	3,56	3,94	4,49	5,06	5,64	6,22	6,81	7,40	7,99	-	-
	1,5	2,2	3			4			5,5		7,5			11			

Fan test laboratory AMCA 210 Test Chamber. Performance certified is for installation type D - Ducted inlet, Ducted outlet. Performance ratings do not include the effects of appurtenances (accessories-belt cover, pulley & belt).

Dimensions + Accessories Page 191 - 194;  
Sound power frequency spectrum L<sub>w</sub> Page 196 - 200.

The A-weighted sound ratings shown have been calculated per AMCA International Standard 301. Values shown are for inlet Lw(A) sound power levels for installation Type D: ducted inlet, ducted outlet. Ratings include the effects of duct end correction.

\* Sound power level with unlined metal duct were obtained from the test in the reverberant room.  
Data are not licensed by AMCA.





# Performance Curve

AXV 800-250-14, 50 Hz

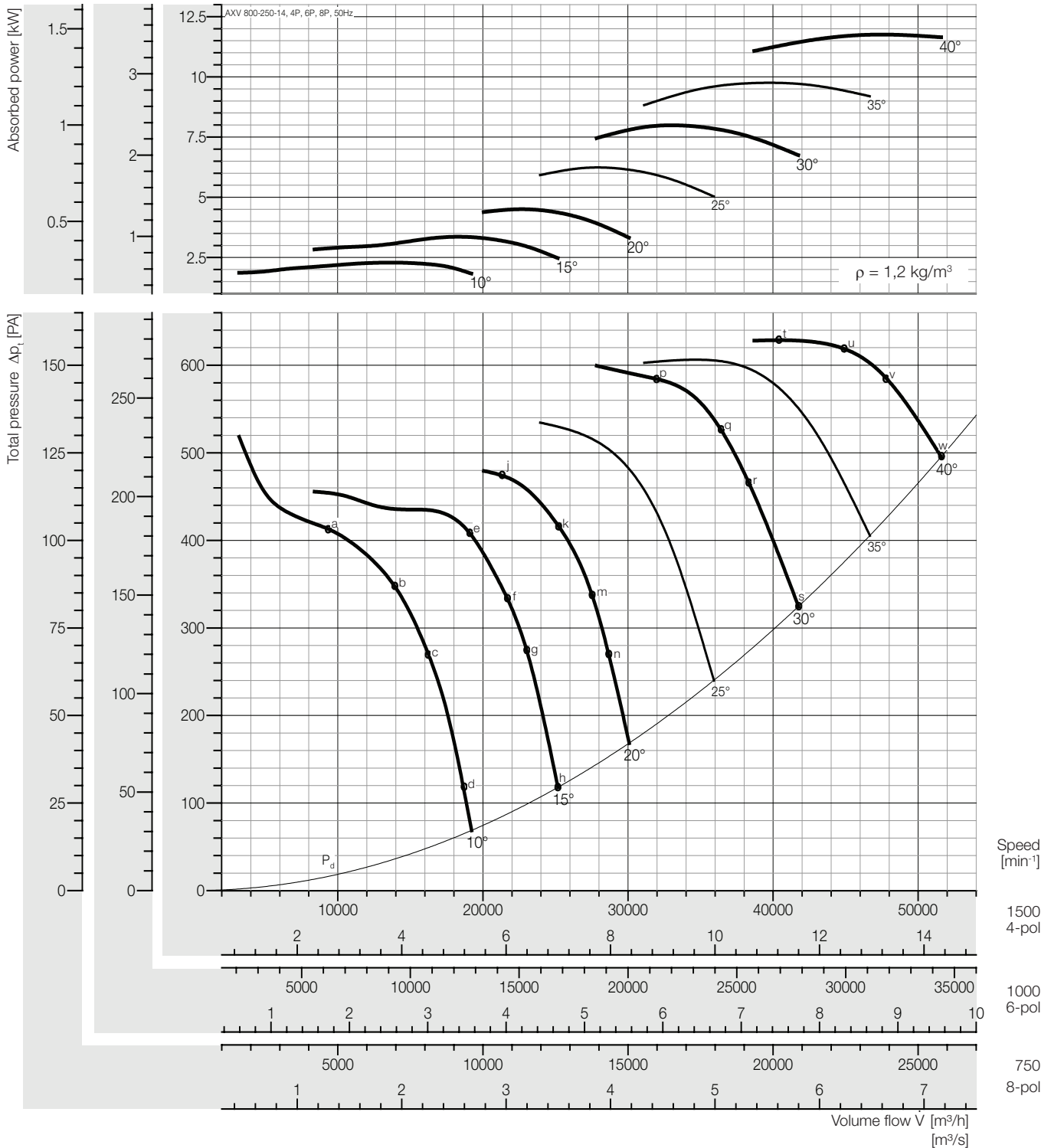

### Peak absorbed power [kW]

n [min <sup>-1</sup> ]	Pitch angle [°]						
	10	15	20	25	30	35	40
750	0,286	0,419	0,563	0,780	0,998	1,219	1,470
Motor	0,37	0,55	0,75	1,1		1,5	
1000	0,678	0,994	1,334	1,849	2,366	2,890	3,484
Motor	0,75	1,1	1,5	2,2	3,0	4,0	
1500	2,289	3,354	4,502	6,239	7,985	9,754	11,76
Motor	3,0	4,0	5,5	7,5	11		

### Sound power level, Lwi(A) [dB(A)]

Lwi(A)	a	b	c	d	e	f	g	h	j	k	m	n	p	q	r	s	t	u	v	w
4P	102	103	101	100	103	99	97	99	104	100	99	100	100	100	101	101	102	103	103	104
6P	91	93	92	90	93	89	88	90	94	90	89	91	90	90	91	91	92	93	93	94
8P	83	85	84	83	85	82	81	83	86	82	81	83	83	82	82	83	83	84	84	85

Plastic Duct

Lwi(A)	a	b	c	d	e	f	g	h	j	k	m	n	p	q	r	s	t	u	v	w
4P	100	101	99	98	101	97	95	97	102	98	97	98	98	98	99	99	100	101	101	102
6P	89	91	90	88	91	87	86	88	92	88	87	89	88	88	89	89	90	91	91	92
8P	81	83	82	81	83	80	79	82	84	80	79	81	81	80	80	81	81	82	82	83

\* Unlined Metal Duct

Fan test laboratory AMCA 210 Test Chamber. Performance certified is for installation type D - Ducted inlet, Ducted outlet. Performance ratings do not include the effects of appurtenances (accessories-belt cover, pulley & belt).

Dimensions + Accessories Page 191 - 194;

Sound power frequency spectrum L<sub>w</sub> Page 196 - 200.

The A-weighted sound ratings shown have been calculated per AMCA International Standard 301. Values shown are for inlet LwiA sound power levels for installation Type D: ducted inlet, ducted outlet. Ratings include the effects of duct end correction.

\* Sound power level with unlined metal duct were obtained from the test in the reverberant room. Data are not licensed by AMCA.



# Performance Curve

AXV 900-250-7, 50 Hz

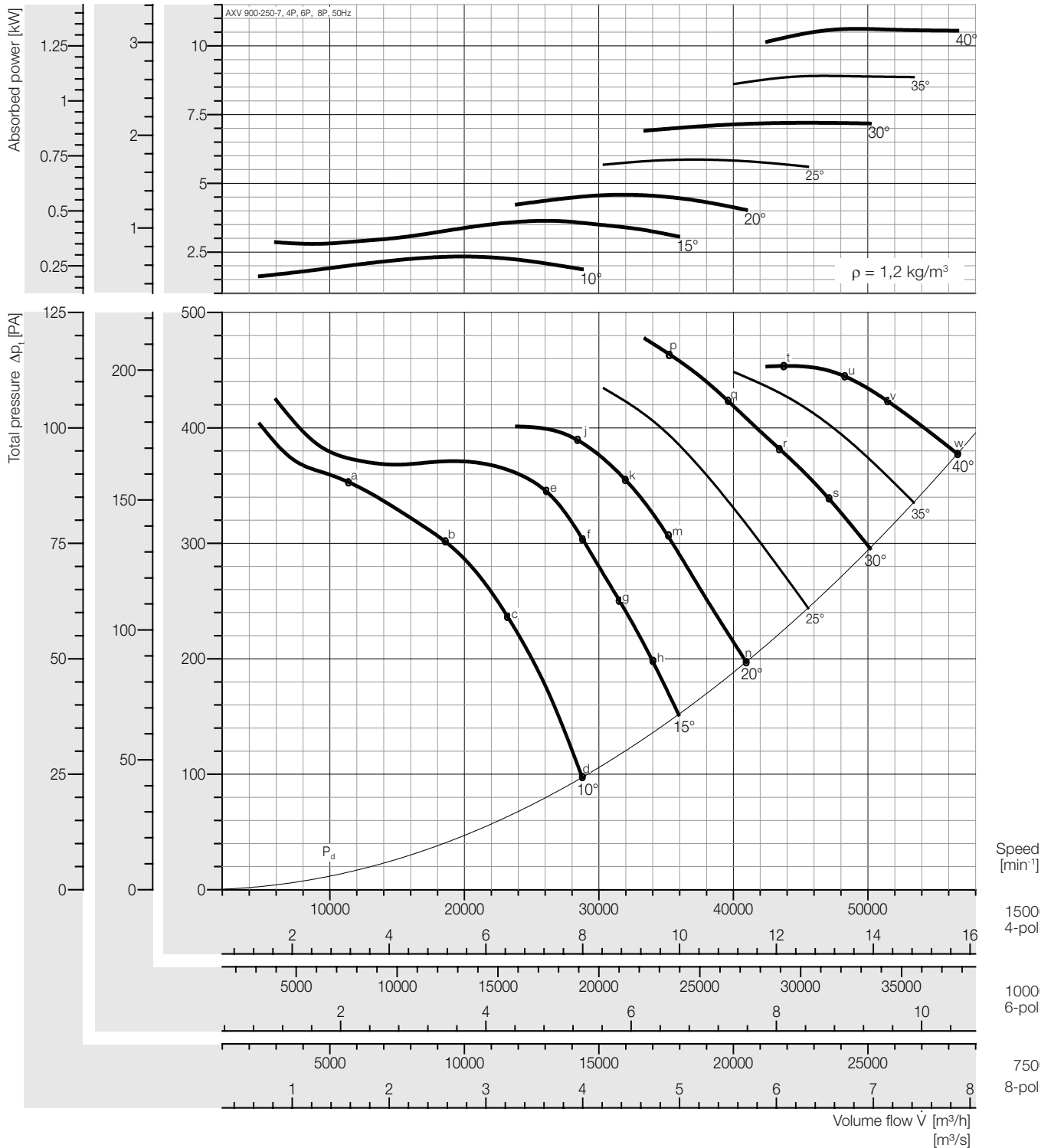

### Peak absorbed power [kW]

n [min <sup>-1</sup> ]	Pitch angle [°]						
	10	15	20	25	30	35	40
750	0,292	0,455	0,573	0,733	0,900	1,113	1,327
Motor	0,37	0,55	0,75	1,1	1,5		
1000	0,691	1,078	1,359	1,738	2,134	2,639	3,146
Motor	0,75	1,1	1,5	2,2	3,0	4,0	
1500	2,334	3,639	4,586	5,864	7,201	8,906	10,62
Motor	3,0	4,0	5,5	7,5	11		

### Sound power level, Lwi(A) [dB(A)]

Lwi(A)	a	b	c	d	e	f	g	h	j	k	m	n	p	q	r	s	t	u	v	w
4P	101	104	99	95	99	96	95	95	98	96	95	96	100	99	99	99	106	101	100	101
6P	91	94	89	86	89	87	86	86	88	86	86	87	90	90	89	89	95	91	90	91
8P	83	86	82	80	82	80	79	79	82	80	79	80	83	83	83	82	88	84	83	84

Plastic Duct

Lwi(A)	a	b	c	d	e	f	g	h	j	k	m	n	p	q	r	s	t	u	v	w
4P	99	102	97	93	97	94	93	93	96	94	93	94	98	97	97	97	104	99	98	99
6P	89	92	87	84	87	85	84	84	86	84	84	85	88	88	87	87	93	89	88	89
8P	81	84	80	78	80	78	77	77	80	78	77	78	81	81	81	80	86	82	81	82

\* Unlined Metal Duct

Fan test laboratory AMCA 210 Test Chamber. Performance certified is for installation type D - Ducted inlet, Ducted outlet. Performance ratings do not include the effects of appurtenances (accessories-belt cover, pulley & belt).

Dimensions + Accessories Page 191 - 194;  
Sound power frequency spectrum L<sub>wnd</sub> Page 196 - 200.

The A-weighted sound ratings shown have been calculated per AMCA International Standard 301. Values shown are for inlet Lwi(A) sound power levels for installation Type D: ducted inlet, ducted outlet. Ratings include the effects of duct end correction.

\* Sound power level with unlined metal duct were obtained from the test in the reverberant room. Data are not licensed by AMCA.



# Performance Curve

AXV 900-250-14, 50 Hz

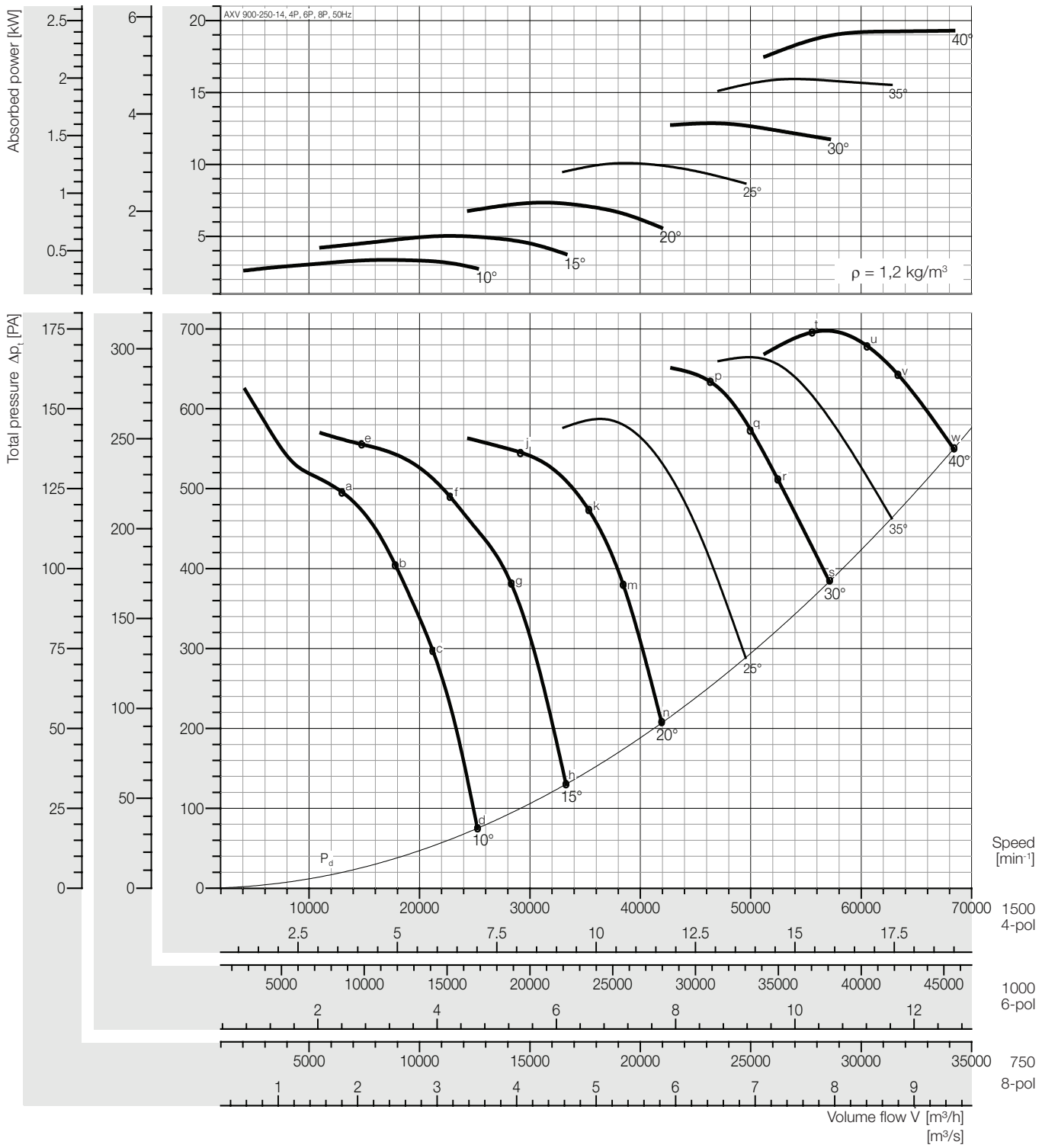

### Peak absorbed power [kW]

n [min <sup>-1</sup> ]	Pitch angle [°]						
	10	15	20	25	30	35	40
750	0,419	0,628	0,916	1,261	1,607	1,991	2,412
Motor	0,55	0,75	1,1	1,5	2,2	3,0	
1000	0,993	1,488	2,172	2,990	3,809	4,720	5,717
Motor	1,1	1,5	2,2	3,0	4,0	5,5	7,5
1500	3,350	5,022	7,330	10,09	12,86	15,93	19,29
Motor	4,0	5,5	7,5	11	-		

### Sound power level, Lwi(A) [dB(A)]

Lwi(A)	a	b	c	d	e	f	g	h	j	k	m	n	p	q	r	s	t	u	v	w
4P	104	105	104	102	105	107	103	100	107	101	99	100	100	100	100	101	102	101	102	103
6P	94	95	95	93	94	97	94	92	97	92	90	91	91	91	90	91	92	92	92	93
8P	86	88	88	86	87	89	87	85	90	85	84	85	84	83	83	84	85	85	85	86

Plastic Duct

Lwi(A)	a	b	c	d	e	f	g	h	j	k	m	n	p	q	r	s	t	u	v	w
4P	102	103	102	100	103	105	101	98	105	99	97	98	98	98	98	99	100	99	100	101
6P	92	93	93	91	92	95	92	90	95	90	88	89	89	89	88	89	90	90	90	91
8P	84	86	86	84	85	87	85	83	88	83	82	83	82	81	81	82	83	83	83	84

\* Unlined Metal Duct

Fan test laboratory AMCA 210 Test Chamber. Performance certified is for installation type D - Ducted inlet, Ducted outlet. Performance ratings do not include the effects of appurtenances (accessories-belt cover, pulley & belt).

Dimensions + Accessories Page 191 - 194;  
Sound power frequency spectrum L<sub>w</sub> Page 196 - 200.

The A-weighted sound ratings shown have been calculated per AMCA International Standard 301. Values shown are for inlet Lwi(A) sound power levels for installation Type D: ducted inlet, ducted outlet. Ratings include the effects of duct end correction.

\* Sound power level with unlined metal duct were obtained from the test in the reverberant room. Data are not licensed by AMCA.



# Performance Curve

AXV 900-300-10, 50 Hz

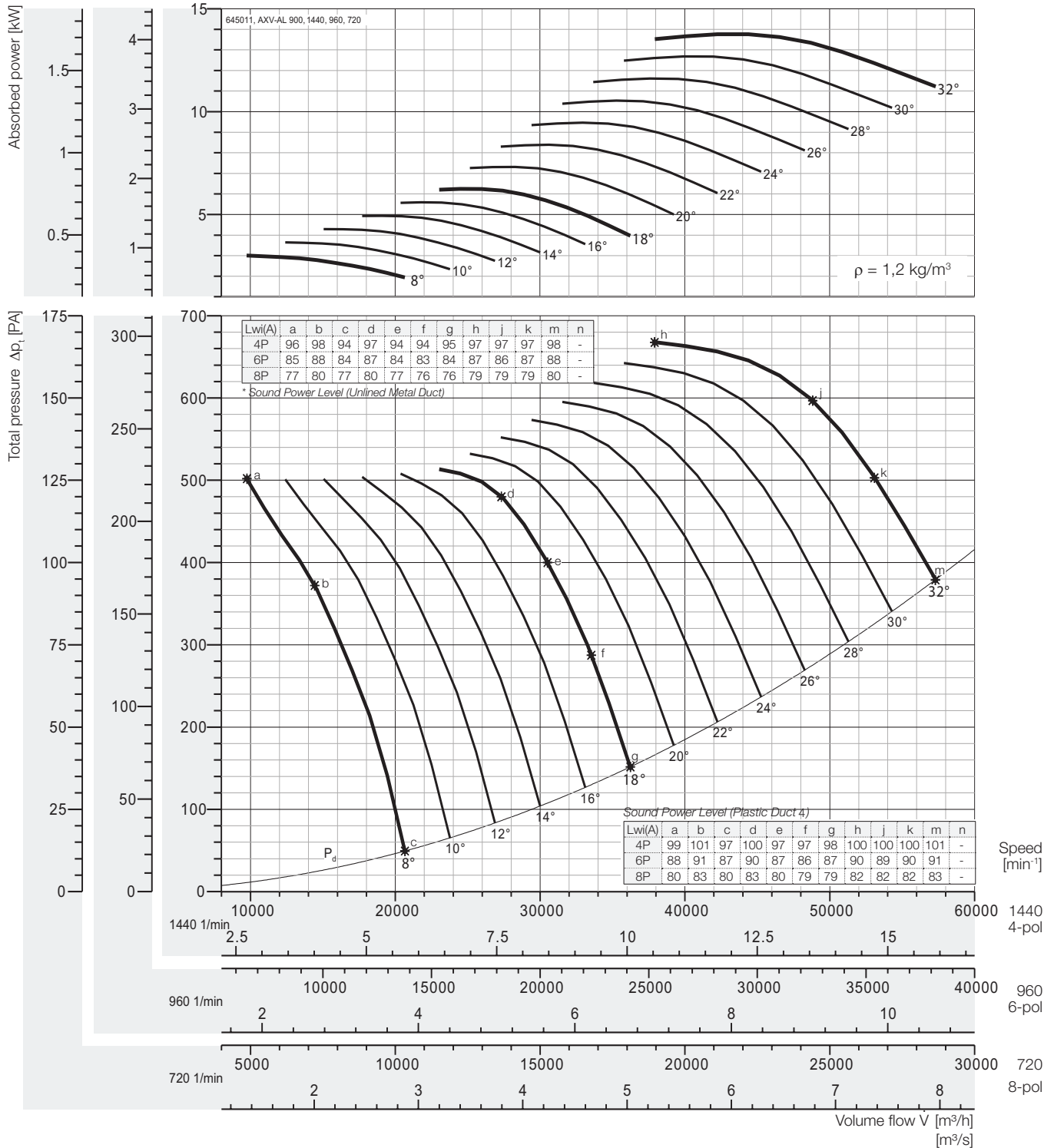

## Peak absorbed power [kW]

n [min <sup>-1</sup> ]	Pitch angle [°]																
	8	10	12	14	16	18	20	22	24	26	28	30	32	34	36	38	40
720 motor	0,376	0,456	0,536	0,617	0,699	0,780	0,914	1,05	1,18	1,32	1,45	1,59	1,72	-	-	-	-
960 motor	0,891	1,08	1,27	1,46	1,66	1,85	2,17	2,49	2,80	3,12	3,44	3,76	4,08	-	-	-	-
1440 motor	3,01	3,64	4,30	4,93	5,59	6,24	7,31	8,39	9,46	10,5	11,6	12,7	13,8	-	-	-	-

Fan test laboratory AMCA 210 Test Chamber. Performance certified is for installation type D - Ducted inlet, Ducted outlet. Performance ratings do not include the effects of appurtenances (accessories-belt cover, pulley & belt).

Dimensions + Accessories Page 191 - 194;  
Sound power frequency spectrum L<sub>w</sub> Page 196 - 200.

The A-weighted sound ratings shown have been calculated per AMCA International Standard 301. Values shown are for inlet Lw(A) sound power levels for installation Type D: ducted inlet, ducted outlet. Ratings include the effects of duct end correction.

\* Sound power level with unlined metal duct were obtained from the test in the reverberant room.  
Data are not licensed by AMCA.



# Performance Curve

AXV 1000-250-7, 50 Hz

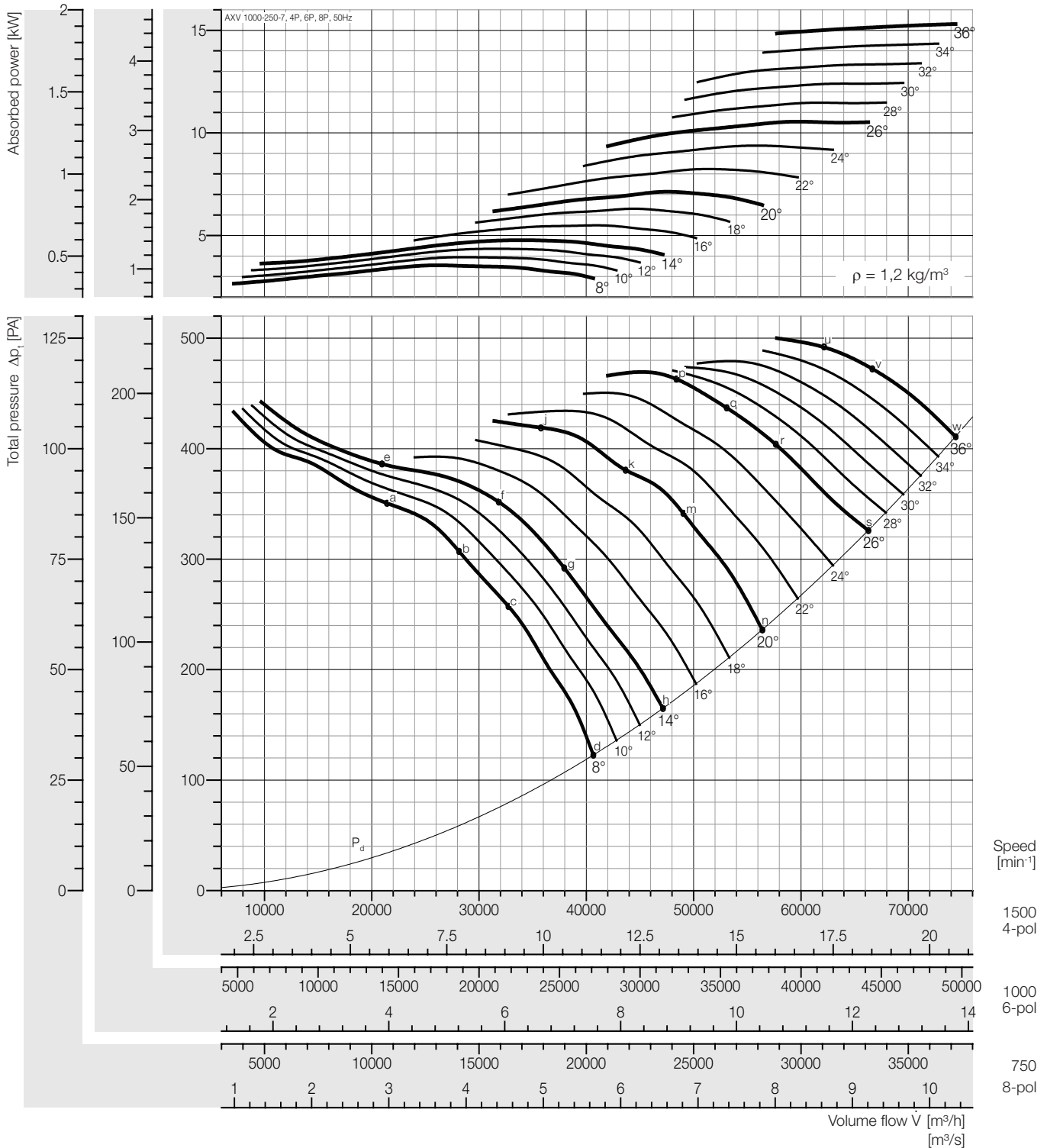

## Peak absorbed power [kW]

n [min <sup>-1</sup> ]	Pitch angle [°]														
	8	10	12	14	16	18	20	22	24	26	28	30	32	34	36
750	0,44	0,49	0,54	0,60	0,69	0,79	0,89	1,03	1,17	1,32	1,44	1,56	1,67	1,79	1,91
Motor	0,55		0,75		1,1		1,5		2,2						
1000	1,05	1,17	1,29	1,41	1,63	1,86	2,11	2,44	2,78	3,12	3,40	3,69	3,97	4,25	4,54
Motor	1,1	1,5		2,2		3,0		4,0		5,5					
1500	3,55	3,94	4,35	4,77	5,50	6,29	7,13	8,24	9,38	10,5	11,5	12,4	13,4	14,4	15,3
Motor	4,0	5,5		7,5		11		-							

## Sound power level, Lwi(A) [dB(A)]

Lwi(A)	a	b	c	d	e	f	g	h	j	k	m	n	p	q	r	s	t	u	v	w
4P	105	105	105	97	106	108	106	97	110	107	103	98	107	101	101	100	-	103	102	103
6P	94	95	95	88	95	97	96	88	99	97	93	89	97	92	92	90	-	92	92	93
8P	87	88	88	81	87	90	89	82	91	89	86	82	89	85	85	84	-	85	84	86

Plastic Duct

Lwi(A)	a	b	c	d	e	f	g	h	j	k	m	n	p	q	r	s	t	u	v	w
4P	103	103	103	95	104	106	104	95	108	105	101	96	105	99	99	98	-	101	100	101
6P	92	93	93	86	93	95	94	86	97	95	91	87	95	90	90	88	-	90	90	91
8P	85	86	86	79	85	88	87	80	89	87	84	80	87	83	83	82	-	83	82	84

\* Unlined Metal Duct

The A-weighted sound ratings shown have been calculated per AMCA International Standard 301. Values shown are for inlet LwiA sound power levels for installation Type D: ducted inlet, ducted outlet. Ratings include the effects of duct end correction.

\* Sound power level with unlined metal duct were obtained from the test in the reverberant room. Data are not licensed by AMCA.

Fan test laboratory AMCA 210 Test Chamber. Performance certified is for installation type D - Ducted inlet, Ducted outlet. Performance ratings do not include the effects of appurtenances (accessories-belt cover, pulley & belt).

Dimensions + Accessories Page 191 - 194;

Sound power frequency spectrum L<sub>w</sub> Page 196 - 200.



# Performance Curve

AXV 1000-250-14, 50 Hz

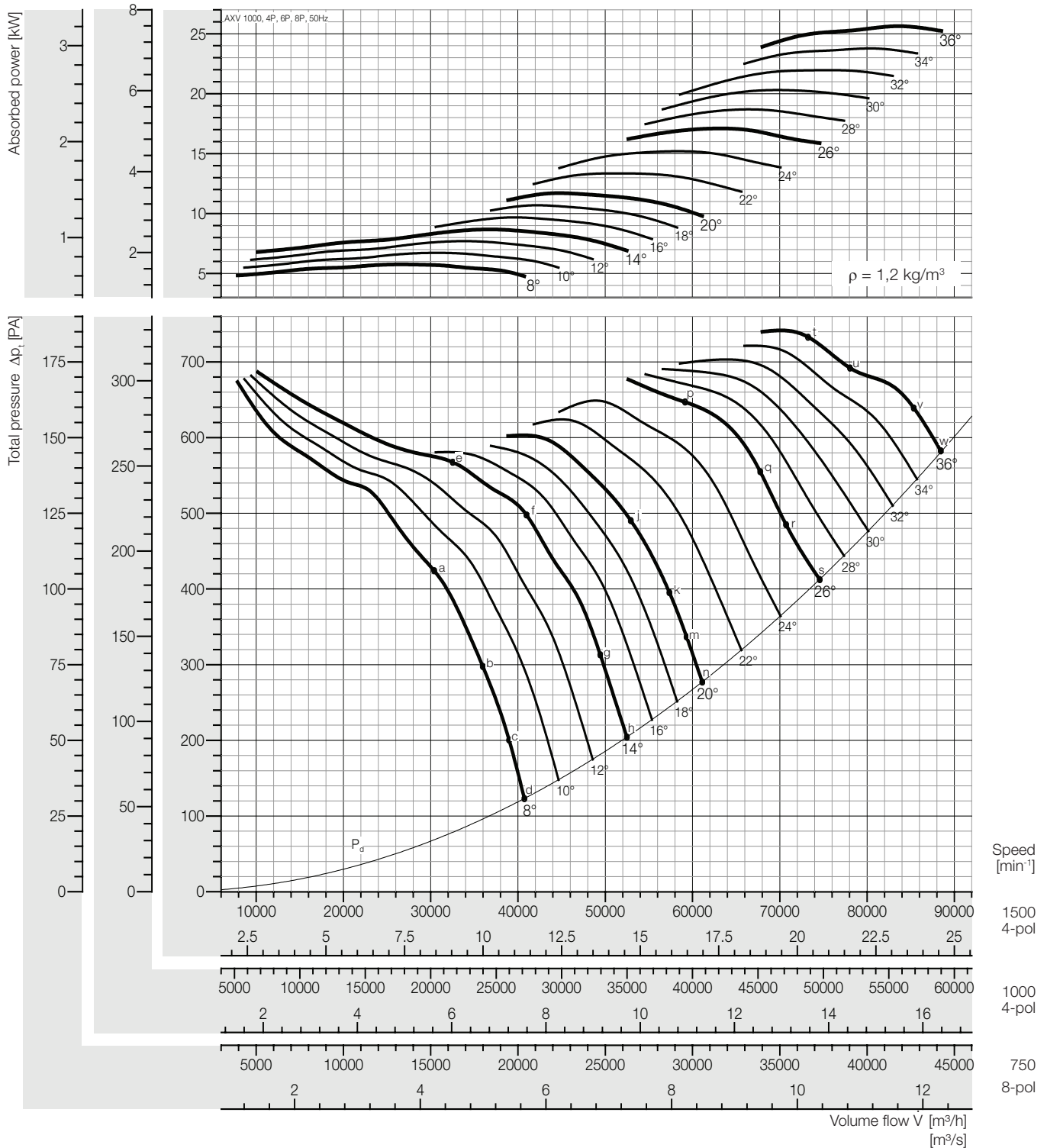

### Peak absorbed power [kW]

n [min <sup>-1</sup> ]	Pitch angle [°]														
	8	10	12	14	16	18	20	22	24	26	28	30	32	34	36
750	0,72	0,84	0,96	1,08	1,21	1,34	1,46	1,67	1,90	2,14	2,34	2,54	2,75	2,97	3,20
Motor	0,75	1,1			1,5			2,2			3,0				4,0
1000	1,71	1,99	2,27	2,56	2,87	3,17	3,46	3,96	4,50	5,07	5,54	6,02	6,51	7,04	7,59
Motor	2,2		3,0			4,0		5,5		7,5					11
1500	5,76	6,70	7,67	8,65	9,67	10,7	11,7	13,4	15,2	17,1	18,7	20,3	22,0	23,8	25,6
Motor	7,5		11												

### Sound power level, Lwi(A) [dB(A)]

Lwi(A)	a	b	c	d	e	f	g	h	j	k	m	n	p	q	r	s	t	u	v	w
4P	108	107	102	101	108	110	102	100	107	103	101	101	110	104	103	102	107	105	105	105
6P	98	97	93	92	98	100	92	91	97	93	92	92	100	94	93	93	97	95	95	95
8P	91	90	86	86	90	92	85	84	90	86	85	85	92	87	86	86	89	88	87	88

Plastic Duct

Lwi(A)	a	b	c	d	e	f	g	h	j	k	m	n	p	q	r	s	t	u	v	w
4P	106	105	100	99	106	108	100	98	105	101	99	99	108	102	101	100	105	103	103	103
6P	96	95	91	90	96	98	90	89	95	95	90	90	98	92	91	91	95	93	93	93
8P	89	88	84	84	88	90	83	82	88	84	83	83	90	85	84	84	87	86	85	86

\* Unlined Metal Duct

Fan test laboratory AMCA 210 Test Chamber. Performance certified is for installation type D - Ducted inlet, Ducted outlet. Performance ratings do not include the effects of appurtenances (accessories-belt cover, pulley & belt).

Dimensions + Accessories Page 191 - 194;  
Sound power frequency spectrum L<sub>wnd</sub> Page 196 - 200.

The A-weighted sound ratings shown have been calculated per AMCA International Standard 301. Values shown are for inlet LwiA sound power levels for installation Type D: ducted inlet, ducted outlet. Ratings include the effects of duct end correction.

\* Sound power level with unlined metal duct were obtained from the test in the reverberant room. Data are not licensed by AMCA.



# Performance Curve

AXV 1000-300-10, 50 Hz

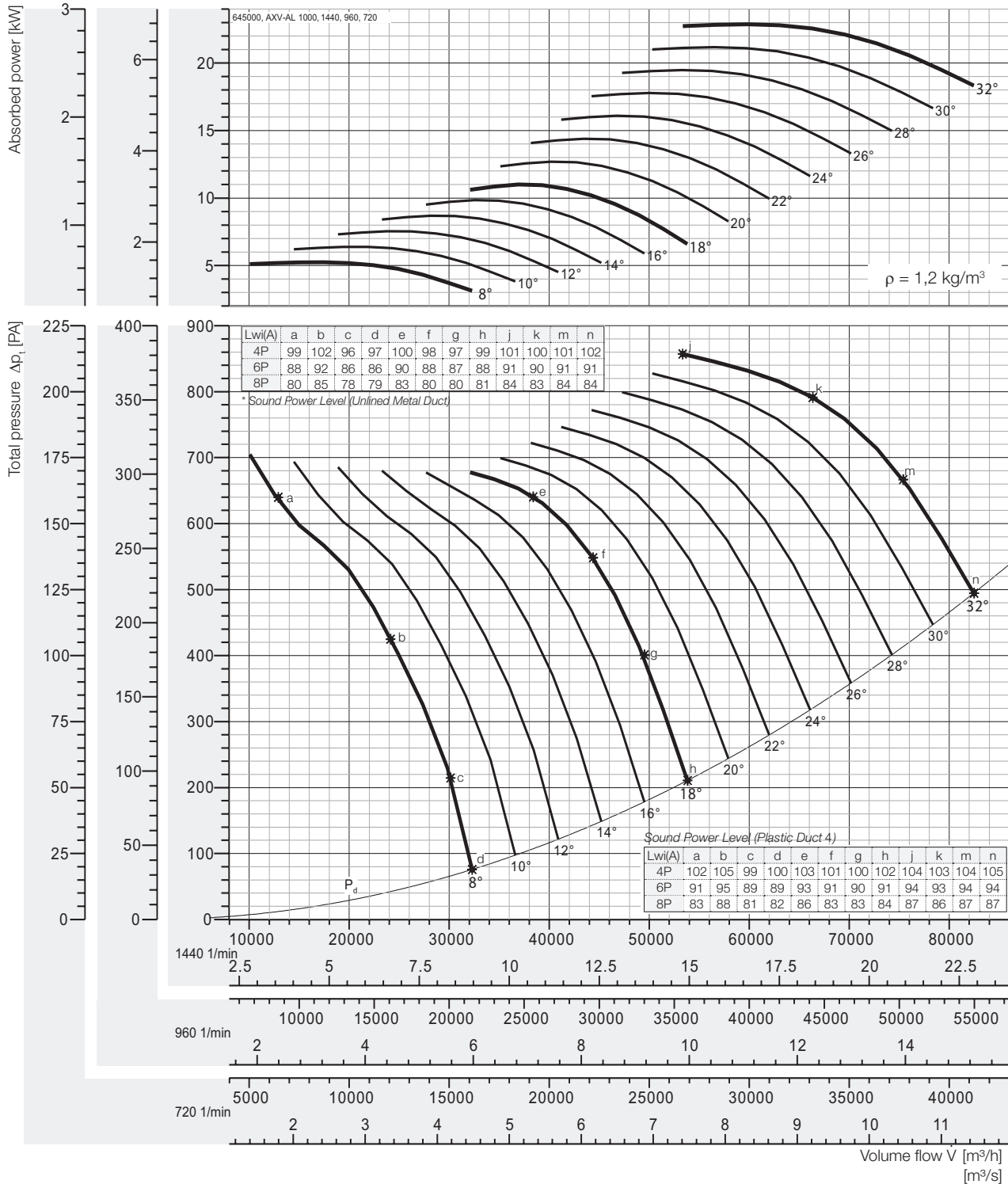

## Peak absorbed power [kW]

n [min <sup>-1</sup> ]	Pitch angle [°]																
	8	10	12	14	16	18	20	22	24	26	28	30	32	34	36	38	40
720 motor	0,654	0,798	0,942	1,09	1,23	1,38	1,59	1,80	2,01	2,22	2,44	2,65	2,86	-	-	-	-
960 motor	1,55	1,89	2,23	2,58	2,92	3,26	3,76	4,26	4,77	5,27	5,77	6,27	6,78	-	-	-	-
1440 motor	5,23	6,38	7,54	8,69	9,85	11,0	12,7	14,4	16,1	17,8	19,5	21,2	22,9	-	-	-	-

Fan test laboratory AMCA 210 Test Chamber. Performance certified is for installation type D - Ducted inlet, Ducted outlet. Performance ratings do not include the effects of appurtenances (accessories-belt cover, pulley & belt).

Dimensions + Accessories Page 191 - 194;  
Sound power frequency spectrum L<sub>w</sub> Page 196 - 200.

The A-weighted sound ratings shown have been calculated per AMCA International Standard 301. Values shown are for inlet Lw(A) sound power levels for installation Type D: ducted inlet, ducted outlet. Ratings include the effects of duct end correction.

\* Sound power level with unlined metal duct were obtained from the test in the reverberant room.  
Data are not licensed by AMCA.



# Performance Curve

AXV 1120-300-5, 50 Hz

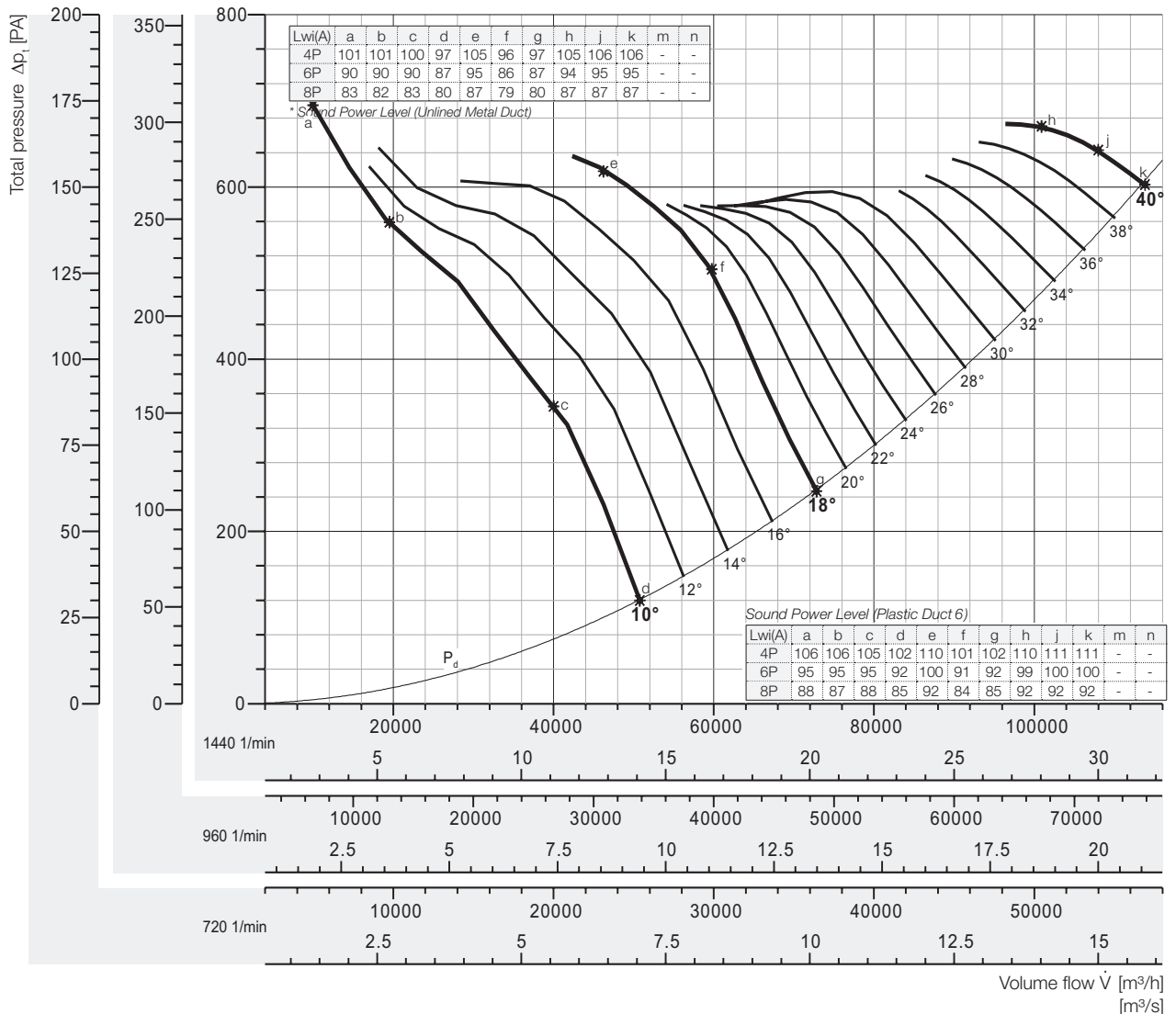
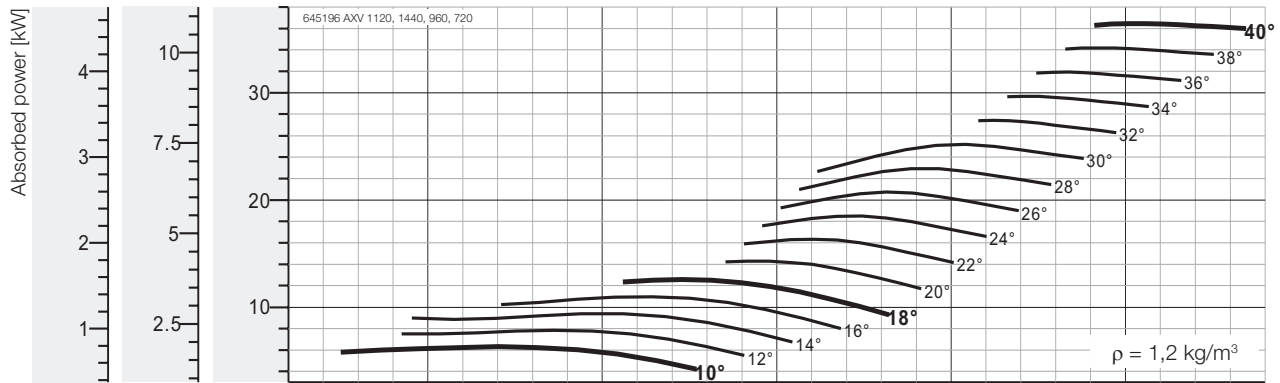

## Peak absorbed power [kW]

n [min <sup>-1</sup> ]	Pitch angle [°]																
	8	10	12	14	16	18	20	22	24	26	28	30	32	34	36	38	40
720 motor	-	0,789	0,98	1,17	1,37	1,57	1,78	2,04	2,32	2,59	2,87	3,15	3,43	3,71	3,99	4,27	4,56
		1,1		1,5		2,2		3		4		5,5					
960 motor	-	1,87	2,32	2,78	3,25	3,73	4,23	4,85	5,49	6,14	6,79	7,46	8,13	8,79	9,46	10,1	10,8
		2,2	3		4		5,5		7,5		11						
1440 motor	-	6,31	7,85	9,39	11,0	12,6	14,3	16,4	18,5	20,7	22,9	25,2	27,4	29,7	31,9	34,2	36,4
		7,5	11		15		18,5		22	30		37					

Fan test laboratory AMCA 210 Test Chamber. Performance certified is for installation type D - Ducted inlet, Ducted outlet. Performance ratings do not include the effects of appearances (accessories-belt cover, pulley & belt).

Dimensions + Accessories Page 191 - 194;  
Sound power frequency spectrum L<sub>w</sub> Page 196 - 200.

The A-weighted sound ratings shown have been calculated per AMCA International Standard 301. Values shown are for inlet Lw(A) sound power levels for installation Type D: ducted inlet, ducted outlet. Ratings include the effects of duct end correction.

\* Sound power level with unlined metal duct were obtained from the test in the reverberant room. Data are not licensed by AMCA.





# Performance Curve

AXV 1250-370-6, 50 Hz

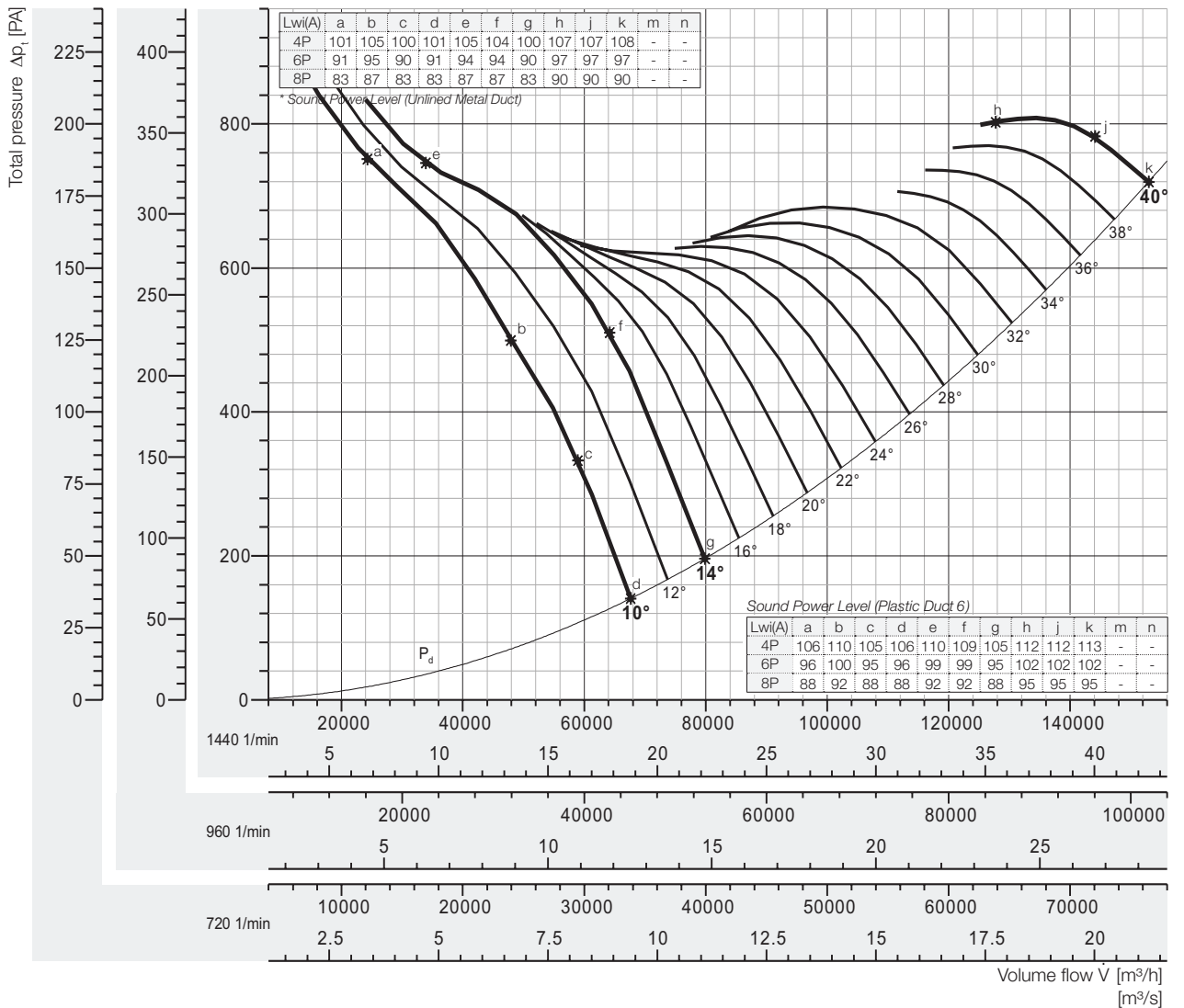
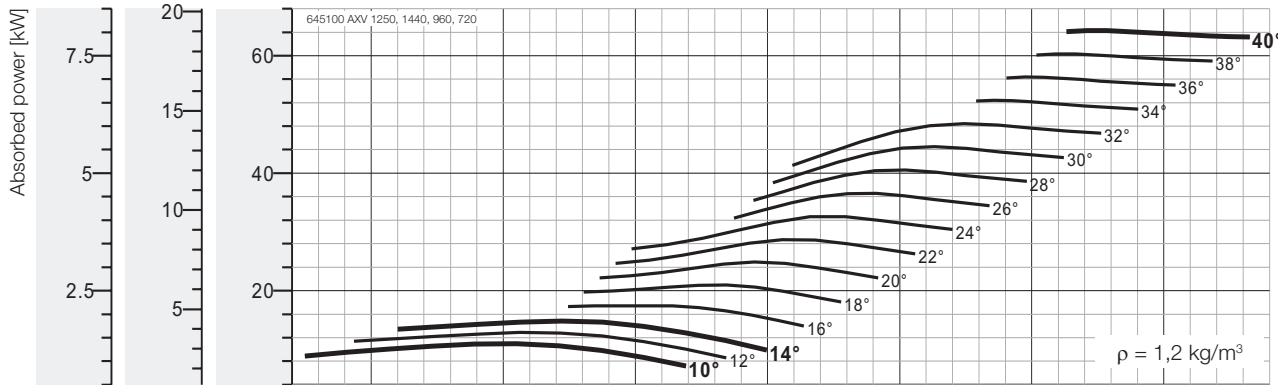

## Peak absorbed power [kW]

n [min <sup>-1</sup> ]	Pitch angle [°]																
	8	10	12	14	16	18	20	22	24	26	28	30	32	34	36	38	40
720 motor	-	1,38	1,61	1,86	2,18	2,63	3,11	3,59	4,08	4,57	5,07	5,57	6,06	6,55	7,05	7,54	8,03
960 motor	-	3,26	3,82	4,40	5,17	6,23	7,37	8,51	9,66	10,8	12,0	13,2	14,4	15,5	16,7	17,9	19,0
1440 motor	-	11,0	12,9	14,8	17,5	21,0	24,9	28,7	32,6	36,6	40,6	44,5	48,5	52,4	56,4	60,3	64,3

Fan test laboratory AMCA 210 Test Chamber. Performance certified is for installation type D - Ducted inlet, Ducted outlet. Performance ratings do not include the effects of appurtenances (accessories-belt cover, pulley & belt).  
 Dimensions + Accessories Page 191 ~ 194;  
 Sound power frequency spectrum L<sub>w</sub> Page 196 ~ 200.

The A-weighted sound ratings shown have been calculated per AMCA International Standard 301. Values shown are for inlet Lw<sub>i</sub> sound power levels for installation Type D: ducted inlet, ducted outlet. Ratings include the effects of duct end correction.  
 \* Sound power level with unlined metal duct were obtained from the test in the reverberant room.  
 Data are not licensed by AMCA.



# Performance Curve

AXV 1400-420-6, 50 Hz

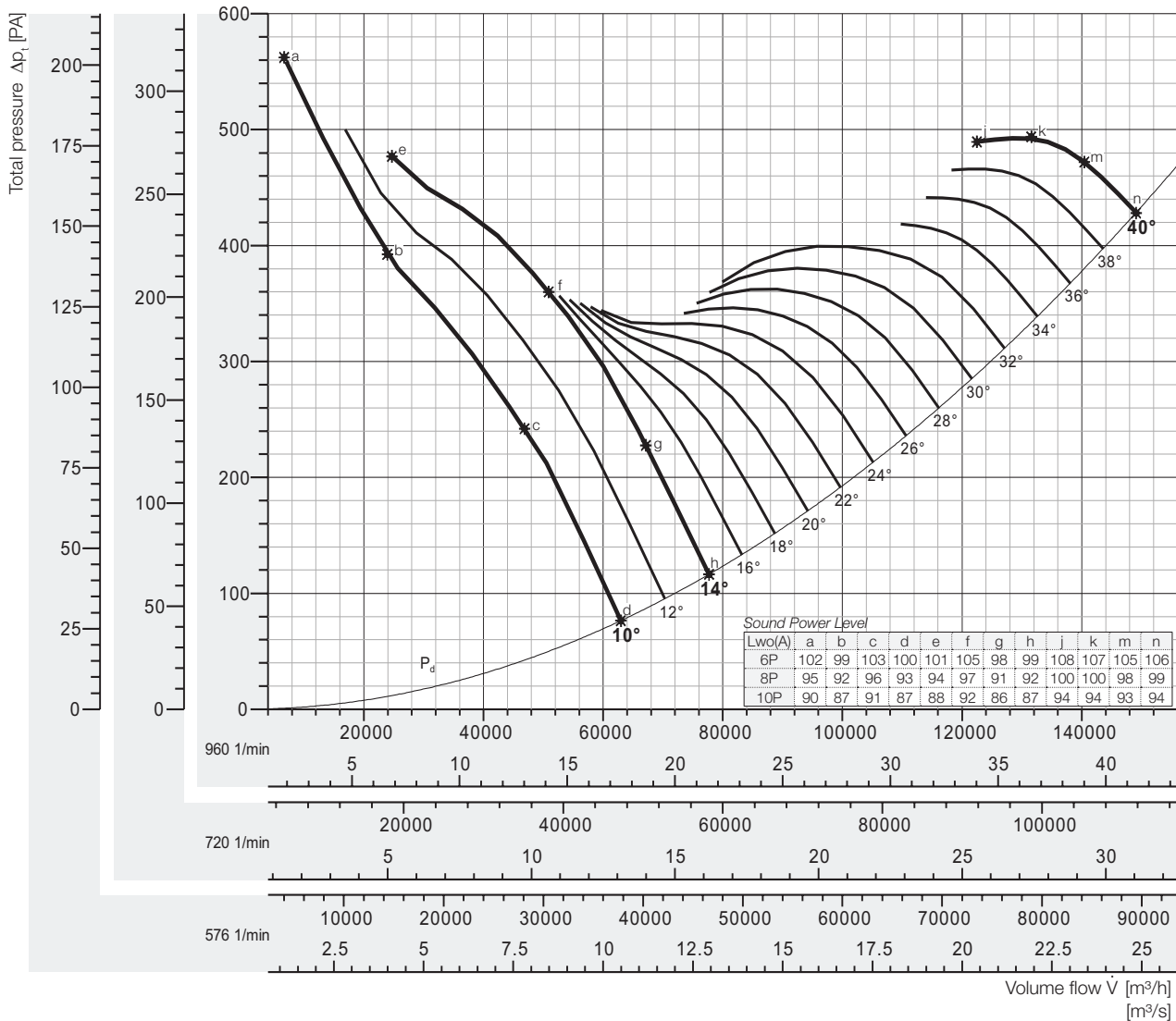
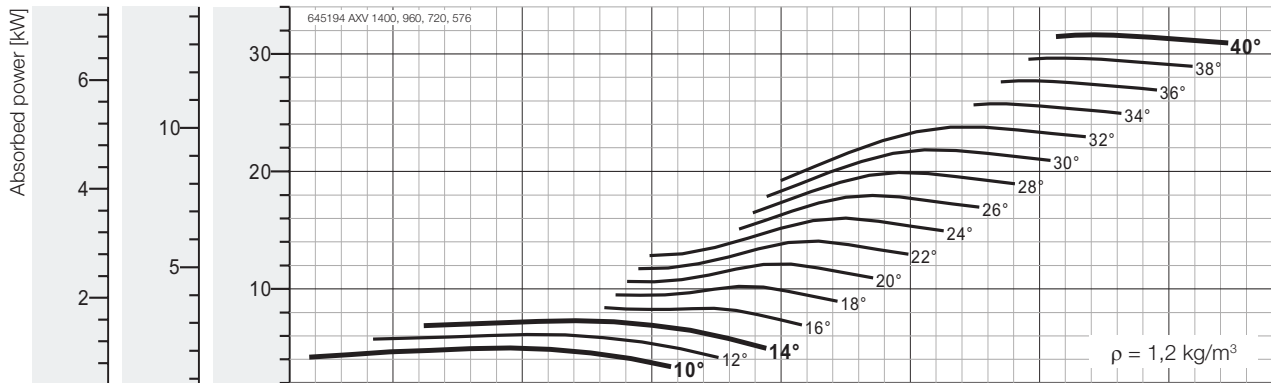

Speed [min<sup>-1</sup>]  
 960 6-pol  
 720 8-pol  
 576 10-pol

## Peak absorbed power [kW]

n [min <sup>-1</sup> ]	Pitch angle [°]																
	8	10	12	14	16	18	20	22	24	26	28	30	32	34	36	38	40
576 motor	-	1,08	1,33	1,58	1,81	2,20	2,62	3,04	3,46	3,88	4,30	4,72	5,13	5,56	5,98	6,41	6,83
720 motor	-	2,10	2,59	3,09	3,54	4,31	5,11	5,94	6,76	7,58	8,40	9,21	10,0	10,9	11,7	12,5	13,3
960 motor	-	4,98	6,14	7,32	8,40	10,2	12,1	14,1	16,0	18,0	19,9	21,8	23,8	25,7	27,7	29,7	31,6

Fan test laboratory AMCA 210 Test Chamber. Performance certified is for installation type A - Free inlet, free outlet. Performance ratings do not include the effects of appurtenances (accessories-belt cover, pulley & belt).

Dimensions + Accessories Page 191 - 194;  
 Sound power frequency spectrum L<sub>w</sub> Page 196 - 200.

The A-weighted sound ratings shown have been calculated per AMCA International Standard 301. Values shown are for outlet LwoA sound power levels for installation (type A: free inlet, free outlet).



# Performance Curve

AXV 1600-420-6, 50 Hz

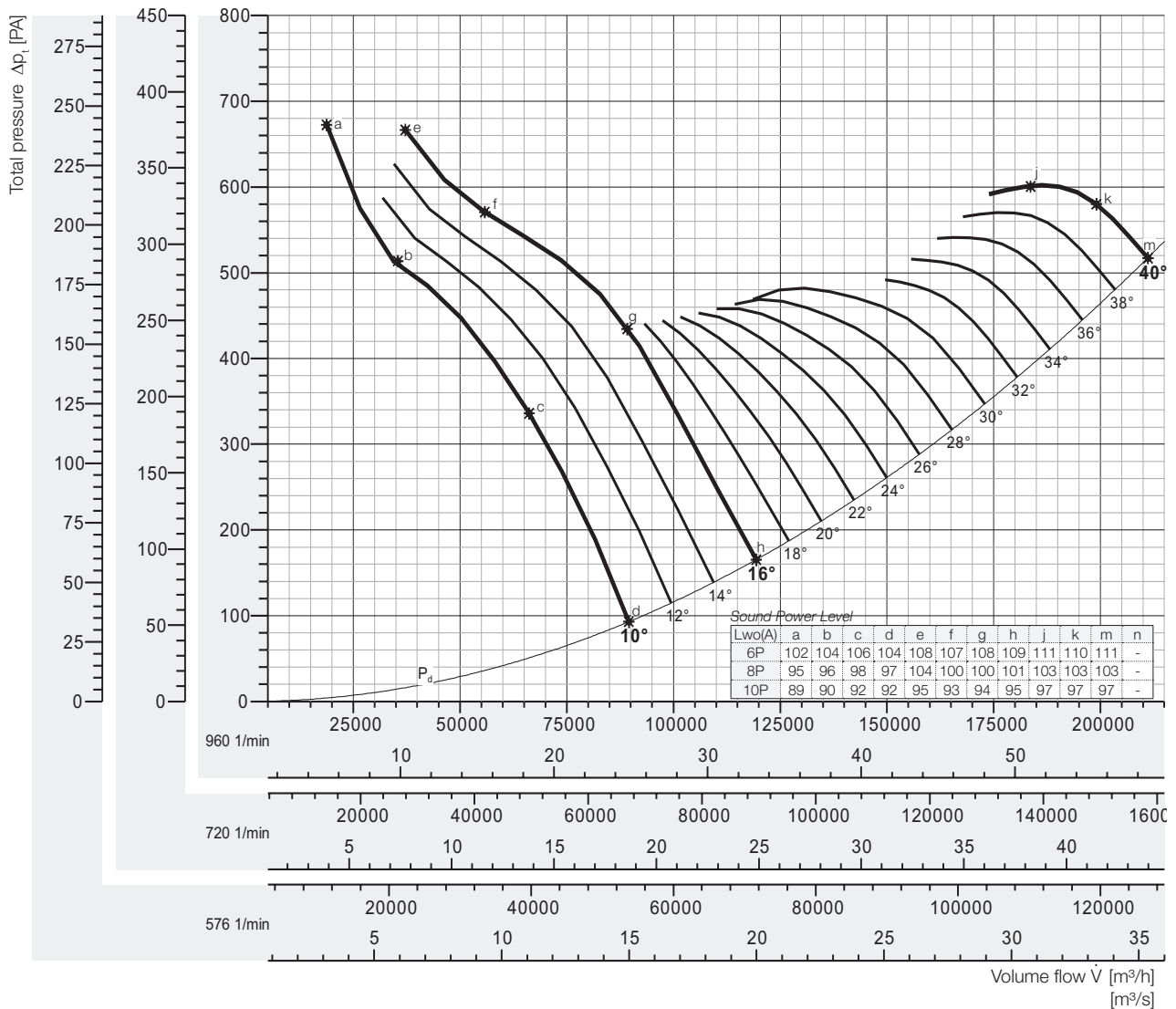
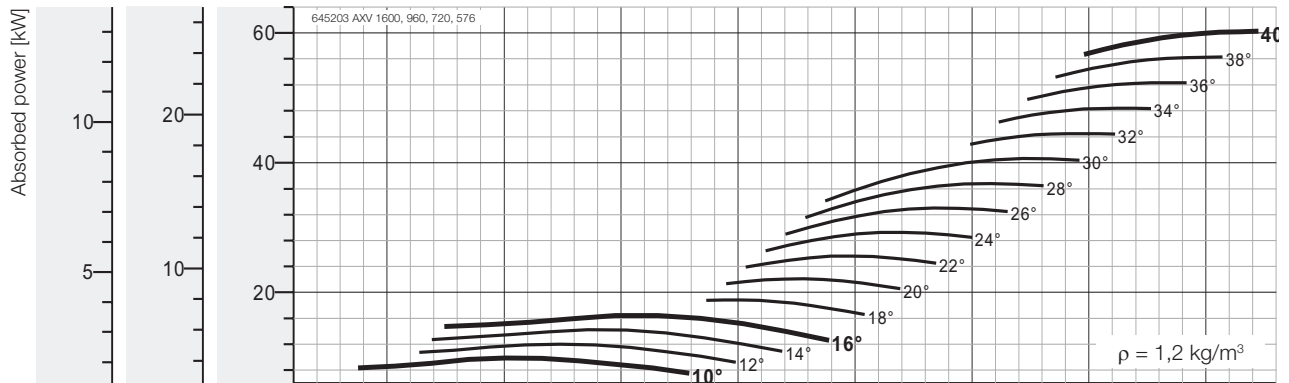

## Peak absorbed power [kW]

n [min <sup>-1</sup> ]	Pitch angle [°]																
	8	10	12	14	16	18	20	22	24	26	28	30	32	34	36	38	40
576 motor	-	2,13	2,60	3,07	3,55	4,07	4,77	5,53	6,32	7,13	7,95	8,78	9,61	10,5	11,3	12,1	13,0
		2,2	3	4		5,5		7,5			11			15			
720 motor	-	4,16	5,08	6,00	6,94	7,94	9,32	10,8	12,3	13,9	15,5	17,1	18,8	20,4	22,0	23,8	25,4
		5,5		7,5		11		15		18,5		22		30			
960 motor	-	9,86	12,0	14,2	16,4	18,8	22,0	25,6	29,3	33,0	36,8	40,6	44,5	48,4	52,3	56,3	60,3
		11	15		18,5	22		30		37		45		55		75	

Fan test laboratory AMCA 210 Test Chamber. Performance certified is for installation type A - Free inlet, Free outlet. Performance ratings do not include the effects of appurtenances (accessories-belt cover, pulley & belt).

The A-weighted sound ratings shown have been calculated per AMCA International Standard 301. Values shown are for outlet LwoA sound power levels for installation Type A: free inlet, free outlet.

Dimensions + Accessories Page 191 - 194;  
Sound power frequency spectrum L<sub>max</sub> Page 196 - 200.



# Performance Curve

AXV 1800-540-6, 50 Hz

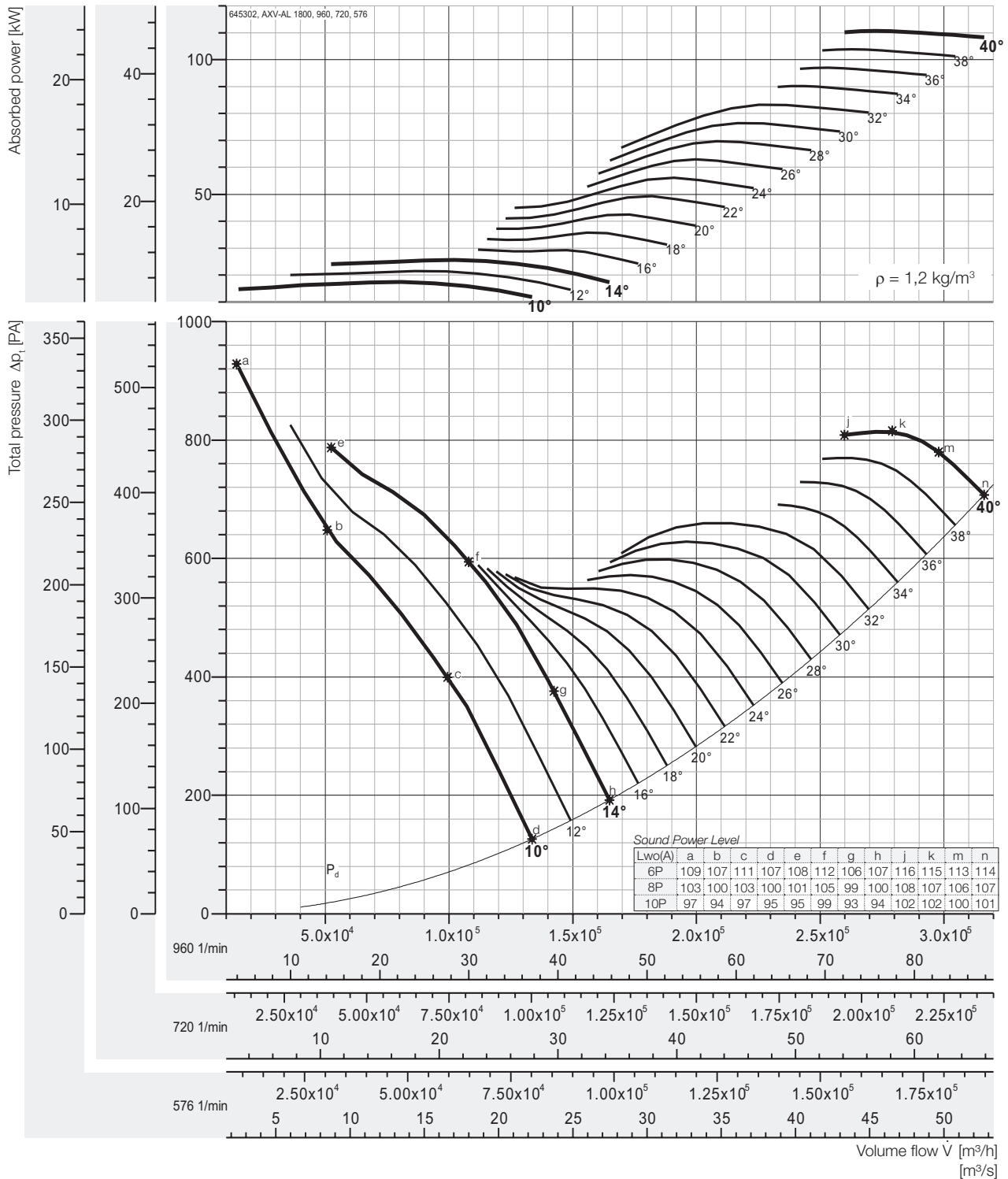

## Peak absorbed power [kW]

n [min <sup>-1</sup> ]	Pitch angle [°]																
	8	10	12	14	16	18	20	22	24	26	28	30	32	34	36	38	40
576 motor	-	3,76	4,64	5,54	6,36	7,73	9,17	10,6	12,1	13,6	15,0	16,5	18,0	19,5	20,9	22,4	23,9
		4	5,5	7,5		11			15			18,5		22		30	
720 motor	-	7,35	9,07	10,8	12,4	15,0	17,9	20,8	23,7	26,6	29,4	32,3	35,1	38,0	40,9	43,8	46,7
		7,5	11		15		18,5	22	30			37		45		55	
960 motor	-	17,4	21,5	25,6	29,4	35,8	42,4	49,3	56,1	62,9	69,7	76,5	83,2	90,2	97,0	103,8	110,7
		18,5	22	30		37	45	55	75			90		110		132	

Fan test laboratory AMCA 210 Test Chamber. Performance certified is for installation type A - Free inlet, Free outlet. Performance ratings do not include the effects of appurtenances (accessories-belt cover, pulley & belt).

Dimensions + Accessories Page 191 - 194;  
Sound power frequency spectrum L<sub>w</sub> Page 196 - 200.

The A-weighted sound ratings shown have been calculated per AMCA International Standard 301. Values shown are for outlet L<sub>wo</sub>A sound power levels for installation type A: free inlet, free outlet.



# Performance Curve

AXV 2000-600-6, 50 Hz

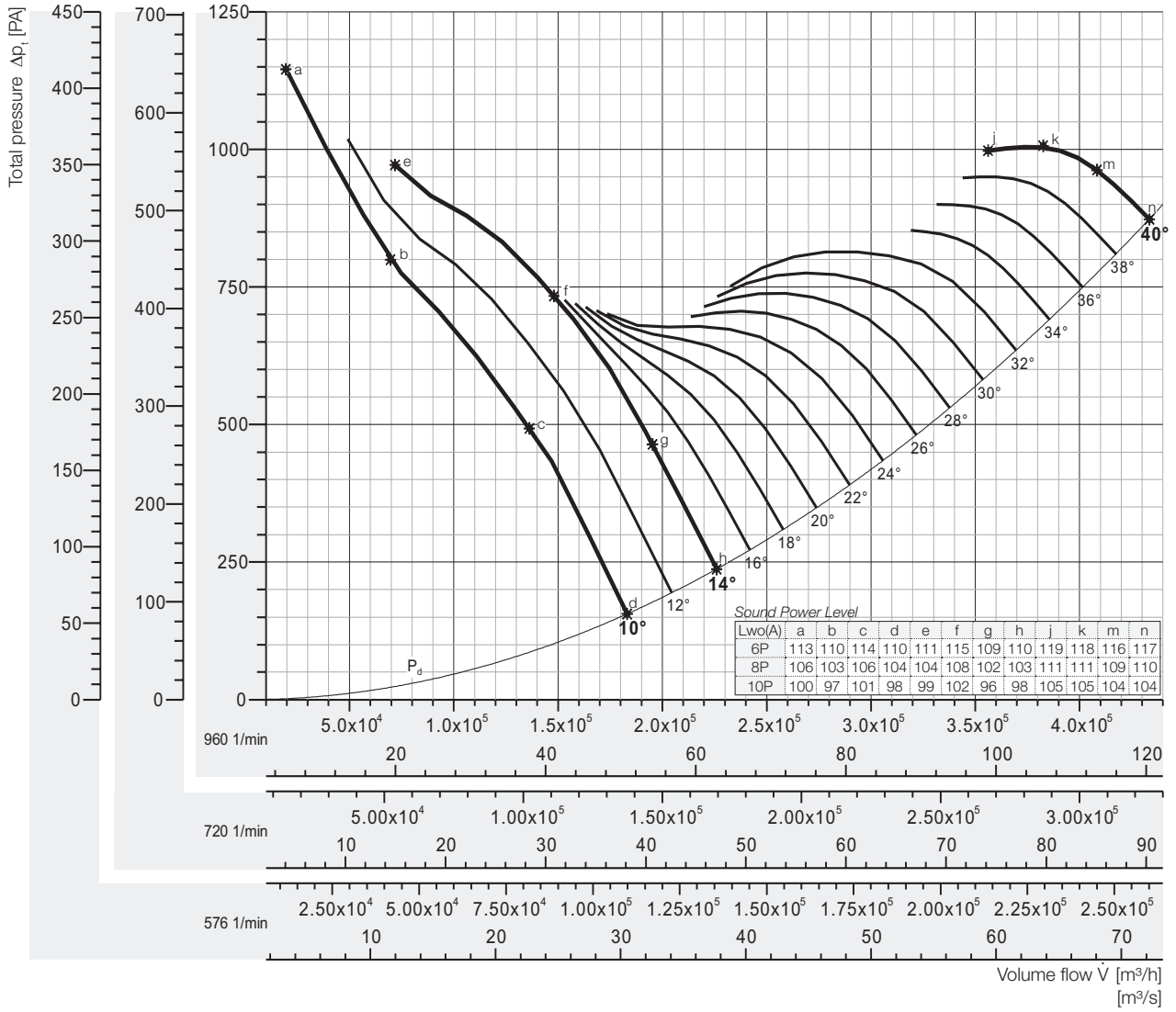
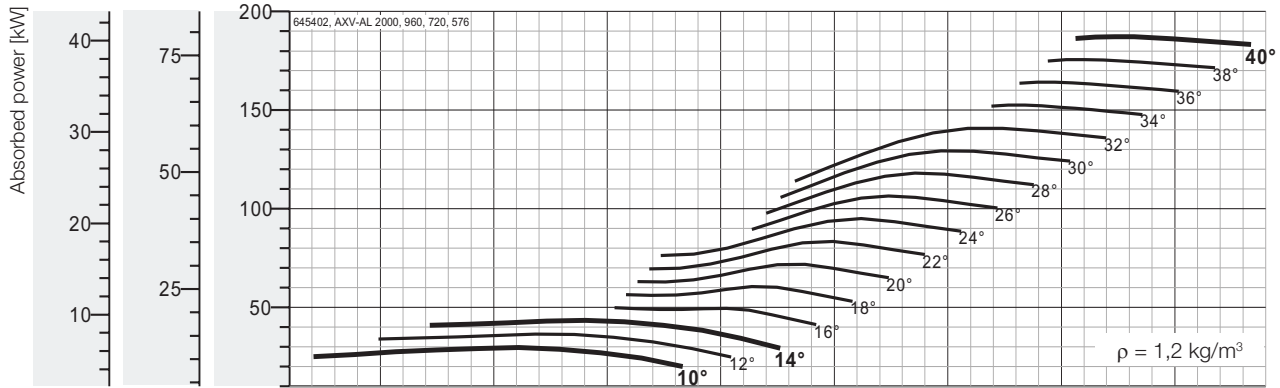

## Peak absorbed power [kW]

n [min <sup>-1</sup> ]	Pitch angle [°]																
	8	10	12	14	16	18	20	22	24	26	28	30	32	34	36	38	40
576 motor	-	6,37	7,85	9,36	10,7	13,1	15,5	18,0	20,5	23,0	25,5	27,9	30,4	32,9	35,4	37,9	40,4
		7,5	11			15	18,5		22	30			37			45	
720 motor	-	12,4	15,3	18,3	21,0	25,5	30,3	35,2	40,0	44,9	49,8	54,6	59,4	64,4	69,2	74,1	79,0
		15	18,5		22	30	37		45	55		75				90	
960 motor	-	29,5	36,3	43,3	49,8	60,5	71,8	83,4	94,9	106,4	117,9	129,4	140,8	152,5	164,1	175,7	187,3
		30	37	45	55	75		90	110	132		160		200			

Fan test laboratory AMCA 210 Test Chamber. Performance certified is for installation type A - Free inlet, Free outlet. Performance ratings do not include the effects of appurtenances (accessories-belt cover, pulley & belt).  
 Dimensions + Accessories Page 191 - 194;  
 Sound power frequency spectrum L<sub>max</sub> Page 196 - 200.

The A-weighted sound ratings shown have been calculated per AMCA International Standard 301. Values shown are for outlet LwoA sound power levels for installation Type A: free inlet, free outlet.



# Performance Curve

AXV 2200-660-6, 50 Hz

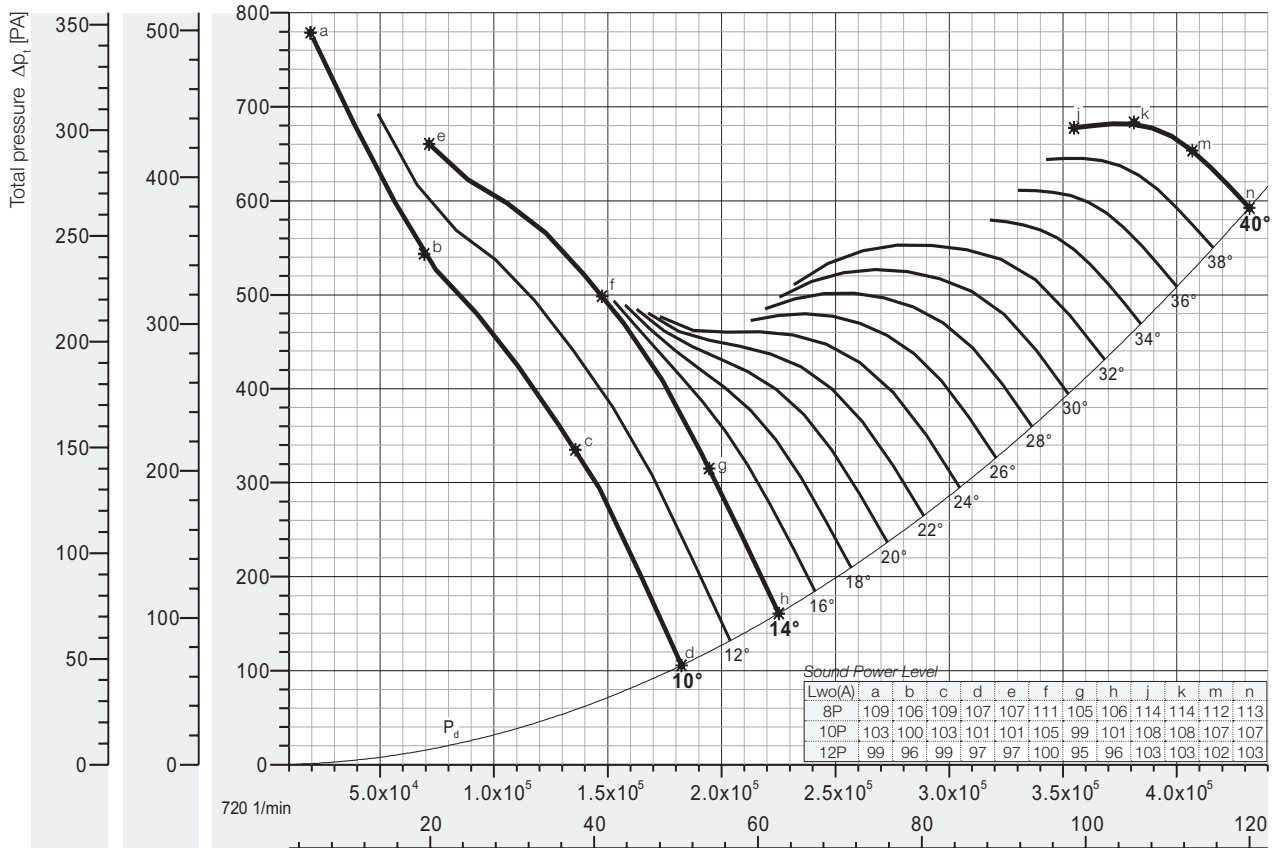
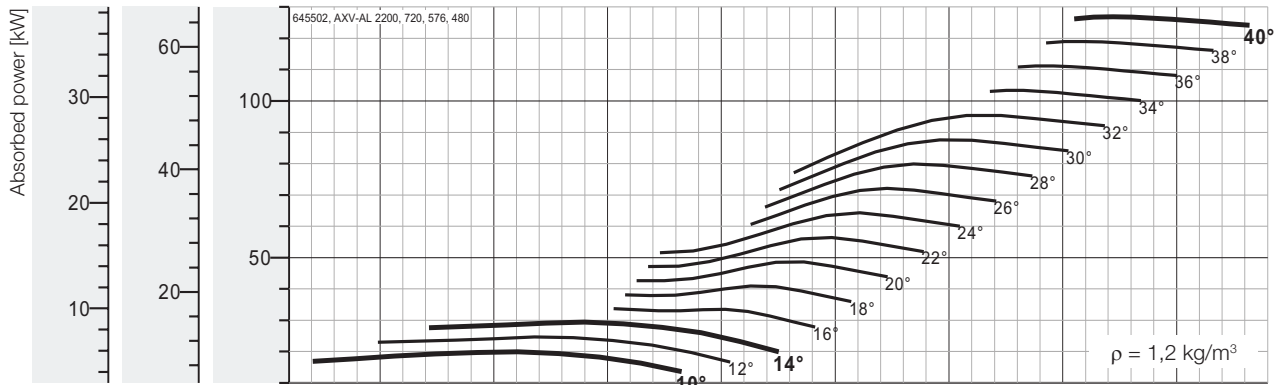

Speed [min<sup>-1</sup>]  
720  
8-pol  
576  
10-pol  
480  
12-pol

Volume flow  $\dot{V}$  [m³/h]  
[m³/s]

## Peak absorbed power [kW]

n [min <sup>-1</sup> ]	Pitch angle [°]																
	8	10	12	14	16	18	20	22	24	26	28	30	32	34	36	38	40
480 motor	-	5,92	7,30	8,70	9,99	12,1	14,4	16,7	19,1	21,4	23,7	26,0	28,3	30,6	32,9	35,3	37,6
		7,5		11		15		18,5	22		30		37		45		
576 motor	-	10,2	12,6	15,0	17,3	21,0	24,9	28,9	32,9	36,9	40,9	44,9	48,8	52,9	56,9	60,9	64,9
		11	15		18,5	22	30		37		45		55		75		
720 motor	-	20,0	24,6	29,4	33,7	41,0	48,6	56,5	64,3	72,1	79,9	87,6	95,4	103,3	111,1	119,0	126,8
		22	30		37	45	55	75		90		110		132			

Fan test laboratory AMCA 210 Test Chamber. Performance certified is for installation type A - Free inlet, free outlet. Performance ratings do not include the effects of appurtenances (accessories-belt cover, pulley & belt).

Dimensions + Accessories Page 191 - 194;  
Sound power frequency spectrum L<sub>w</sub> Page 196 - 200.

The A-weighted sound ratings shown have been calculated per AMCA International Standard 301. Values shown are for outlet L<sub>wo</sub>A sound power levels for installation type A: free inlet, free outlet.



# Performance Curve

AXV 2400-720-6, 50 Hz

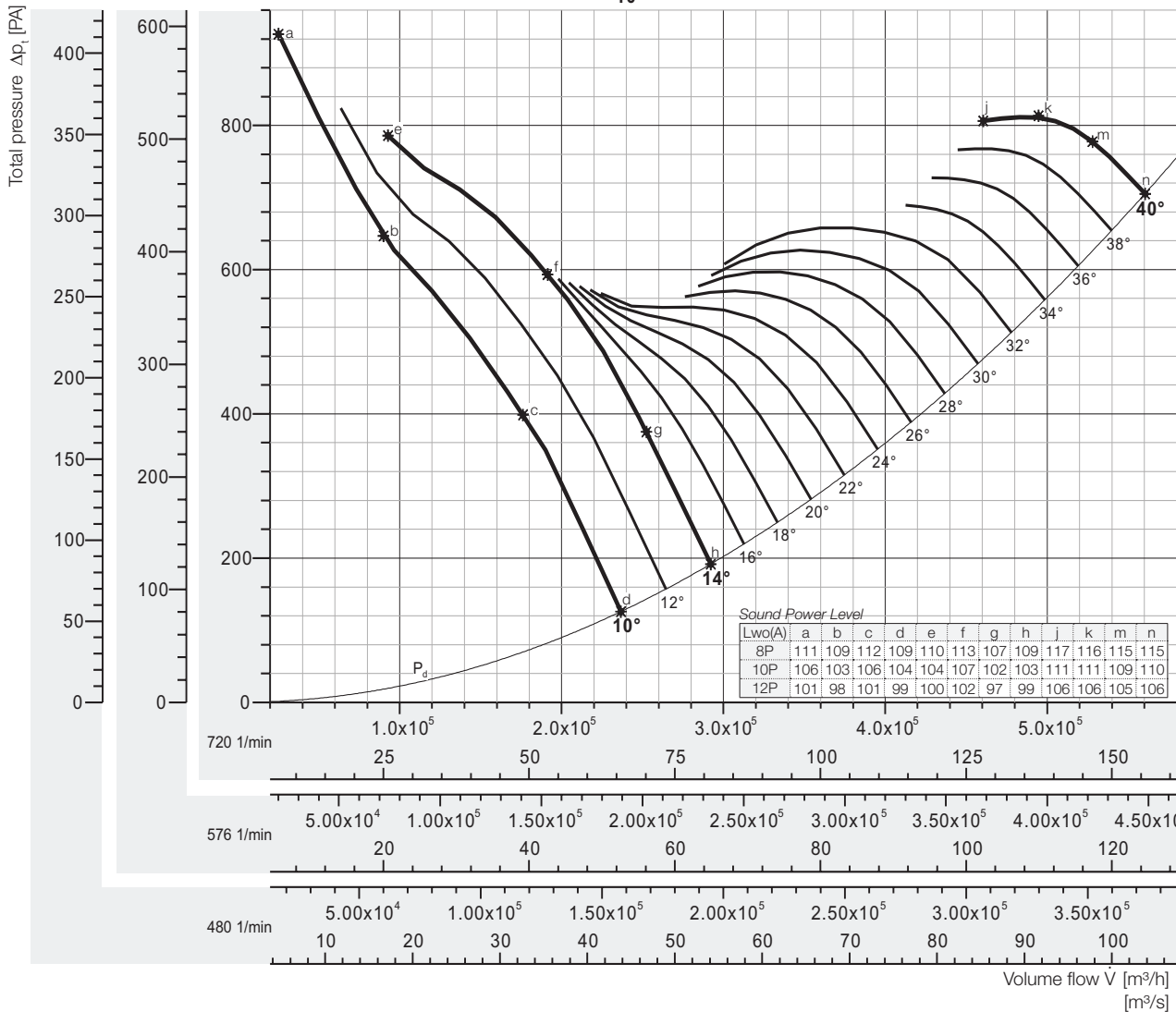
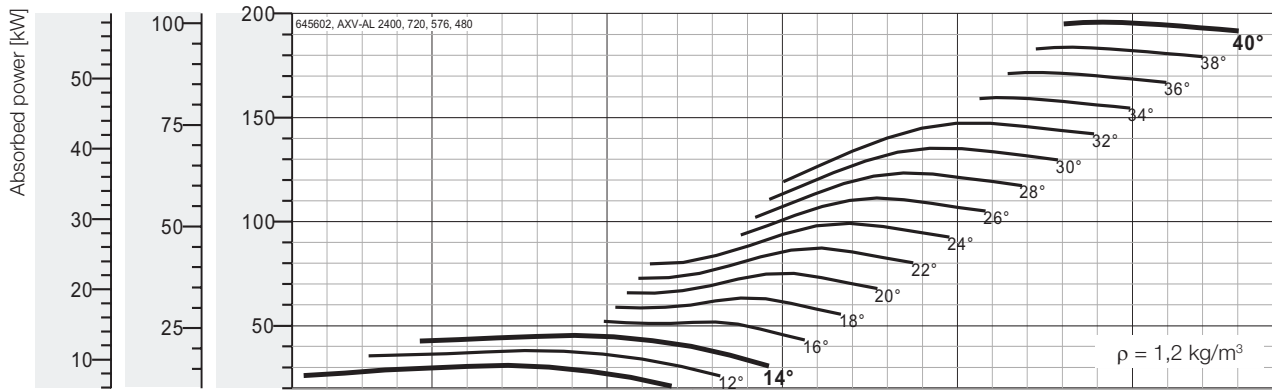

## Peak absorbed power [kW]

n [min <sup>-1</sup> ]	Pitch angle [°]																
	8	10	12	14	16	18	20	22	24	26	28	30	32	34	36	38	40
480 motor	-	9,14	11,3	13,4	15,4	18,7	22,2	25,8	29,4	33,0	36,5	40,1	43,6	47,3	50,9	54,4	58,0
		11	15		18,5	22	30		37		45		55				75
576 motor	-	15,8	19,5	23,2	26,7	32,4	38,4	44,6	50,8	57,0	63,2	69,3	75,4	81,7	87,9	94,1	100,3
		18,5	22	30		37	55		75			90				110	
720 motor	-	30,8	38,0	45,3	52,1	63,3	75,0	87,2	99,3	111,3	123,3	135,3	147,3	159,5	171,6	183,7	195,8
		37	45	55		75		90	110	132		160			200		

Fan test laboratory AMCA 210 Test Chamber. Performance certified is for installation type A - Free inlet, Free outlet. Performance ratings do not include the effects of appurtenances (accessories-belt cover, pulley & belt).

The A-weighted sound ratings shown have been calculated per AMCA International Standard 301. Values shown are for outlet LwoA sound power levels for installation Type A: free inlet, free outlet.

Dimensions + Accessories Page 191 - 194;  
Sound power frequency spectrum L<sub>max</sub> Page 196 - 200.



# Performance Curve

AXV 2500-750-6, 50 Hz

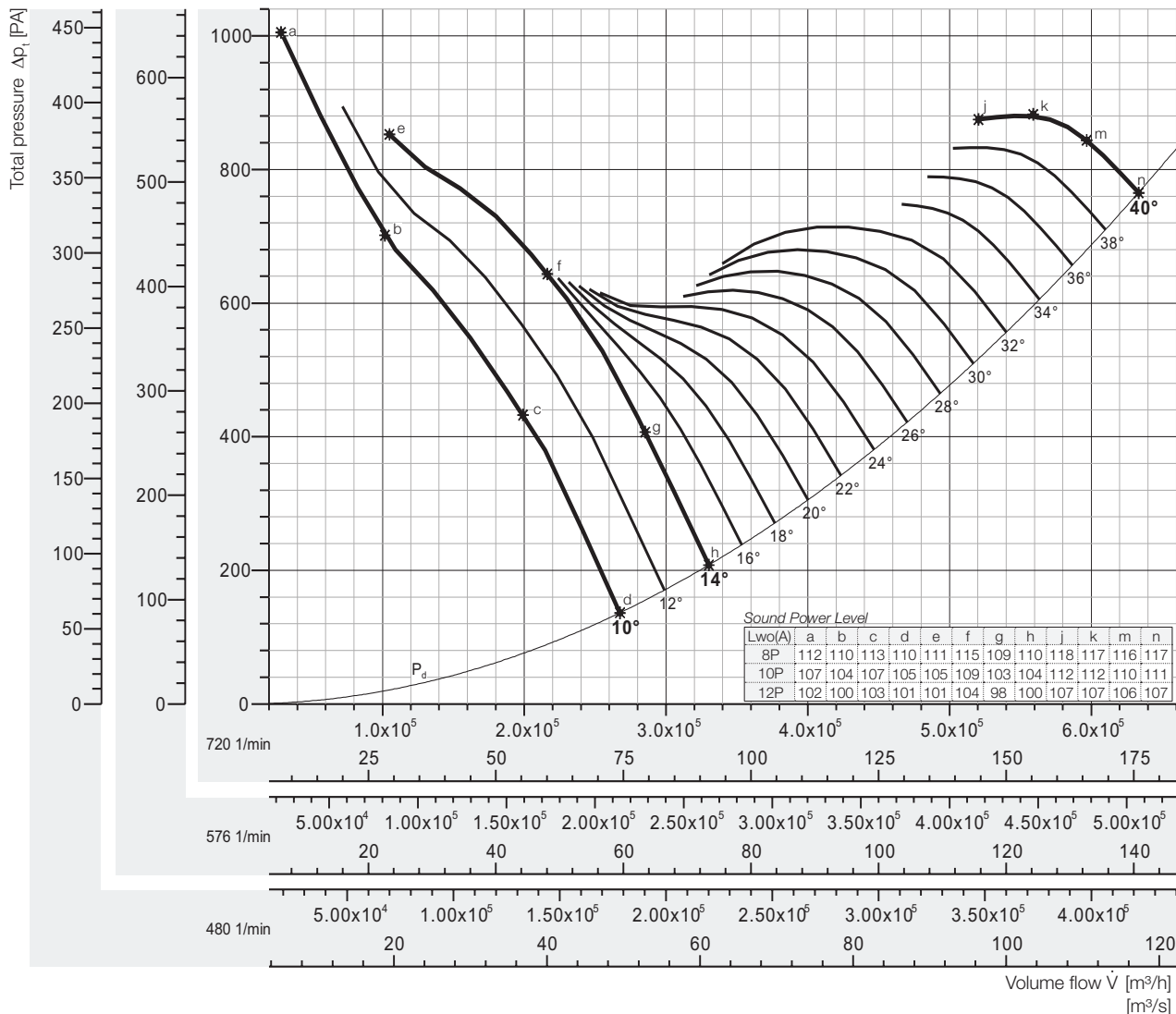
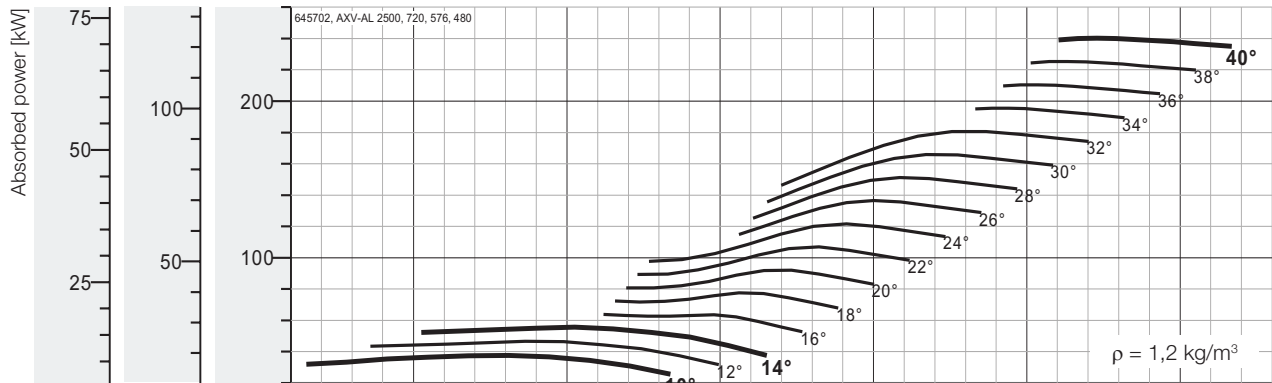

Speed [min<sup>-1</sup>]  
720  
8-pol  
576  
10-pol  
480  
12-pol

## Peak absorbed power [kW]

n [min <sup>-1</sup> ]	Pitch angle [°]																
	8	10	12	14	16	18	20	22	24	26	28	30	32	34	36	38	40
480 motor	-	11,2	13,8	16,5	18,9	23,0	27,3	31,7	36,1	40,4	44,8	49,2	53,5	57,9	62,4	66,8	71,2
576 motor	-	15	23,9	28,5	32,7	39,7	47,1	54,7	62,3	69,9	77,4	84,9	92,4	100,1	107,7	115,3	122,9
720 motor	-	37,8	46,6	55,6	63,8	77,6	92,1	106,9	121,7	136,5	151,2	165,9	180,6	195,6	210,4	225,3	240,1

Fan test laboratory AMCA 210 Test Chamber. Performance certified is for installation type A - Free inlet, free outlet. Performance ratings do not include the effects of appurtenances (accessories-belt cover, pulley & belt).

Dimensions + Accessories Page 191 - 194;  
Sound power frequency spectrum L<sub>wa</sub> Page 196 - 200.

The A-weighted sound ratings shown have been calculated per AMCA International Standard 301. Values shown are for outlet L<sub>wa</sub> sound power levels for installation type A: free inlet, free outlet.





# Performance Curve

AXV 2600-780-6, 50 Hz

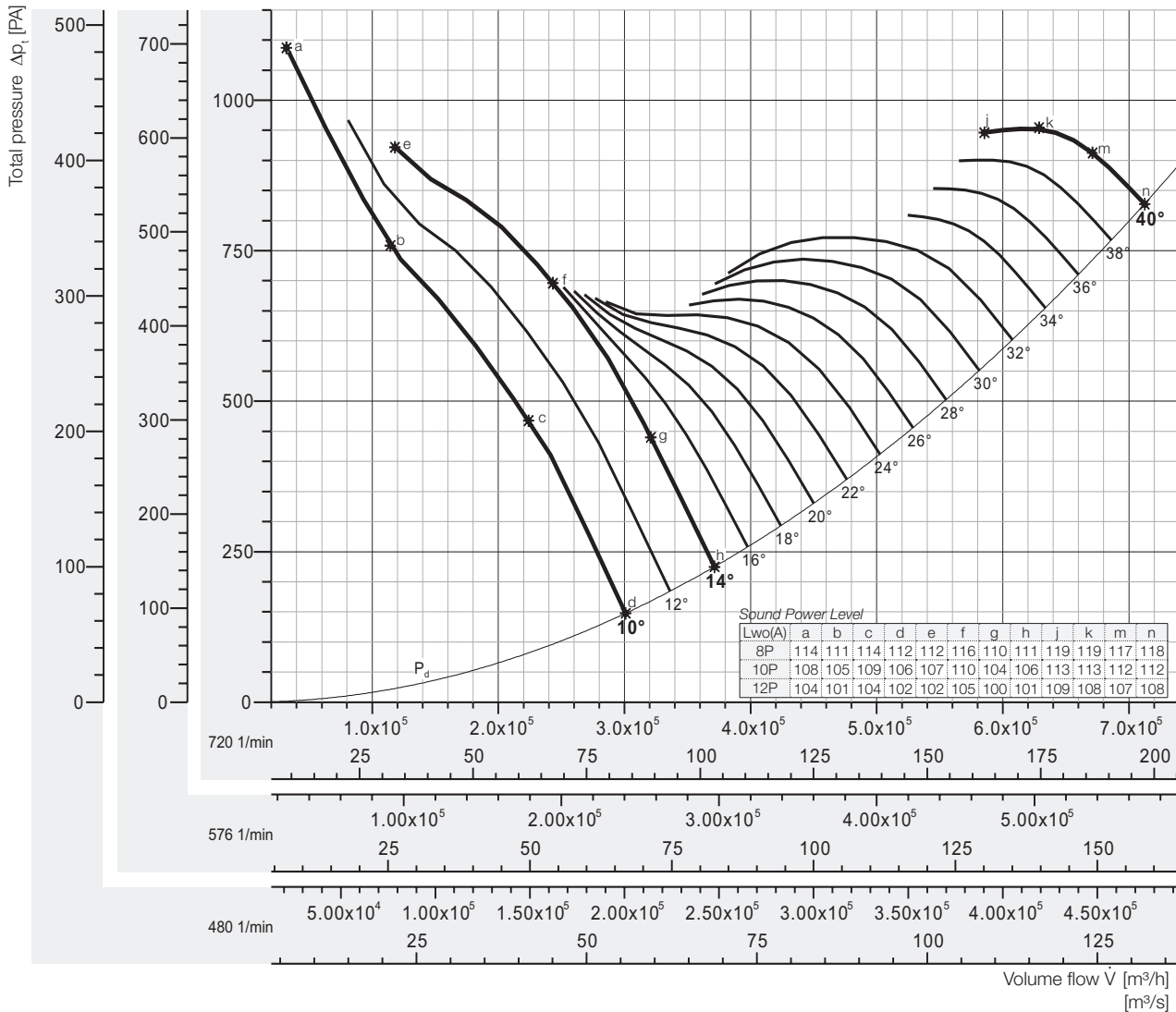
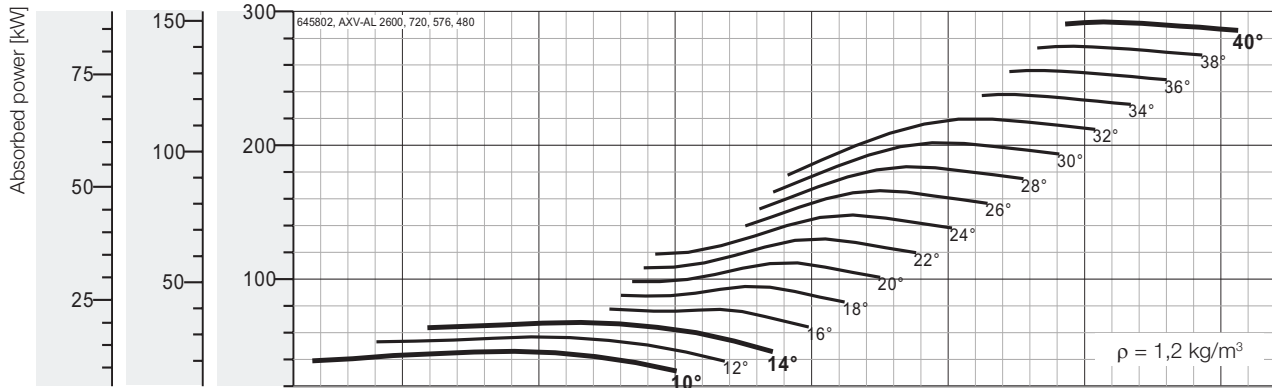

## Peak absorbed power [kW]

n [min <sup>-1</sup> ]	Pitch angle [°]																
	8	10	12	14	16	18	20	22	24	26	28	30	32	34	36	38	40
480 motor	-	13,6	16,8	20,0	23,0	28,0	33,2	38,5	43,9	49,2	54,5	59,8	65,1	70,5	75,8	81,2	86,5
		15	18,5	22	30		37	45		55		75		90			
576 motor	-	23,5	29,0	34,6	39,8	48,3	57,3	66,6	75,8	85,0	94,2	103,3	112,4	121,8	131,1	140,3	149,5
		30		37	45	55	75	90		110		132			160		
720 motor	-	46,0	56,7	67,6	77,6	94,4	112,0	130,1	148,1	166,0	184,0	201,8	219,6	237,9	255,9	274,0	292,1
		55	75		90	110	132		160	200		250			315		

Fan test laboratory AMCA 210 Test Chamber. Performance certified is for installation type A - Free inlet, Free outlet. Performance ratings do not include the effects of appurtenances (accessories-belt cover, pulley & belt).

The A-weighted sound ratings shown have been calculated per AMCA International Standard 301. Values shown are for outlet LwoA sound power levels for installation Type A: free inlet, free outlet.

Dimensions + Accessories Page 191 - 194;  
Sound power frequency spectrum L<sub>max</sub> Page 196 - 200.



# Performance Curve

AXV 2800-840-6, 50 Hz

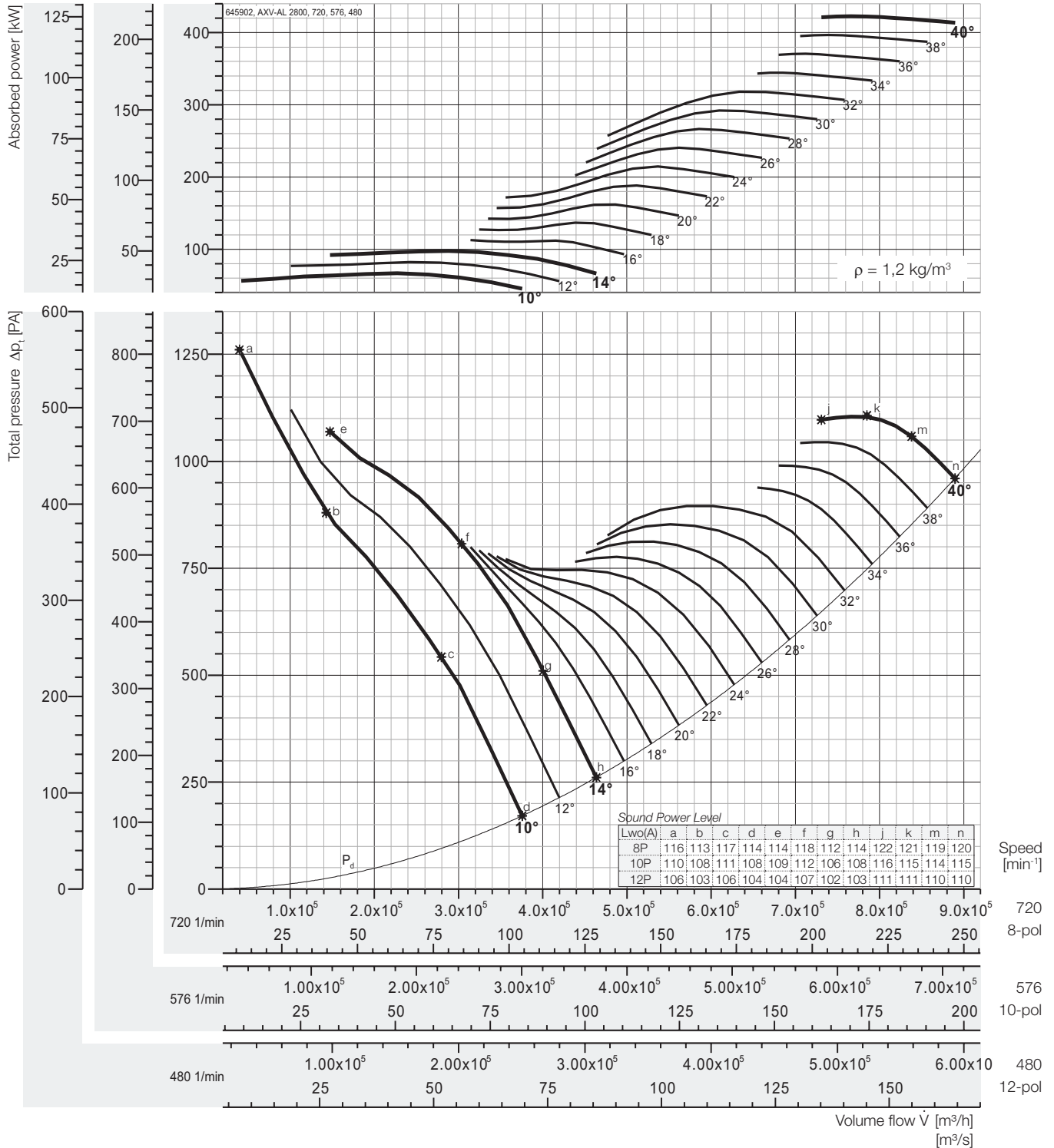

## Peak absorbed power [kW]

n [min <sup>-1</sup> ]	Pitch angle [°]																
	8	10	12	14	16	18	20	22	24	26	28	30	32	34	36	38	40
480 motor	-	19,7	24,3	29,0	33,3	40,5	48,0	55,8	63,5	71,2	78,9	86,6	94,2	102,1	109,8	117,6	125,3
576 motor	-	34,1	42,0	50,1	57,6	70,0	83,0	96,4	109,8	123,1	136,4	149,6	162,8	176,4	189,8	203,1	216,5
720 motor	-	66,6	82,1	97,9	112,4	136,6	162,1	188,3	214,4	240,4	266,4	292,2	318,0	344,5	370,6	396,8	422,9

Fan test laboratory AMCA 210 Test Chamber. Performance certified is for installation type A - Free inlet, free outlet. Performance ratings do not include the effects of appurtenances (accessories-belt cover, pulley & belt).

Dimensions + Accessories Page 191 - 194;  
Sound power frequency spectrum L<sub>w</sub> Page 196 - 200.

The A-weighted sound ratings shown have been calculated per AMCA International Standard 301. Values shown are for outlet L<sub>w</sub>A sound power levels for installation type A: free inlet, free outlet.



### Introducing the Fan Energy Index

The FEI is a ratio of the actual fan efficiency to a baseline fan efficiency, both calculated at a given airflow and pressure point (FEI<sub>s</sub> is calculated using a static pressure basis, FEI<sub>t</sub> is calculated using a total pressure basis). Since these efficiencies are each calculated at the same airflow and pressure, FEI is also defined as the ratio of the baseline electrical power to the actual electrical power of a fan.

The FEI was designed to encourage responsible application of fans and drive significant and quantifiable energy savings through energy codes, utility rebate programs and federal regulations. This is accomplished by establishing the minimum fan efficiency or maximum fan electrical input power at design airflow and pressure. The FEI can be used by:

- Regulators to improve the efficiency of fan designs and limit market availability of less efficient fans
- Utilities to establish rebate programs to incentivize the efficient use of fans
- Code bodies to drive building owners and contractors to using more energy efficient fans for ventilation and process applications
- Purchasing agents to evaluate the fan selections and their suitability for specific applications

### Selection Example

The **direct driven** axial fan AXV 450-110-6/20° with three-phase **50Hz** motor power supply, by plotting the FEI curve as per the right graph, the FEI<sub>t</sub> value will be 2.18 under the duty **4,000CMH** airflow, **122Pa total pressure** running at **1,500rpm**.

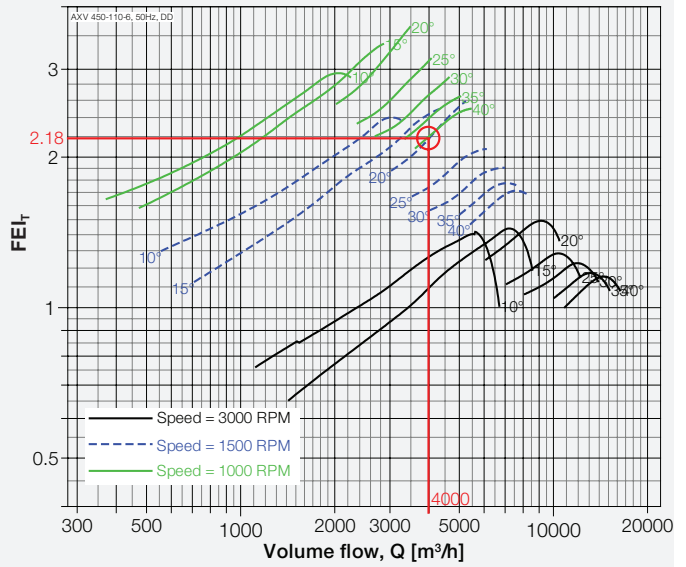

### Direct Driven Models, Size from 250 to 2800, 50Hz

Model: AXV 250-110-3

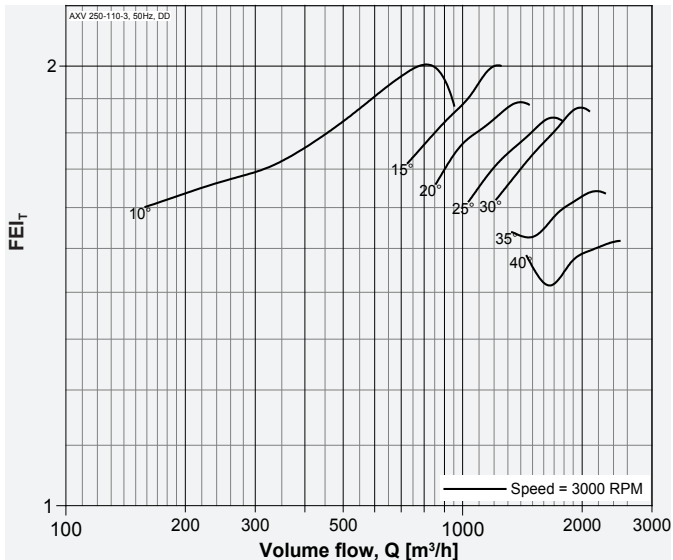

Model: AXV 250-110-6

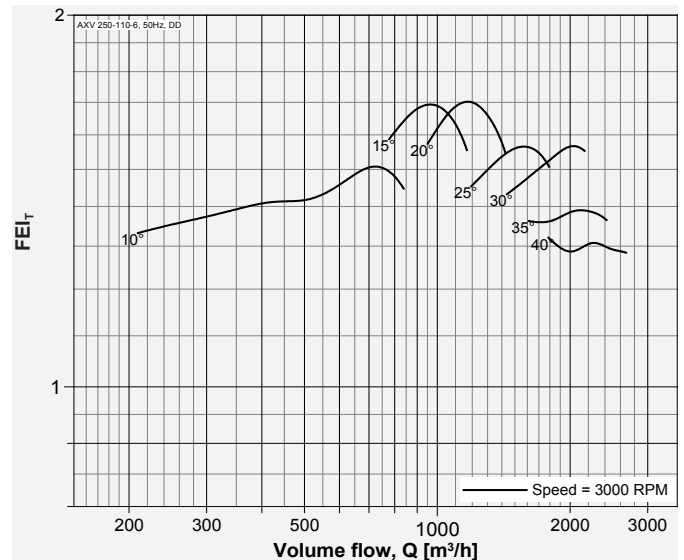

Model: AXV 280-110-3

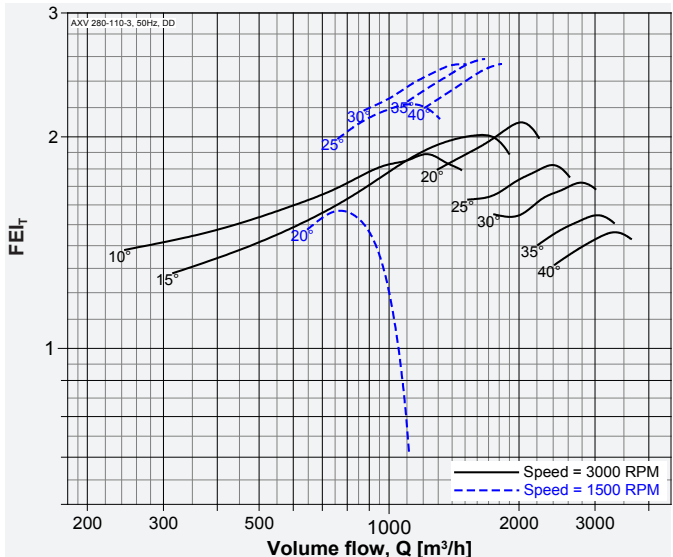

Model: AXV 280-110-6

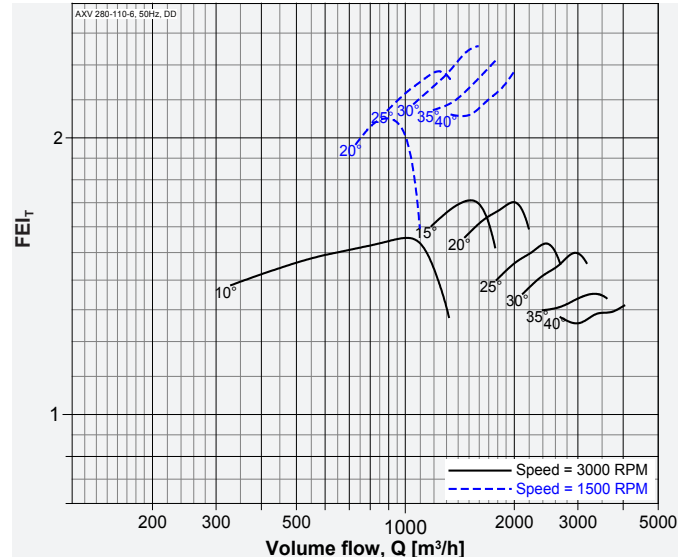

Performance of size 250 to 1250 certified is for installation type D - Ducted inlet, Ducted outlet, Performance of size 1400 to 2800 certified is for installation type A - Free inlet, Free outlet. Power rating (kW) does not include transmission losses. Performance ratings do not include the effects of appurtenances (accessories-belt cover, pulley & belt). FEI<sub>t</sub> / FEI<sub>s</sub> values are calculated in accordance with ANSI/AMCA Standard 208 and are based on default motor efficiencies (Direct Driven type). FEI<sub>t</sub> / FEI<sub>s</sub> values for fans with specific motors will vary slightly from those shown.



Model: AXV 315-110-3

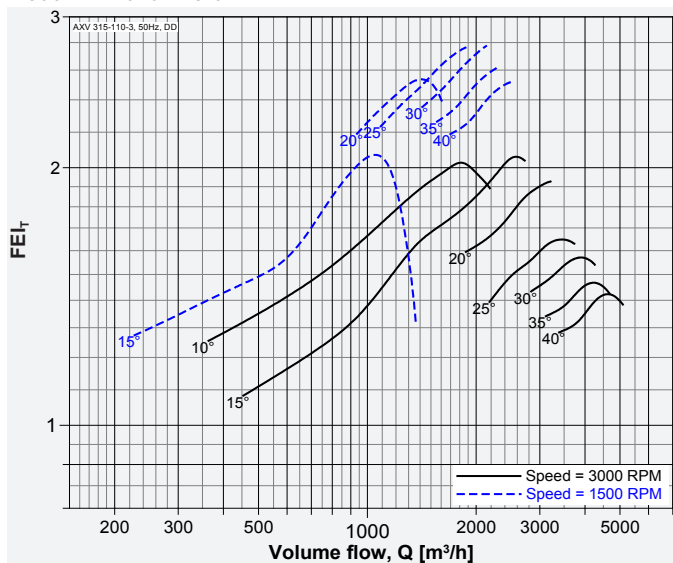

Model: AXV 315-110-6

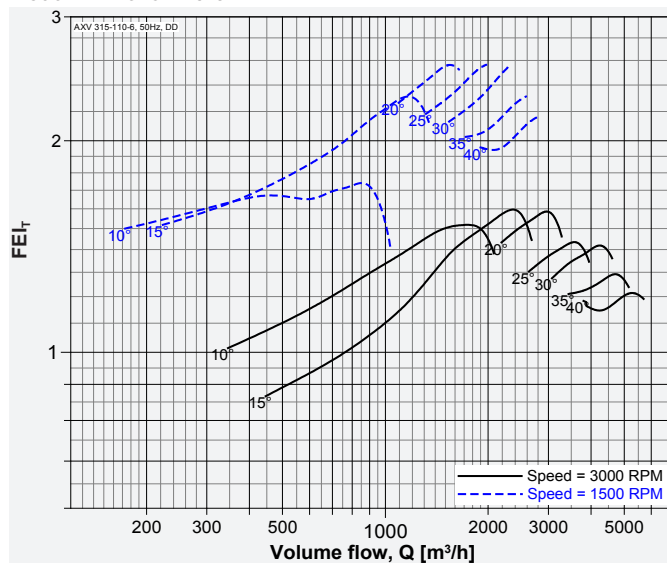

Model: AXV 355-110-3

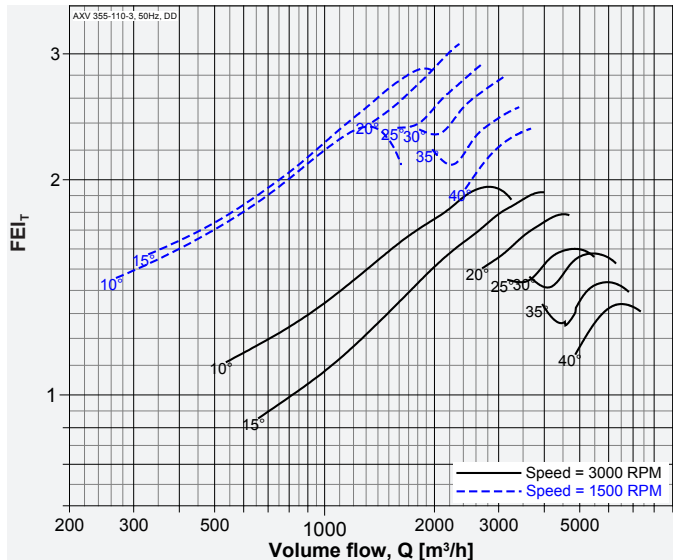

Model: AXV 355-110-6

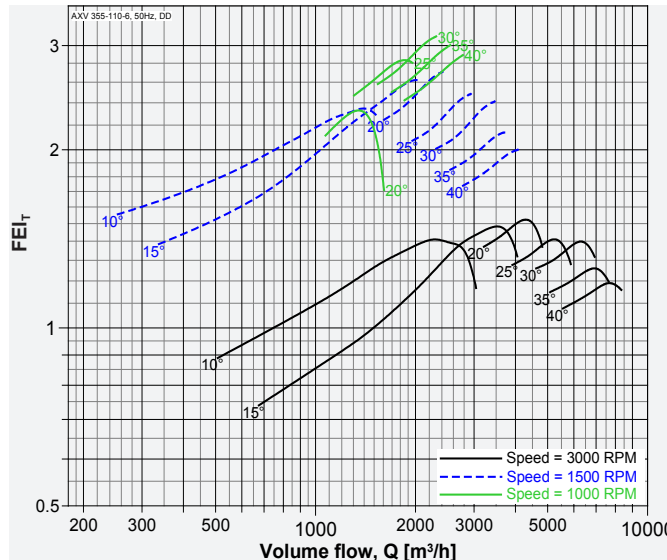

Model: AXV 355-150-7

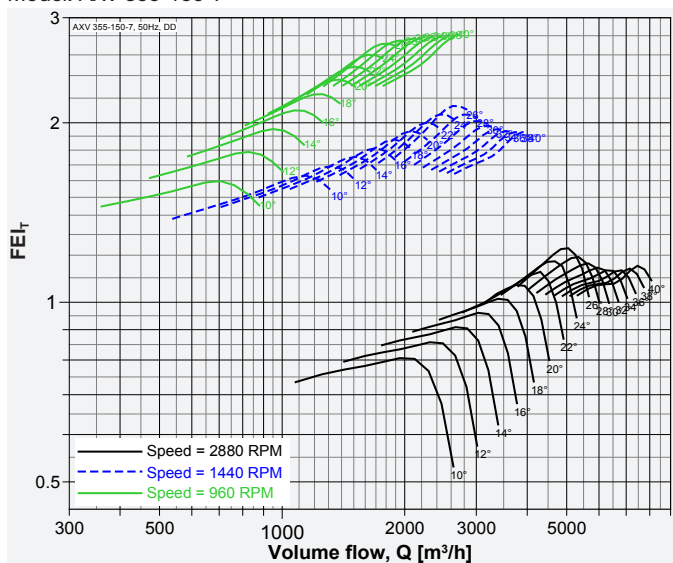

Model: AXV 400-110-3

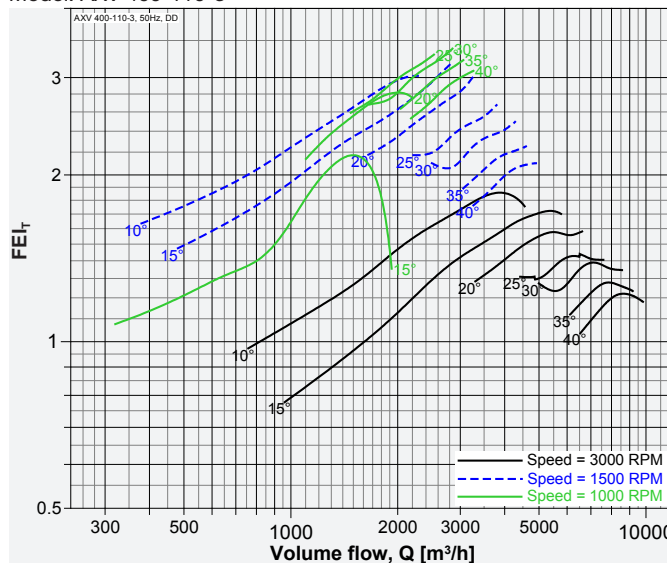

Performance of size 250 to 1250 certified is for installation type D - Ducted inlet, Ducted outlet, Performance of size 1400 to 2800 certified is for installation type A - Free inlet, Free outlet. Power rating (kW) does not include transmission losses. Performance ratings do not include the effects of appurtenances (accessories-belt cover, pulley & belt). FEI<sub>t</sub> / FEI<sub>s</sub> values are calculated in accordance with ANSI/AMCA Standard 208 and are based on default motor efficiencies (Direct Driven type). FEI<sub>t</sub> / FEI<sub>s</sub> values for fans with specific motors will vary slightly from those shown.



Model: AXV 400-110-6

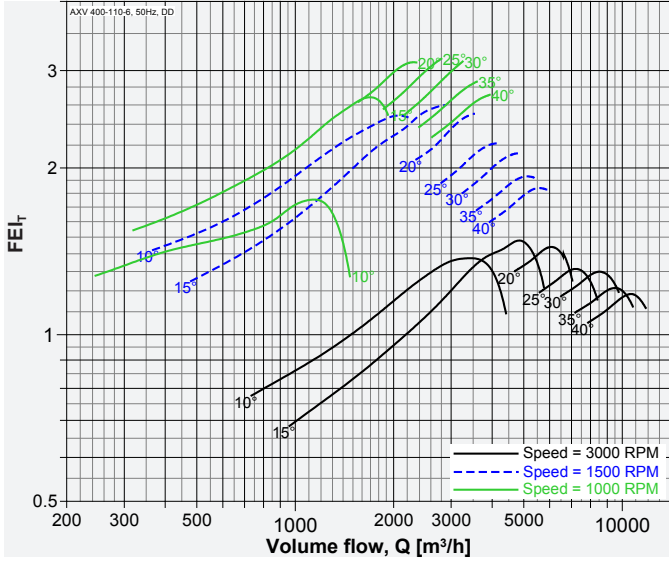

Model: AXV 400-150-5

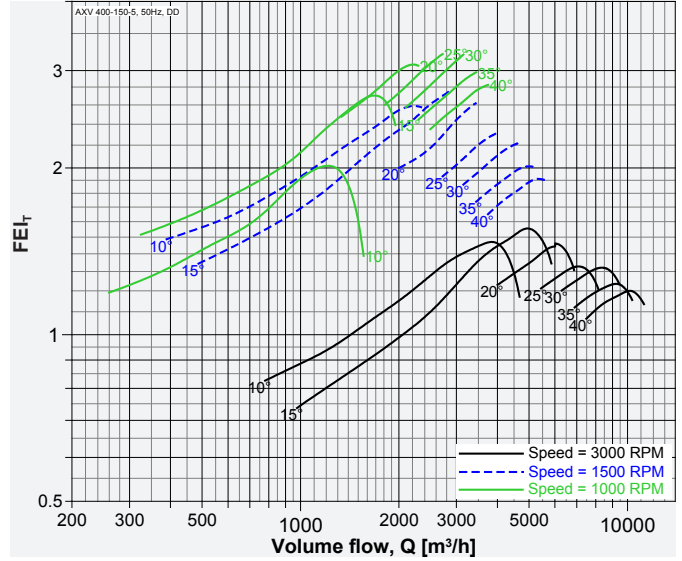

Model: AXV 400-150-7

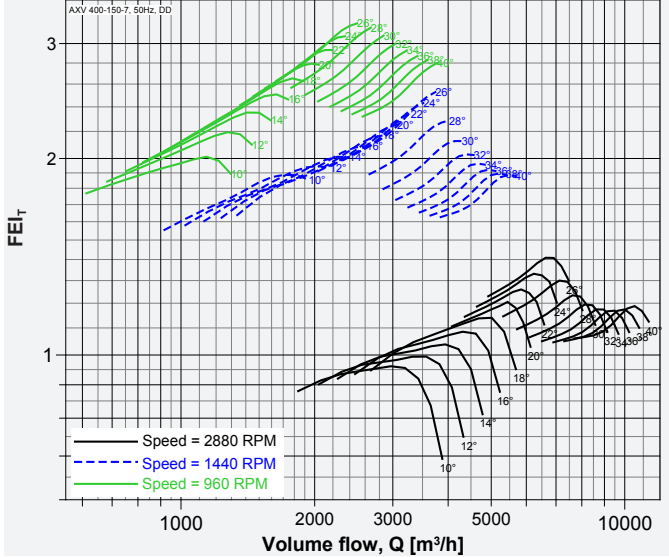

Model: AXV 400-150-10

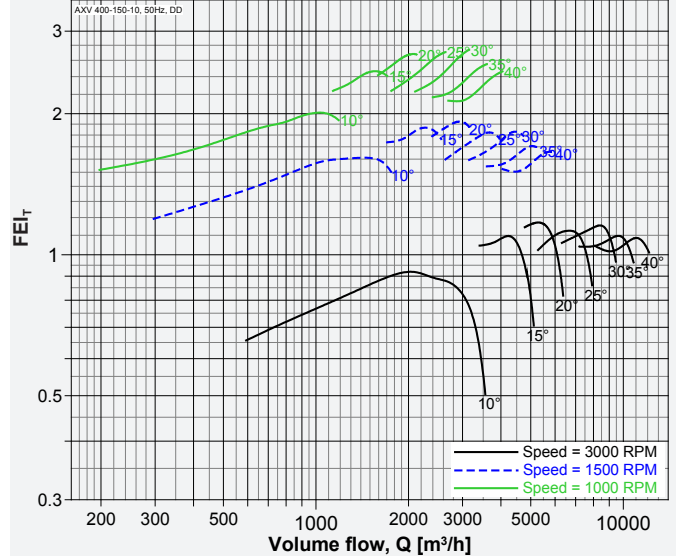

Model: AXV 450-110-3

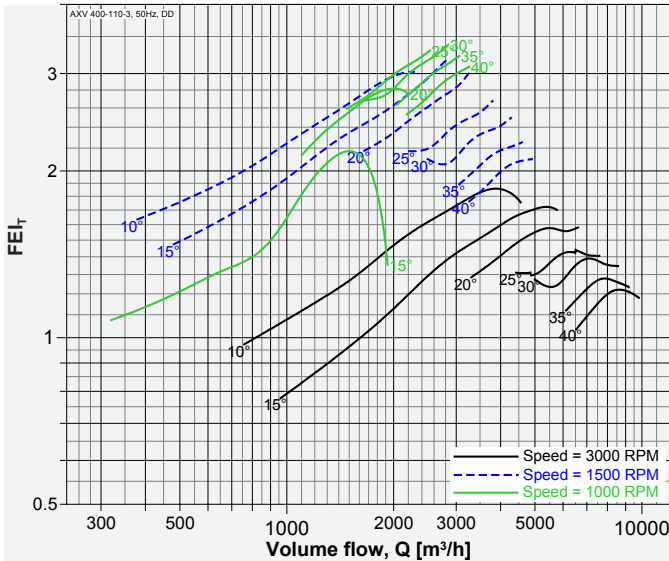

Model: AXV 450-110-6

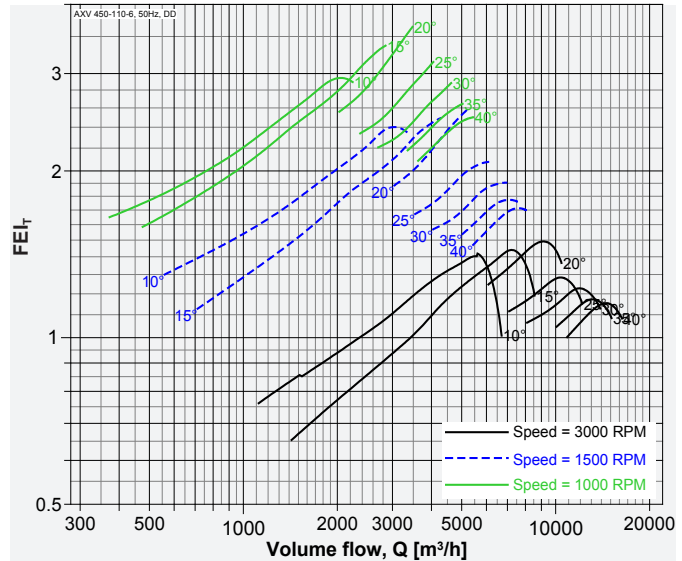

Performance of size 250 to 1250 certified is for installation type D - Ducted inlet, Ducted outlet, Performance of size 1400 to 2800 certified is for installation type A - Free inlet, Free outlet. Power rating (kW) does not include transmission losses. Performance ratings do not include the effects of appurtenances (accessories-belt cover, pulley & belt). FEI<sub>T</sub> / FEI<sub>S</sub> values are calculated in accordance with ANSI/AMCA Standard 208 and are based on default motor efficiencies (Direct Driven type). FEI<sub>T</sub> / FEI<sub>S</sub> values for fans with specific motors will vary slightly from those shown.



Model: AXV 450-150-5

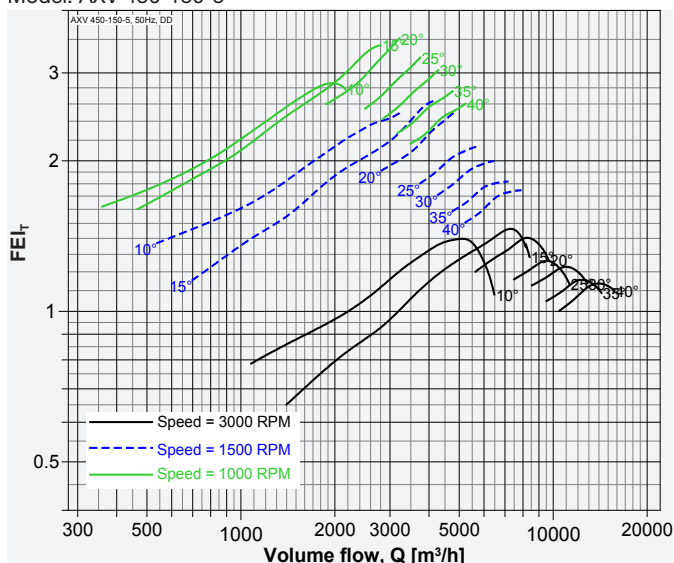

Model: AXV 450-150-7

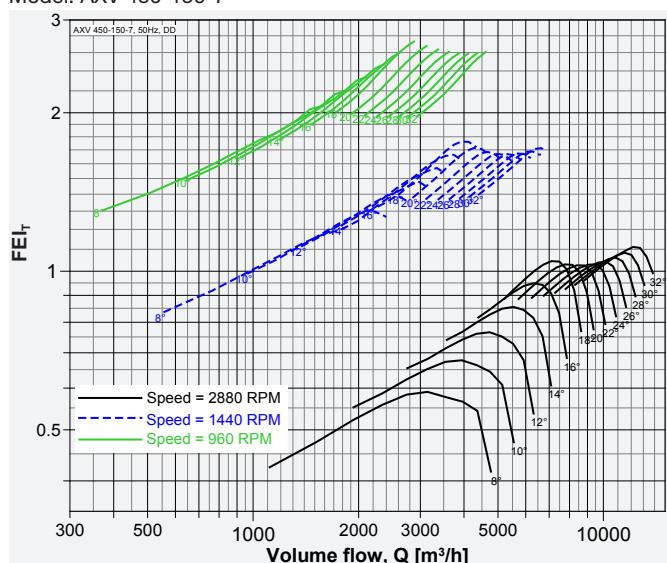

Model: AXV 450-150-10

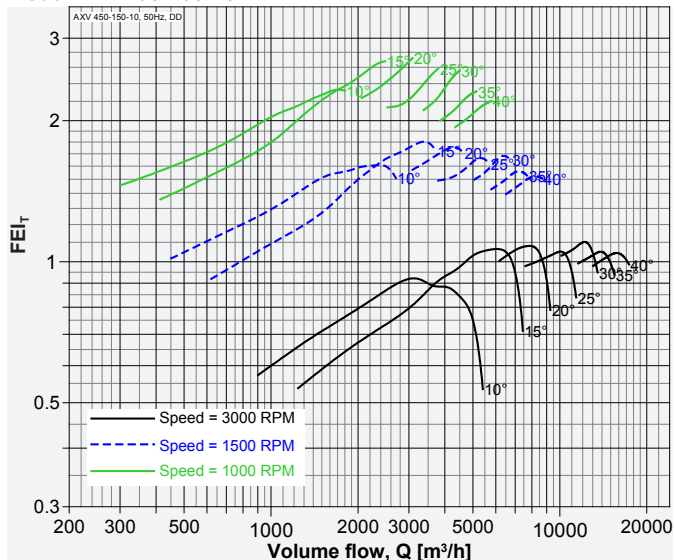

Model: AXV 500-110-3

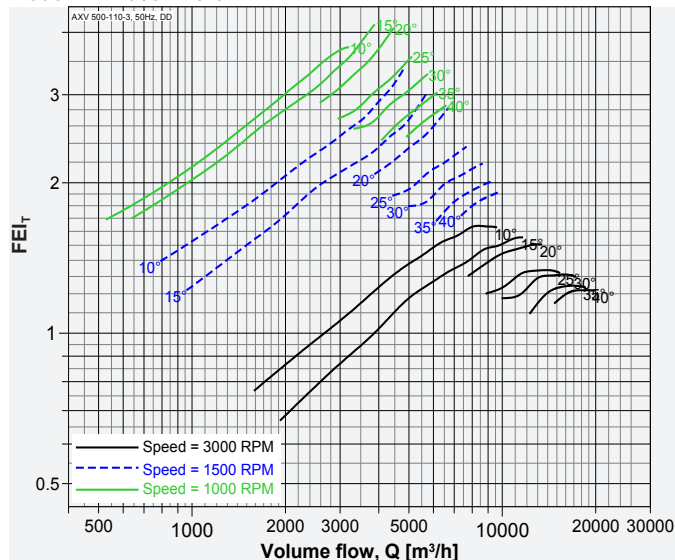

Model: AXV 500-110-6

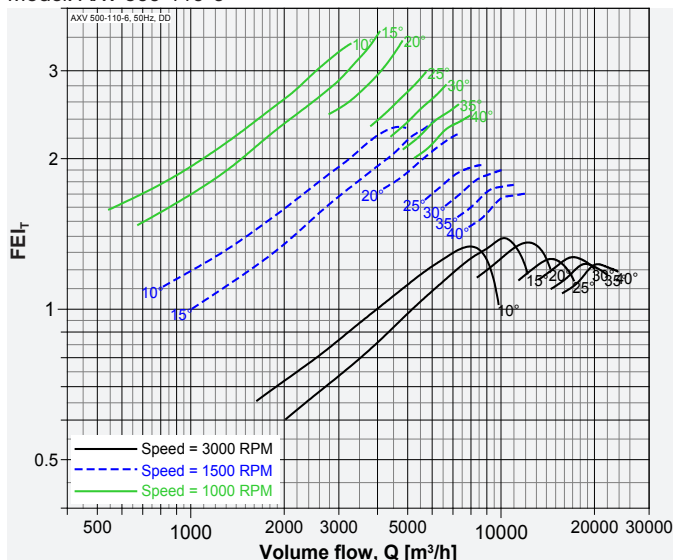

Model: AXV 500-150-5

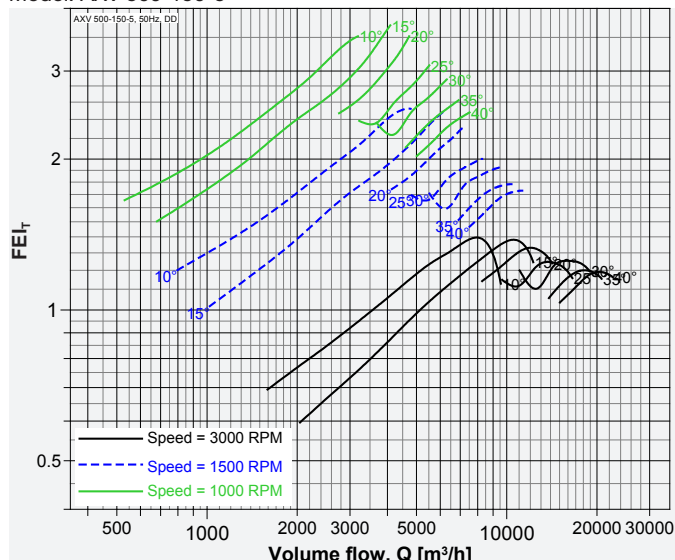

Performance of size 250 to 1250 certified is for installation type D - Ducted inlet, Ducted outlet, Performance of size 1400 to 2800 certified is for installation type A - Free inlet, Free outlet. Power rating (kW) does not include transmission losses. Performance ratings do not include the effects of appurtenances (accessories-belt cover, pulley & belt). FEI<sub>t</sub> / FEI<sub>s</sub> values are calculated in accordance with ANSI/AMCA Standard 208 and are based on default motor efficiencies (Direct Driven type). FEI<sub>t</sub> / FEI<sub>s</sub> values for fans with specific motors will vary slightly from those shown.



Model: AXV 500-150-7

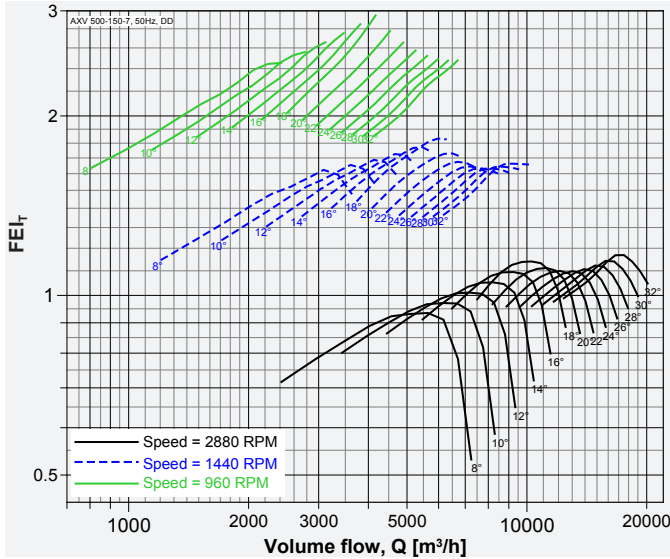

Model: AXV 500-150-10

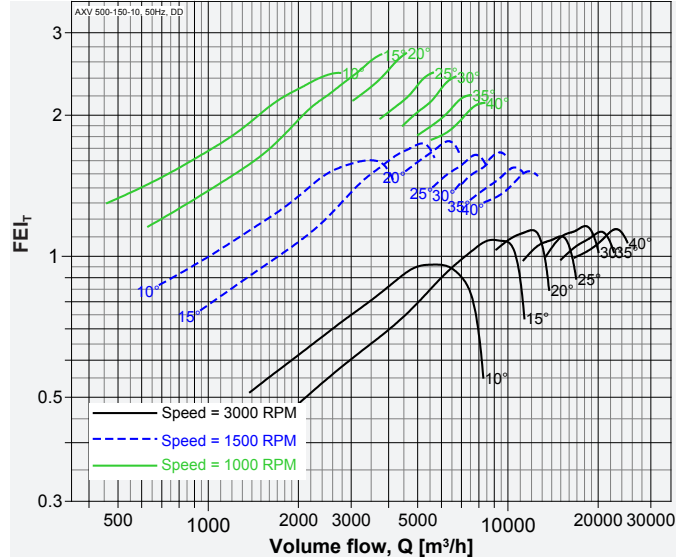

Model: AXV 500-250-7

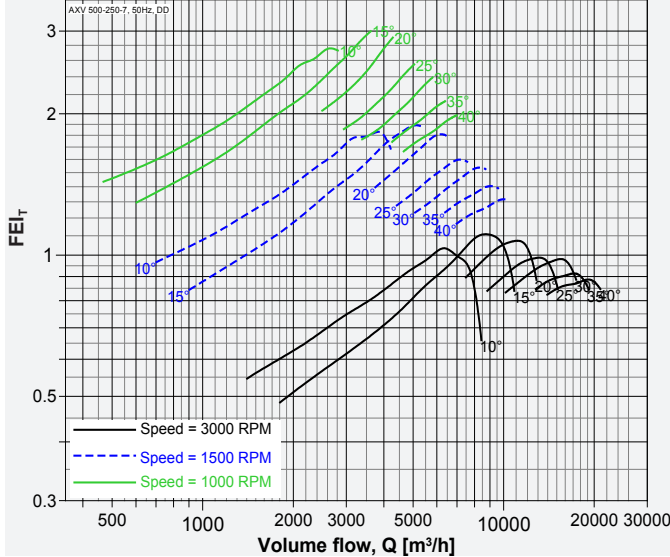

Model: AXV 560-110-3

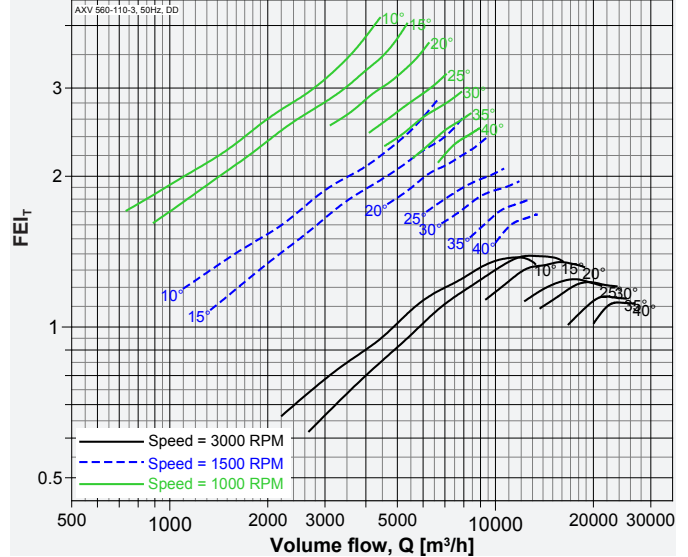

Model: AXV 560-110-6

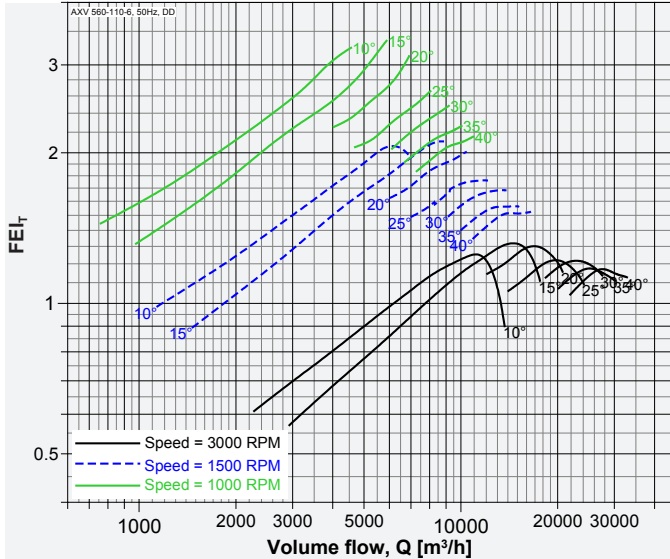

Model: AXV 560-150-5

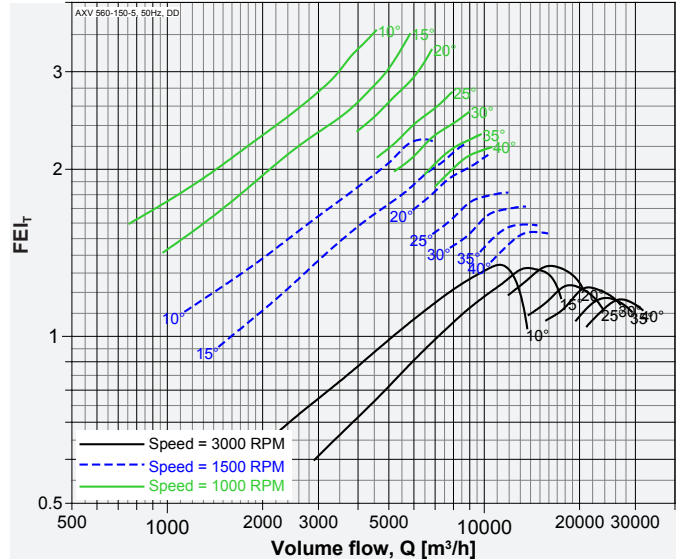

Performance of size 250 to 1250 certified is for installation type D - Ducted inlet, Ducted outlet, Performance of size 1400 to 2800 certified is for installation type A - Free inlet, Free outlet. Power rating (kW) does not include transmission losses. Performance ratings do not include the effects of appurtenances (accessories-belt cover, pulley & belt). FEI<sub>T</sub> / FEI<sub>S</sub> values are calculated in accordance with ANSI/AMCA Standard 208 and are based on default motor efficiencies (Direct Driven type). FEI<sub>T</sub> / FEI<sub>S</sub> values for fans with specific motors will vary slightly from those shown.



Model: AXV 560-150-10

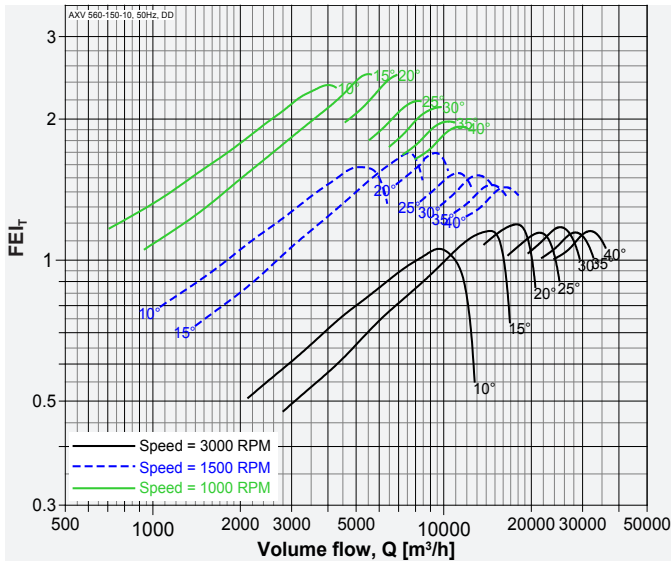

Model: AXV 560-200-9

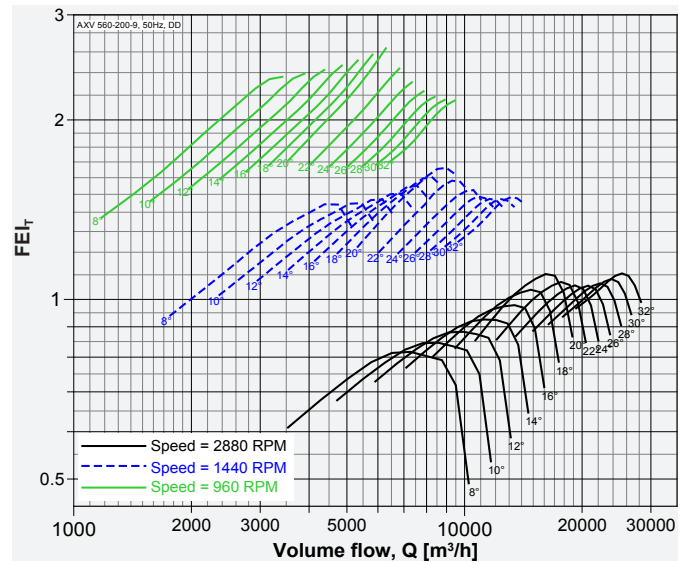

Model: AXV 560-250-7

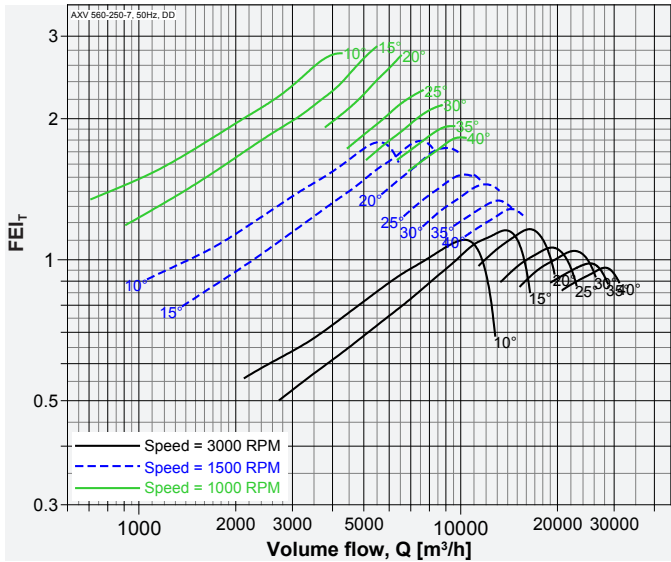

Model: AXV 560-250-14

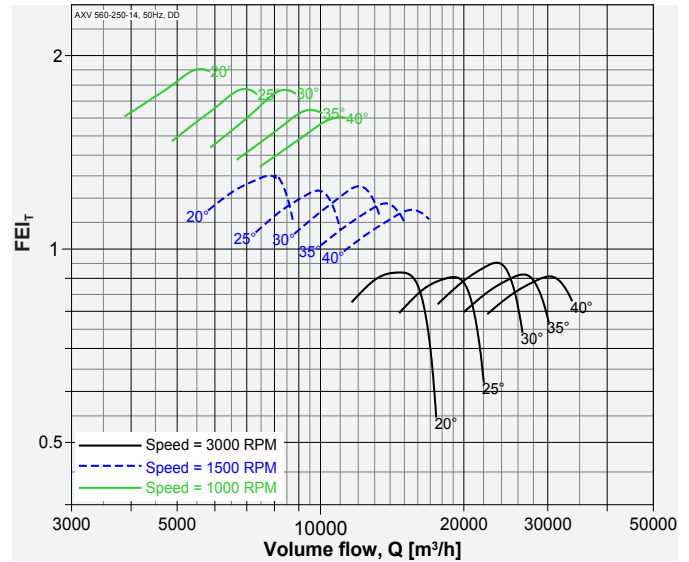

Model: AXV 630-110-3

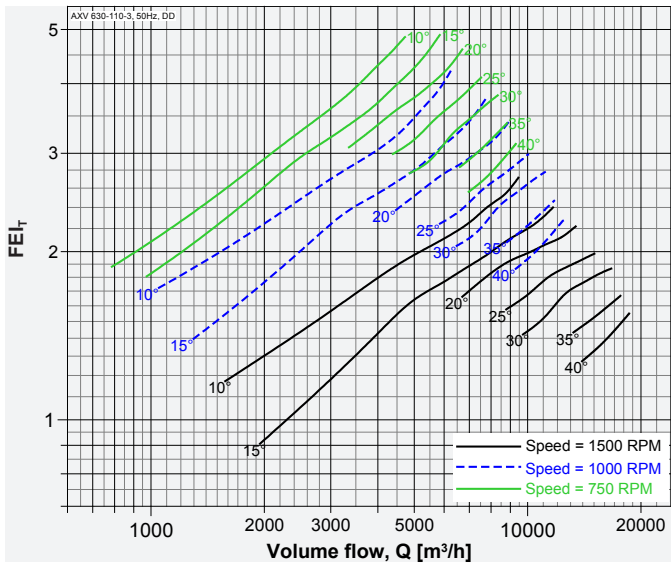

Model: AXV 630-110-6

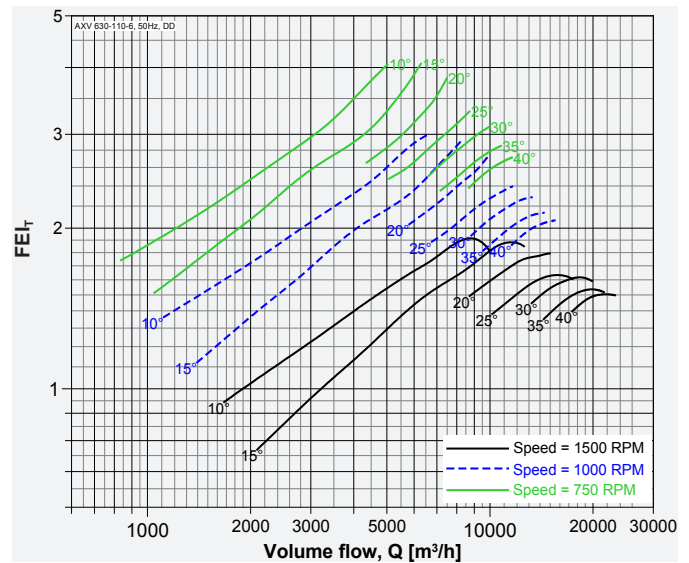

Performance of size 250 to 1250 certified is for installation type D - Ducted inlet, Ducted outlet, Performance of size 1400 to 2800 certified is for installation type A - Free inlet, Free outlet. Power rating (kW) does not include transmission losses. Performance ratings do not include the effects of appurtenances (accessories-belt cover, pulley & belt). FEI<sub>T</sub> / FEI<sub>S</sub> values are calculated in accordance with ANSI/AMCA Standard 208 and are based on default motor efficiencies (Direct Driven type). FEI<sub>T</sub> / FEI<sub>S</sub> values for fans with specific motors will vary slightly from those shown.





Model: AXV 630-150-5

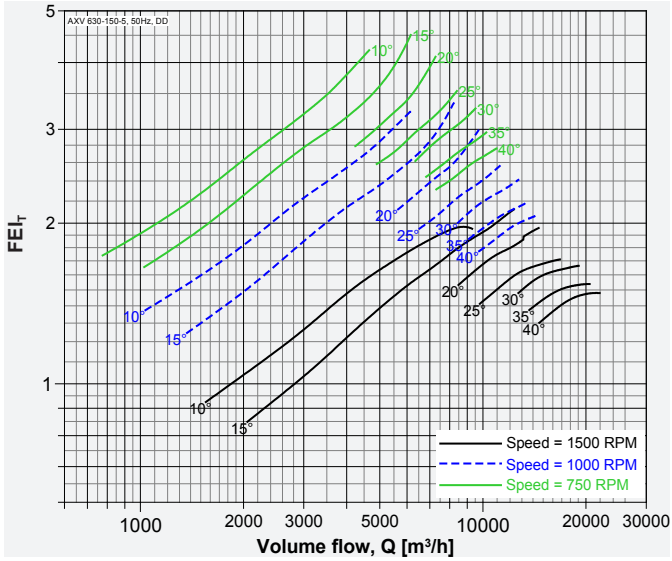

Model: AXV 630-150-10

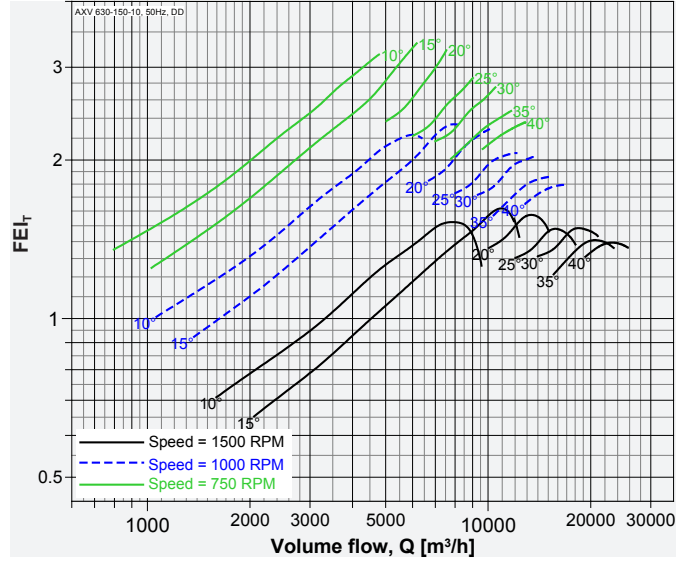

Model: AXV 630-200-9

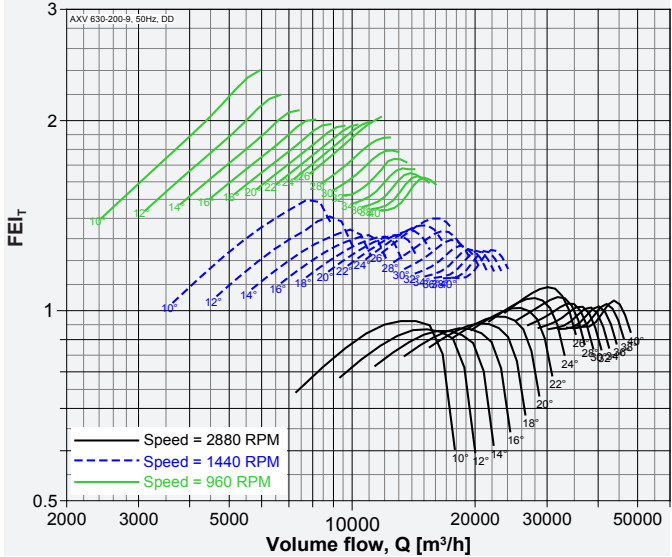

Model: AXV 630-250-7

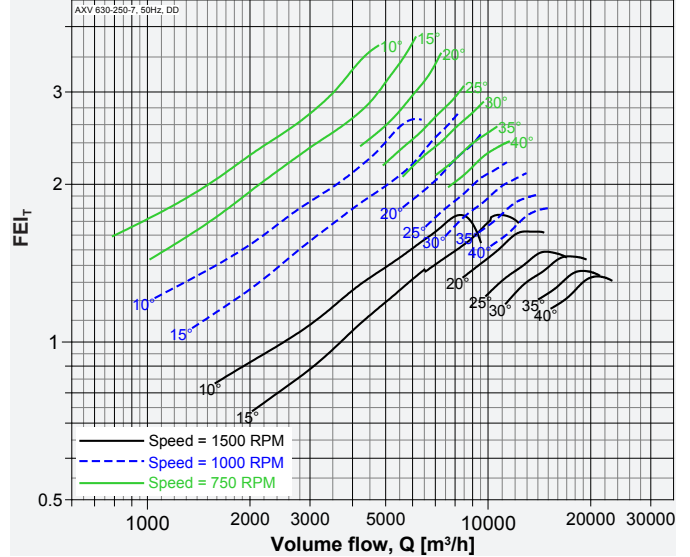

Model: AXV 630-250-14

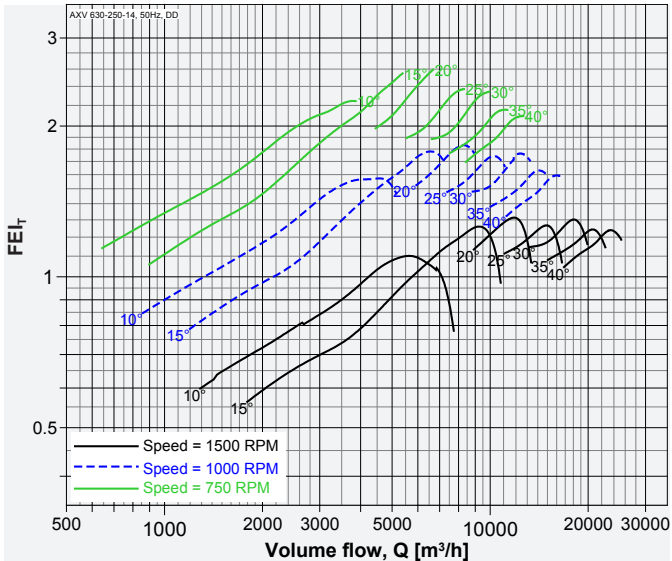

Model: AXV 710-110-3

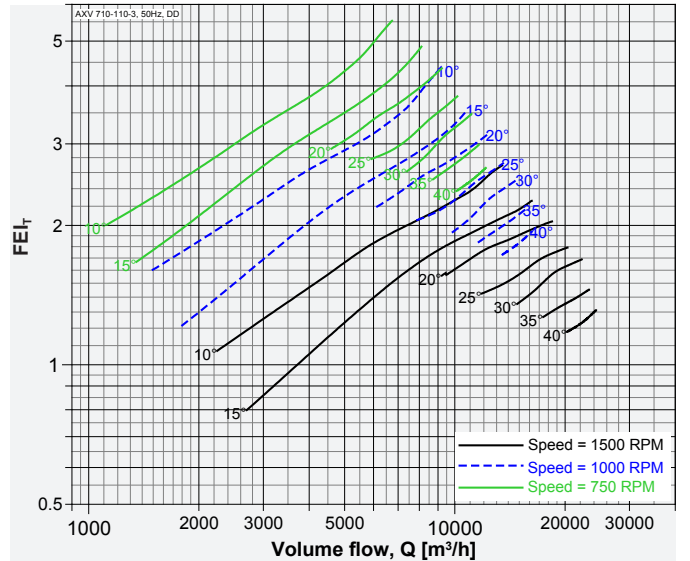

Performance of size 250 to 1250 certified is for installation type D - Ducted inlet, Ducted outlet, Performance of size 1400 to 2800 certified is for installation type A - Free inlet, Free outlet. Power rating (kW) does not include transmission losses. Performance ratings do not include the effects of appurtenances (accessories-belt cover, pulley & belt). FEI<sub>1</sub> / FEI<sub>2</sub> values are calculated in accordance with ANSI/AMCA Standard 208 and are based on default motor efficiencies (Direct Driven type). FEI<sub>1</sub> / FEI<sub>2</sub> values for fans with specific motors will vary slightly from those shown.



Model: AXV 710-110-6

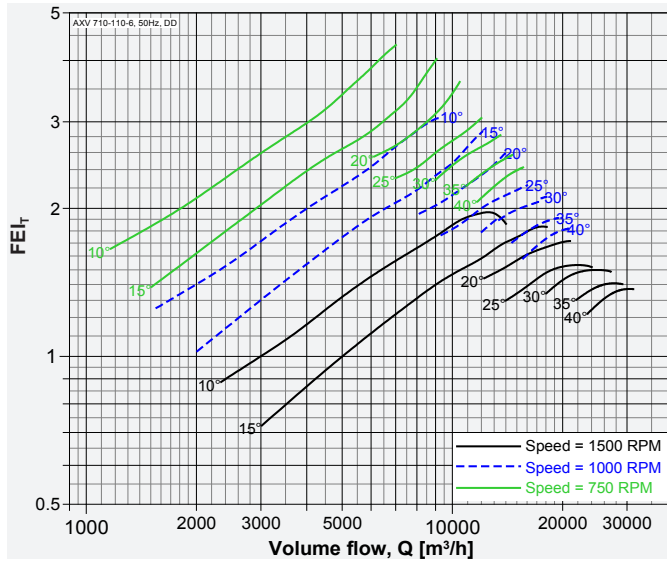

Model: AXV 710-150-5

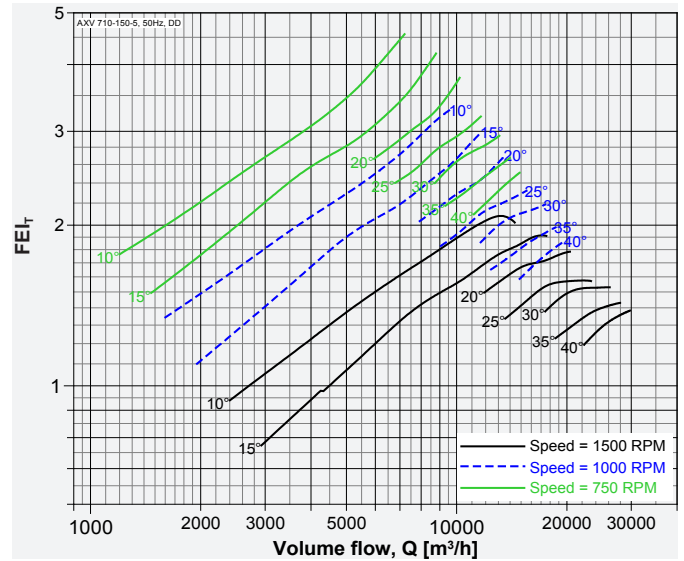

Model: AXV 710-150-10

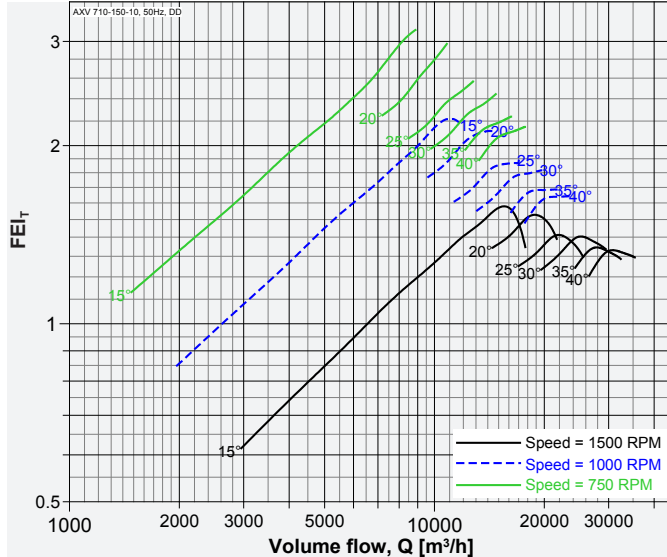

Model: AXV 710-250-7

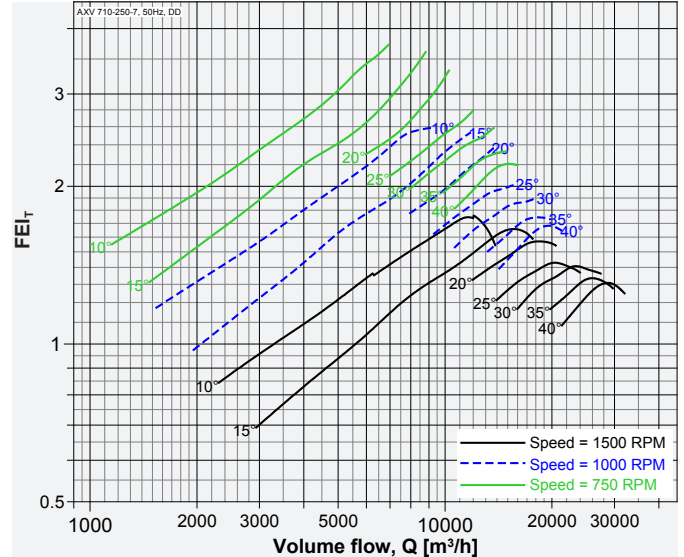

Model: AXV 710-250-9

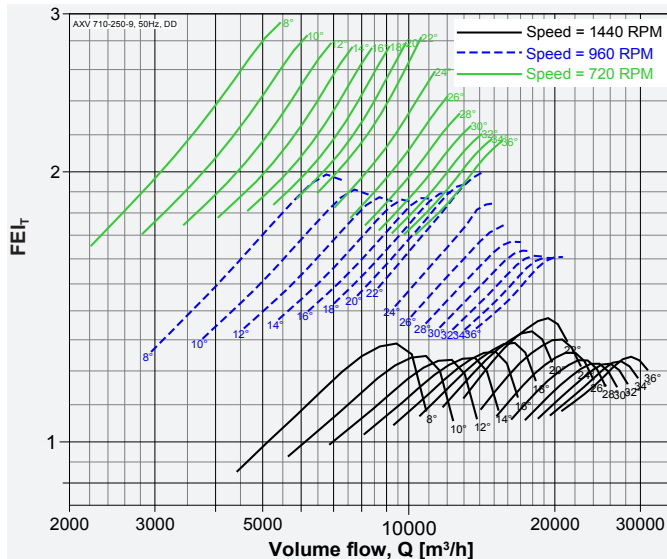

Model: AXV 710-250-14

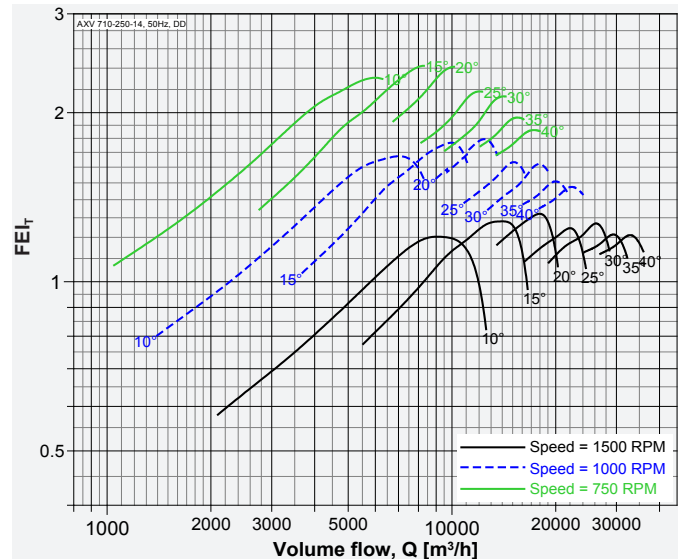

Performance of size 250 to 1250 certified is for installation type D - Ducted inlet, Ducted outlet, Performance of size 1400 to 2800 certified is for installation type A - Free inlet, Free outlet. Power rating (kW) does not include transmission losses. Performance ratings do not include the effects of appurtenances (accessories-belt cover, pulley & belt).  $FEI_1$  /  $FEI_3$  values are calculated in accordance with ANSI/AMCA Standard 208 and are based on default motor efficiencies (Direct Driven type).  $FEI_1$  /  $FEI_3$  values for fans with specific motors will vary slightly from those shown.



Model: AXV 800-150-5

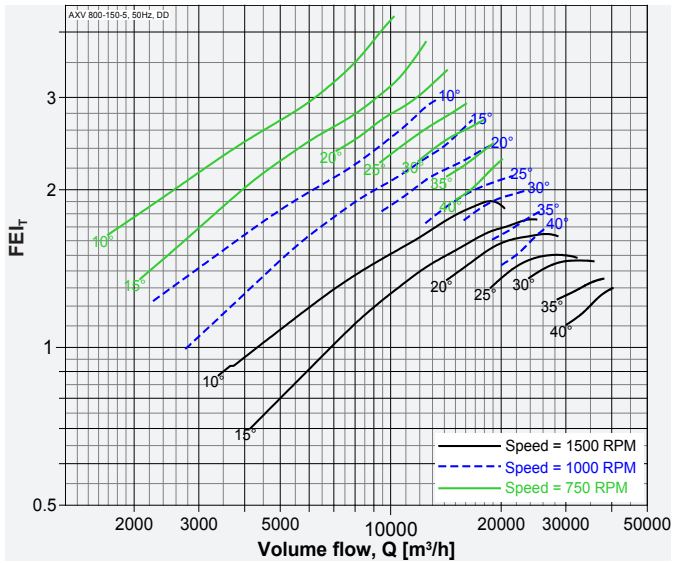

Model: AXV 800-150-10

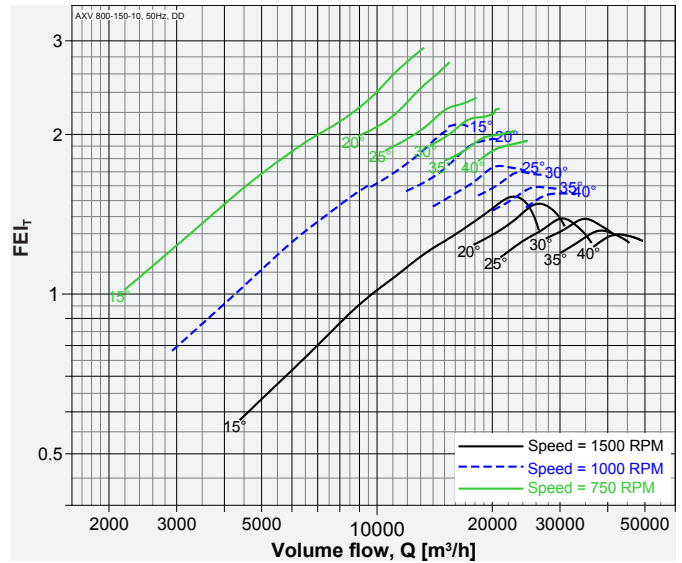

Model: AXV 800-250-7

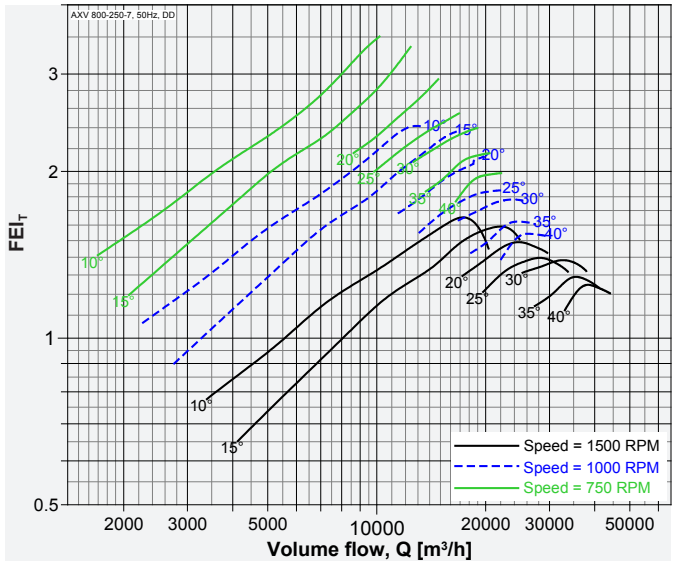

Model: AXV 800-250-9

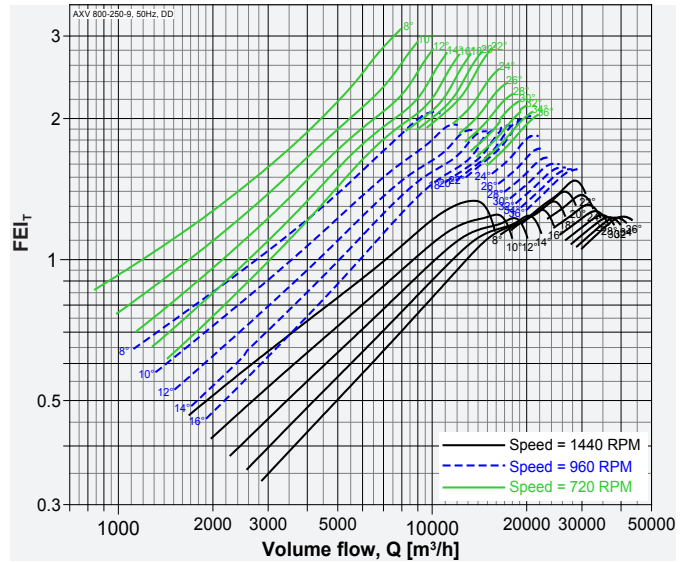

Model: AXV 800-250-14

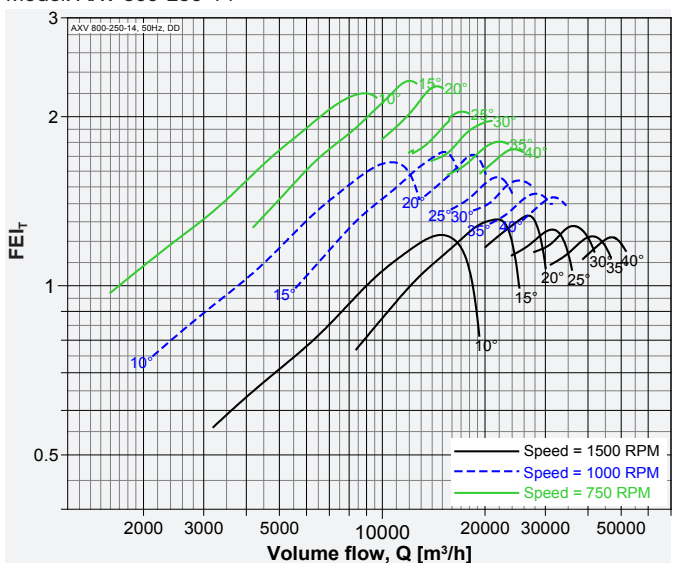

Model: AXV 900-250-7

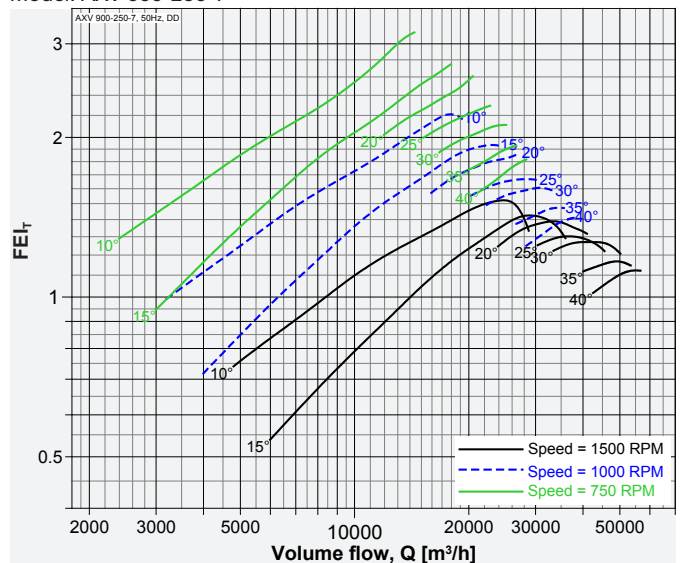

Performance of size 250 to 1250 certified is for installation type D - Ducted inlet, Ducted outlet, Performance of size 1400 to 2800 certified is for installation type A - Free inlet, Free outlet. Power rating (kW) does not include transmission losses. Performance ratings do not include the effects of appurtenances (accessories-belt cover, pulley & belt). FEI<sub>t</sub> / FEI<sub>s</sub> values are calculated in accordance with ANSI/AMCA Standard 208 and are based on default motor efficiencies (Direct Driven type). FEI<sub>t</sub> / FEI<sub>s</sub> values for fans with specific motors will vary slightly from those shown.



Model: AXV 900-250-14

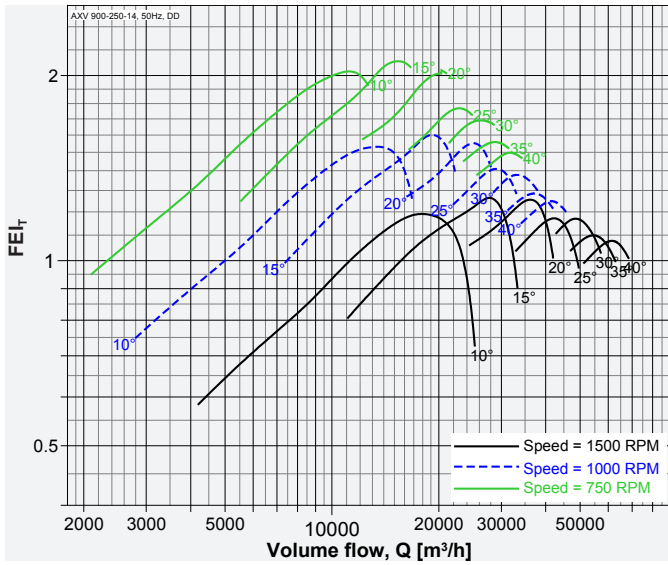

Model: AXV 900-300-10

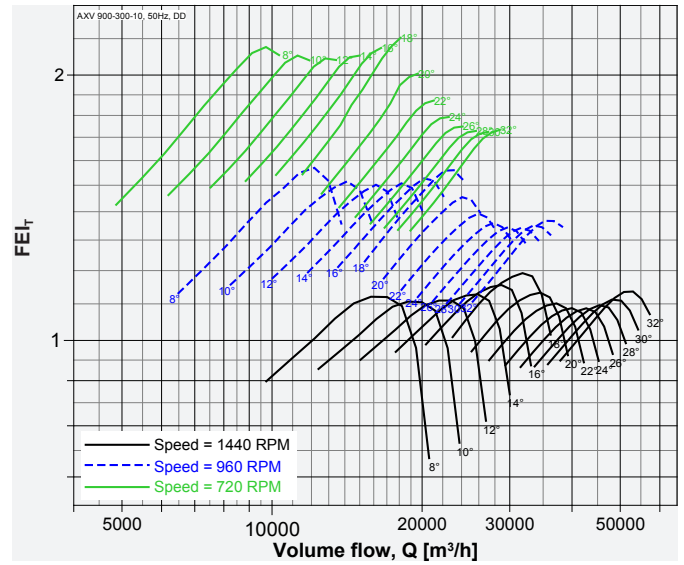

Model: AXV 1000-250-7

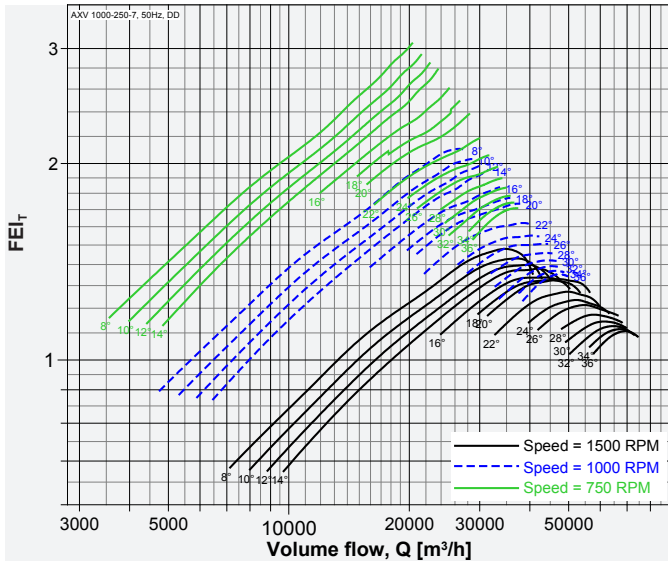

Model: AXV 1000-250-14

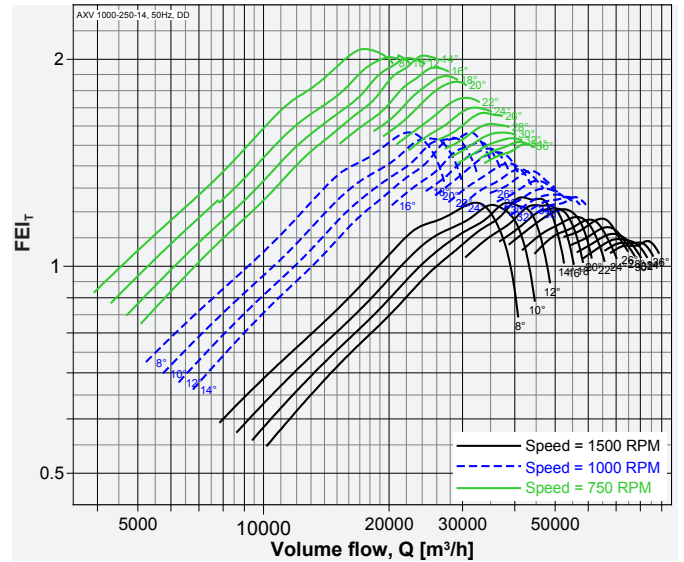

Model: AXV 1000-300-10

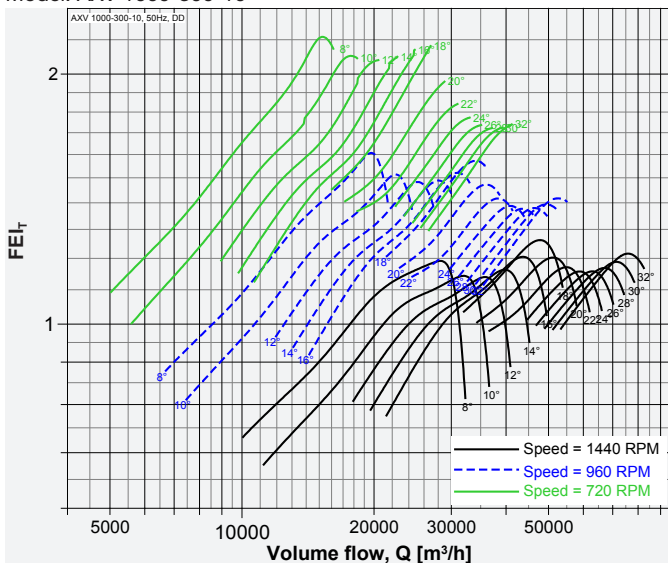

Model: AXV 1120-300-5

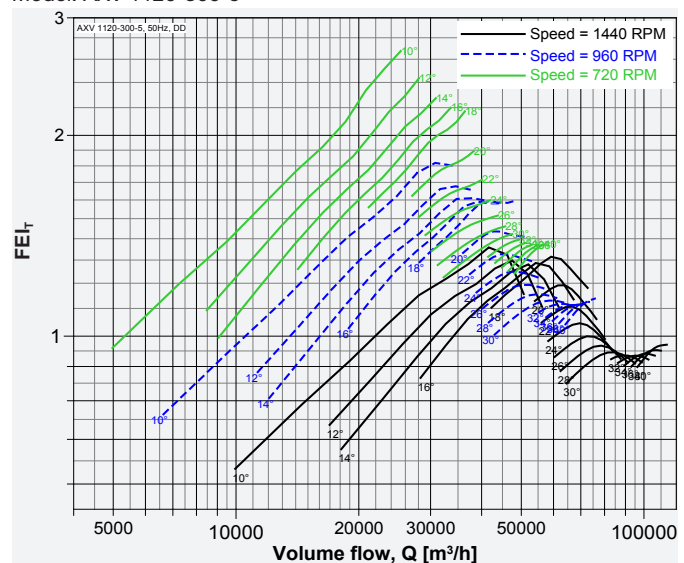

Performance of size 250 to 1250 certified is for installation type D - Ducted inlet, Ducted outlet, Performance of size 1400 to 2800 certified is for installation type A - Free inlet, Free outlet. Power rating (kW) does not include transmission losses. Performance ratings do not include the effects of appurtenances (accessories-belt cover, pulley & belt). FEI<sub>t</sub> / FEI<sub>s</sub> values are calculated in accordance with ANSI/AMCA Standard 208 and are based on default motor efficiencies (Direct Driven type). FEI<sub>t</sub> / FEI<sub>s</sub> values for fans with specific motors will vary slightly from those shown.



Model: AXV 1250-370-6

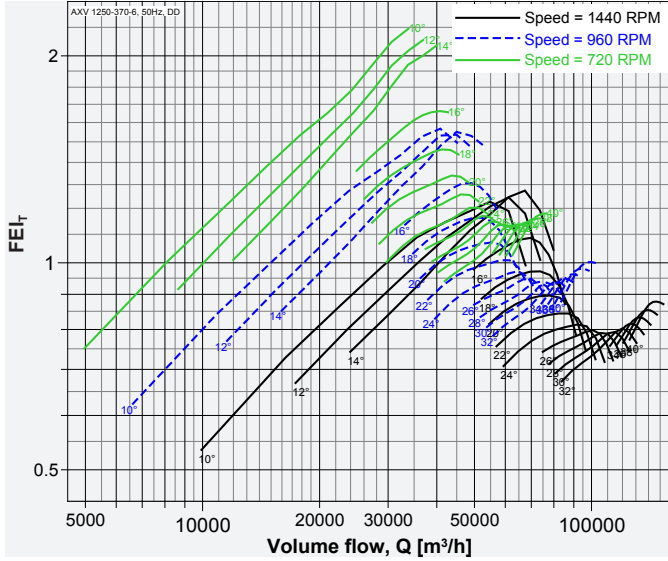

Model: AXV 1400-420-6

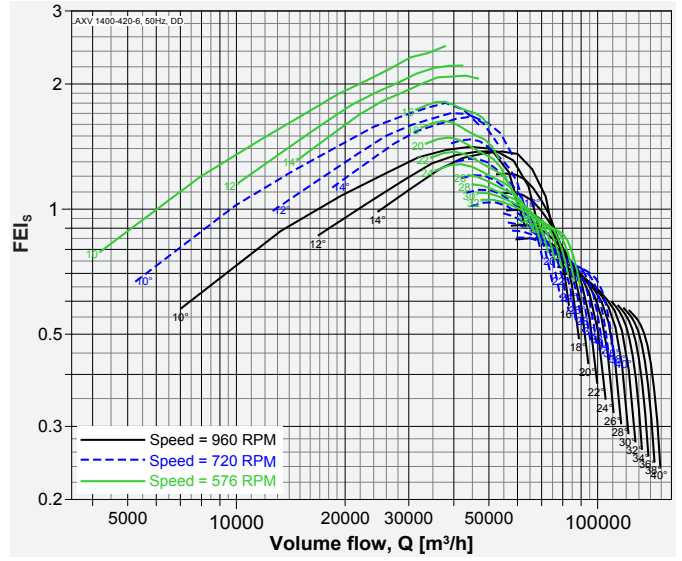

Model: AXV 1600-420-6

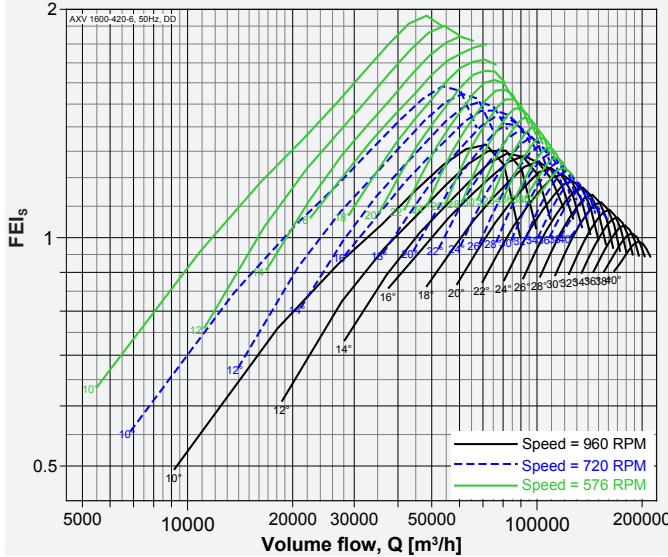

Model: AXV 1800-540-6

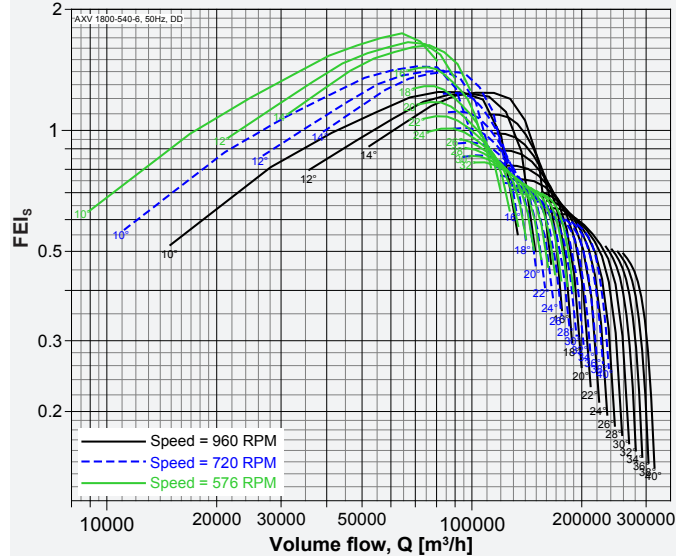

Model: AXV 2000-600-6

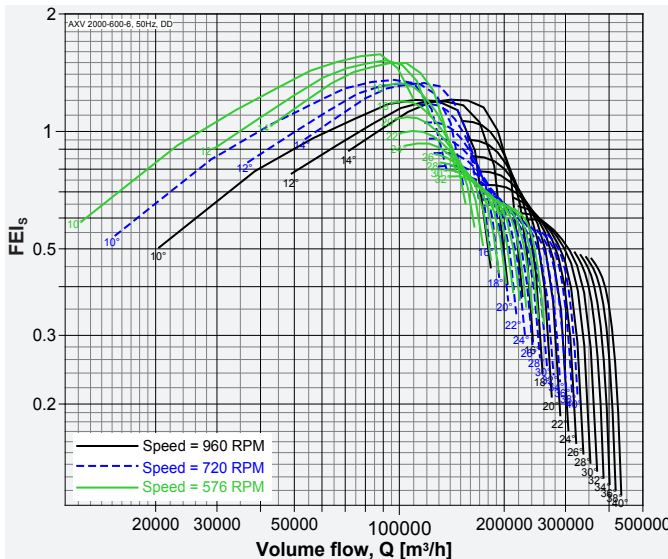

Model: AXV 2200-660-6

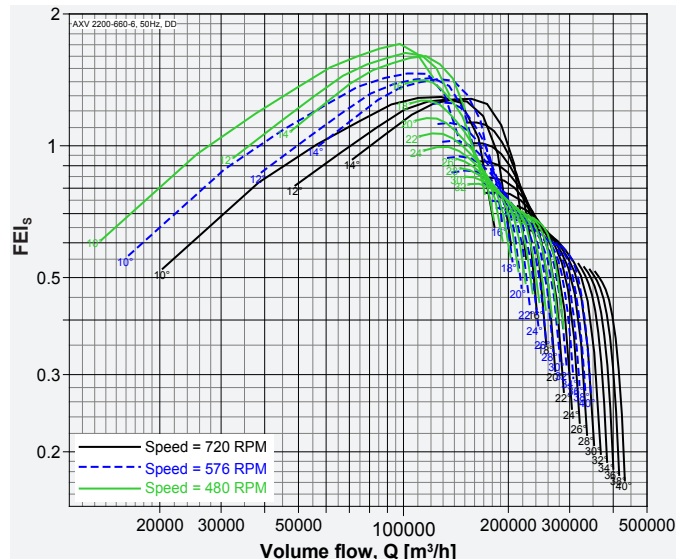

Performance of size 250 to 1250 certified is for installation type D - Ducted inlet, Ducted outlet, Performance of size 1400 to 2800 certified is for installation type A - Free inlet, Free outlet. Power rating (kW) does not include transmission losses. Performance ratings do not include the effects of appurtenances (accessories-belt cover, pulley & belt). FEI<sub>T</sub> / FEI<sub>S</sub> values are calculated in accordance with ANSI/AMCA Standard 208 and are based on default motor efficiencies (Direct Driven type). FEI<sub>T</sub> / FEI<sub>S</sub> values for fans with specific motors will vary slightly from those shown.



Model: AXV 2400-720-6

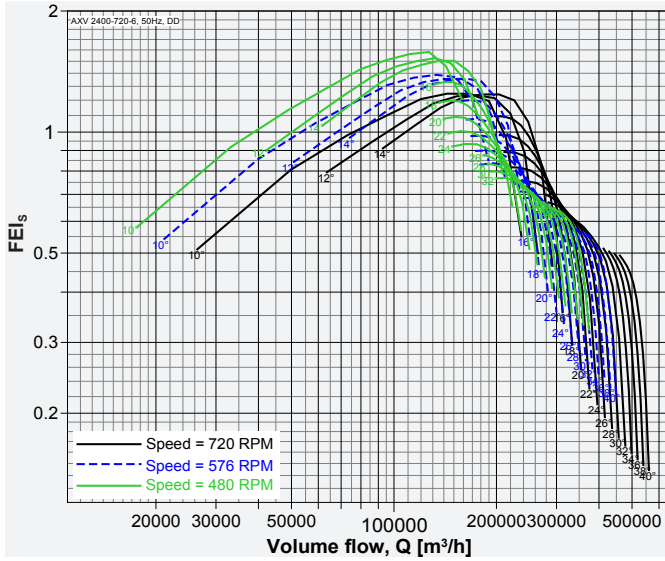

Model: AXV 2500-750-6

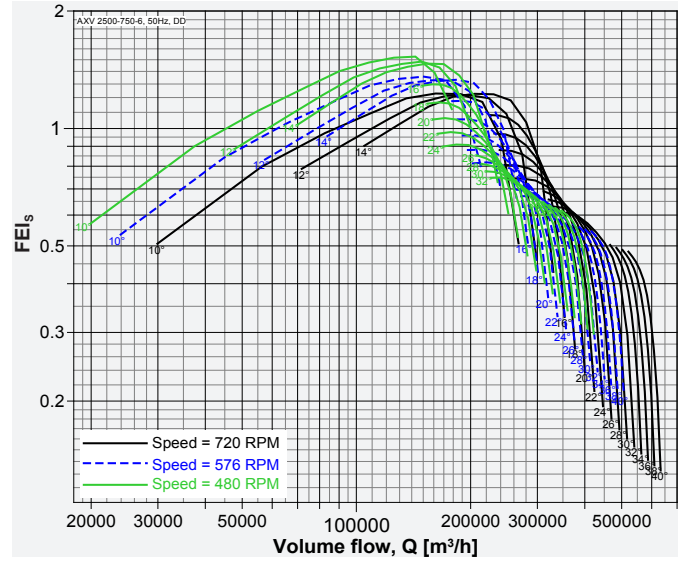

Model: AXV 2600-780-6

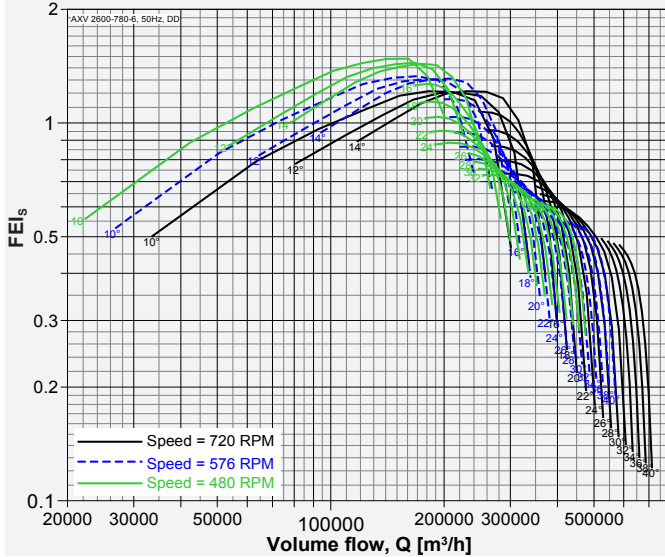

Model: AXV 2800-840-6

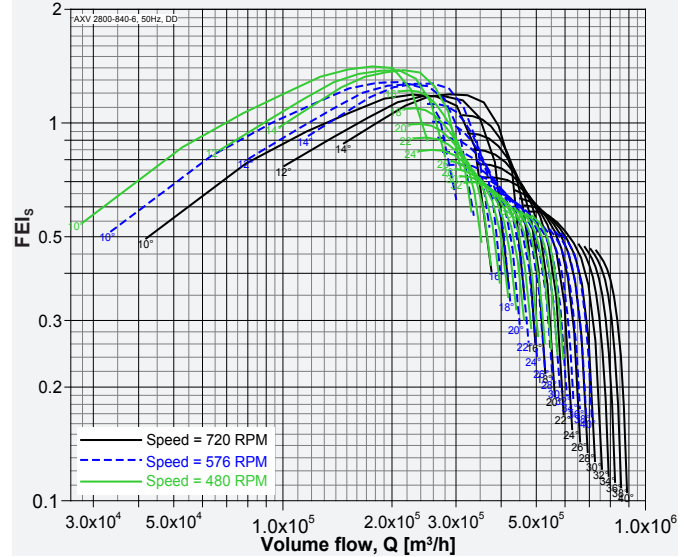

Performance of size 250 to 1250 certified is for installation type D - Ducted inlet, Ducted outlet, Performance of size 1400 to 2800 certified is for installation type A - Free inlet, Free outlet. Power rating (kW) does not include transmission losses. Performance ratings do not include the effects of appurtenances (accessories-belt cover, pulley & belt).  $FEI_1$  /  $FEI_s$  values are calculated in accordance with ANSI/AMCA Standard 208 and are based on default motor efficiencies (Direct Driven type).  $FEI_1$  /  $FEI_s$  values for fans with specific motors will vary slightly from those shown.



Belt Driven Models, Size from 250 to 2800, 50Hz

Model: AXV 250-110-3

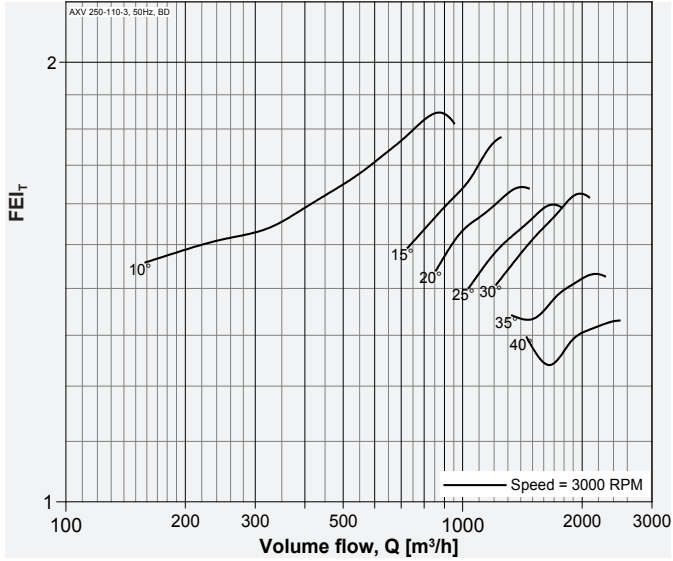

Model: AXV 250-110-6

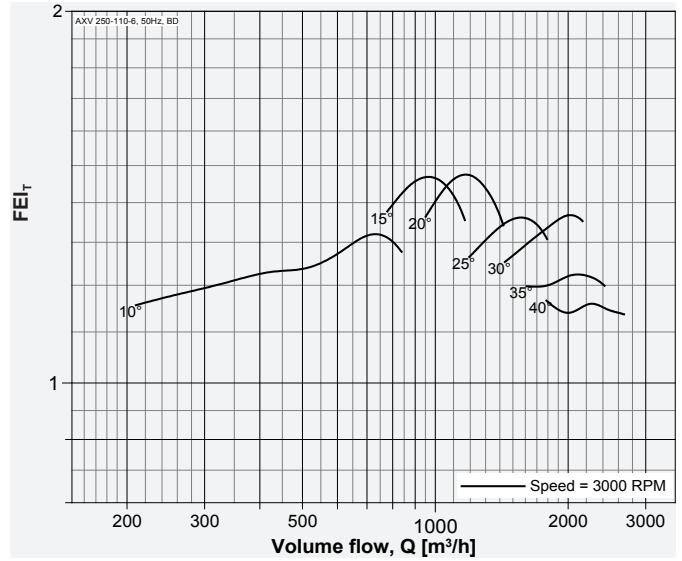

Model: AXV 280-110-3

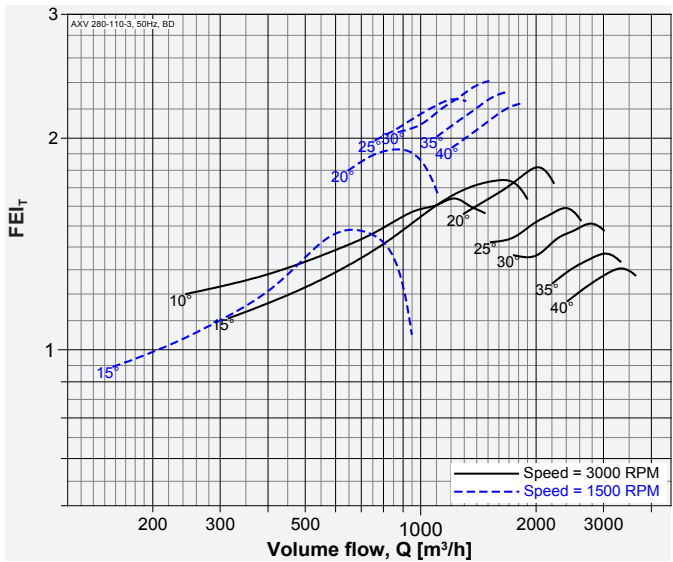

Model: AXV 280-110-6

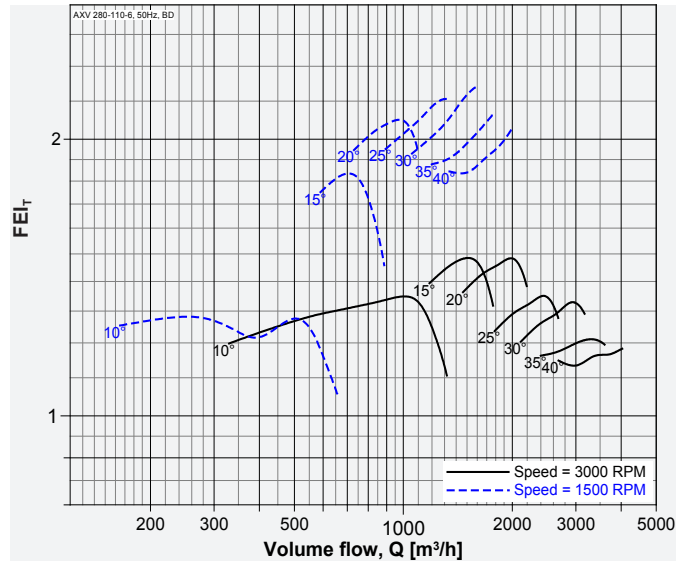

Model: AXV 315-110-3

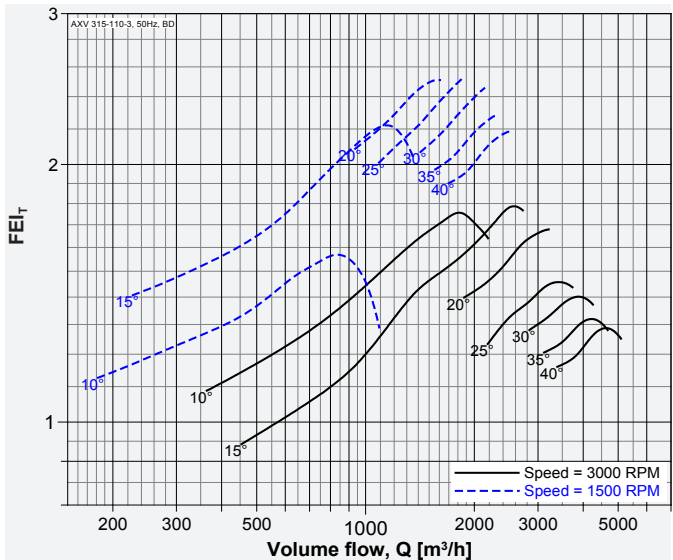

Model: AXV 315-110-6

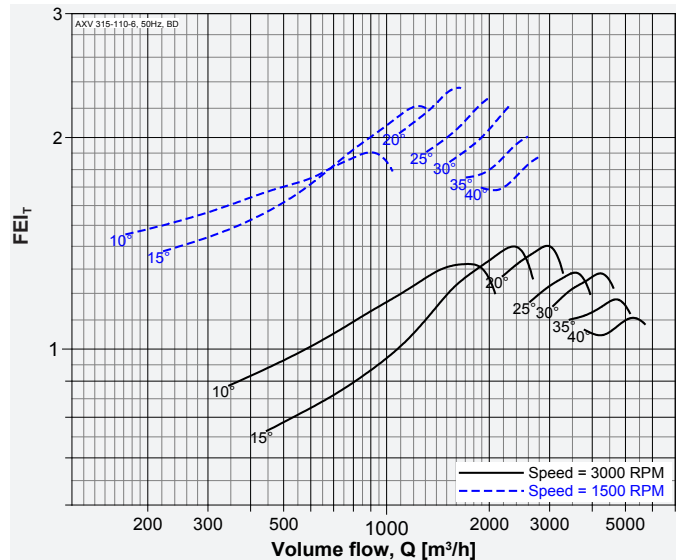

Performance of size 250 to 1250 certified is for installation type D - Ducted inlet, Ducted outlet, Performance of size 1400 to 2800 certified is for installation type A - Free inlet, Free outlet. Power rating (kW) does not include transmission losses. Performance ratings do not include the effects of appurtenances (accessories-belt cover, pulley & belt). FEI<sub>T</sub> / FEI<sub>S</sub> values are calculated in accordance with ANSI/AMCA Standard 208 and are based on default motor efficiencies (Belt Driven type). FEI<sub>T</sub> / FEI<sub>S</sub> values for fans with specific motors will vary slightly from those shown.



Model: AXV 355-110-3

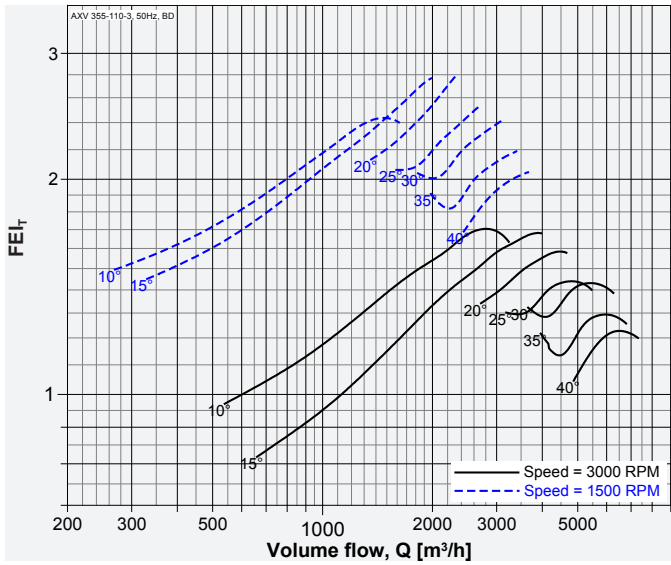

Model: AXV 355-110-6

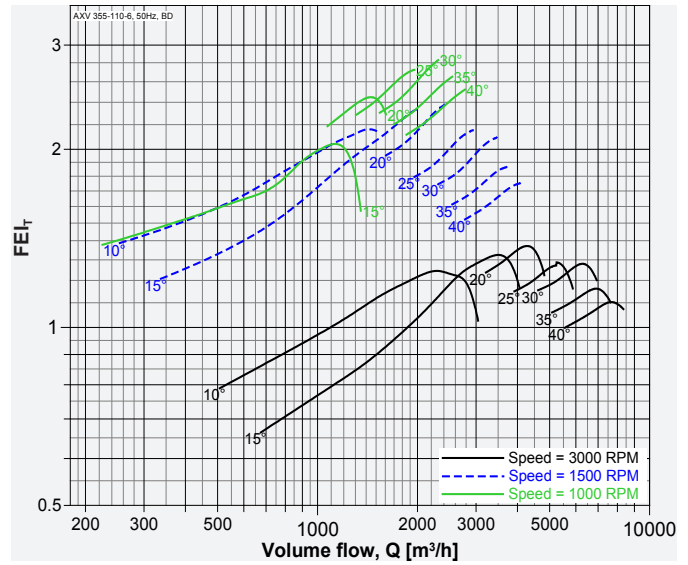

Model: AXV 355-150-7

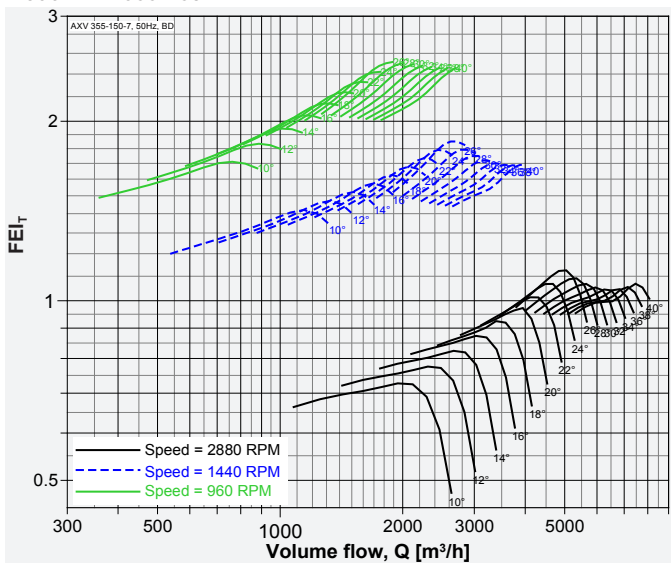

Model: AXV 400-110-3

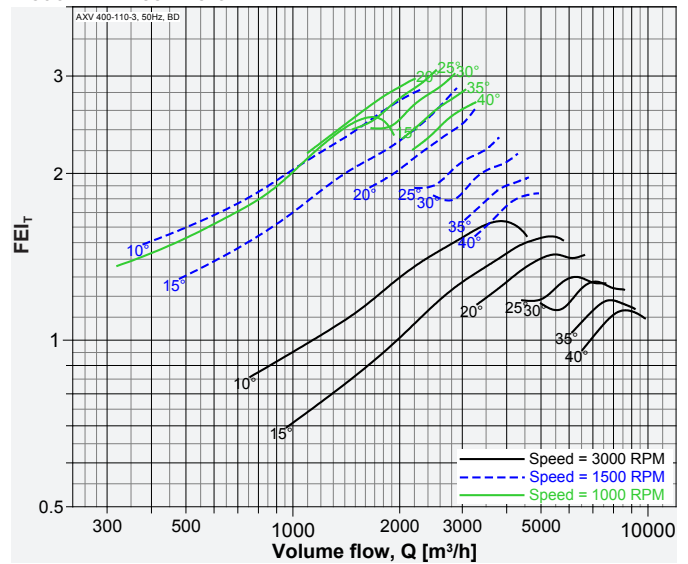

Model: AXV 400-110-6

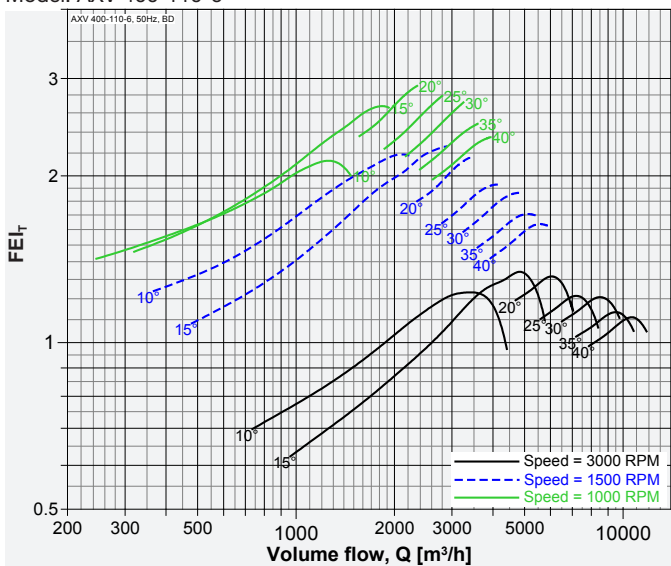

Model: AXV 400-150-5

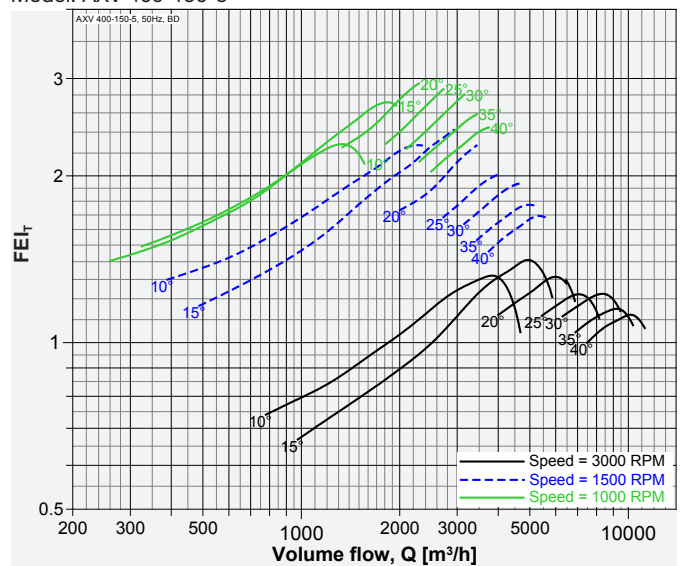

Performance of size 250 to 1250 certified is for installation type D - Ducted inlet, Ducted outlet, Performance of size 1400 to 2800 certified is for installation type A - Free inlet, Free outlet. Power rating (kW) does not include transmission losses. Performance ratings do not include the effects of appurtenances (accessories-belt cover, pulley & belt). FEI<sub>t</sub> / FEI<sub>s</sub> values are calculated in accordance with ANSI/AMCA Standard 208 and are based on default motor efficiencies (Belt Driven type). FEI<sub>t</sub> / FEI<sub>s</sub> values for fans with specific motors will vary slightly from those shown.





Model: AXV 400-150-7

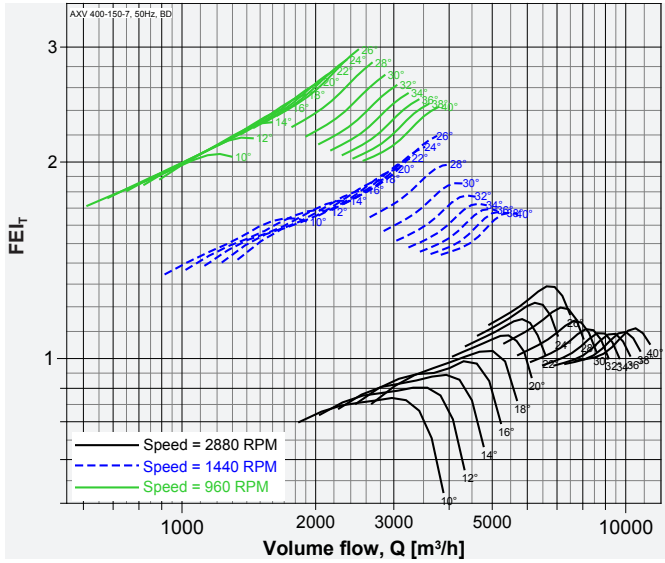

Model: AXV 400-150-10

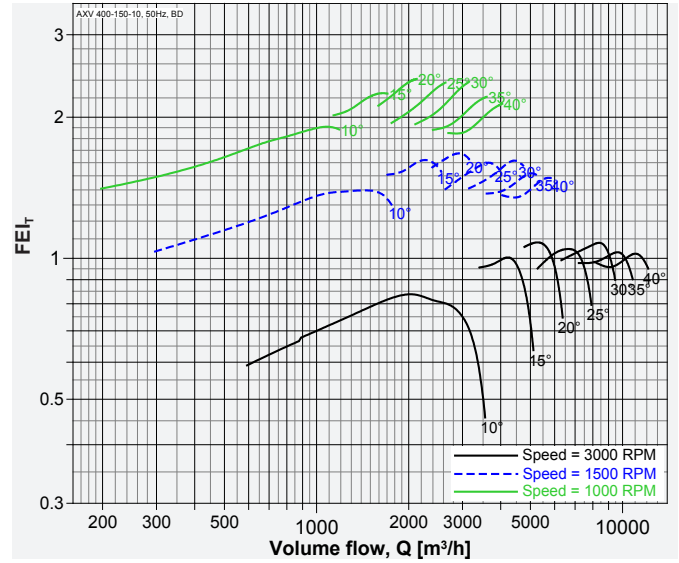

Model: AXV 450-110-3

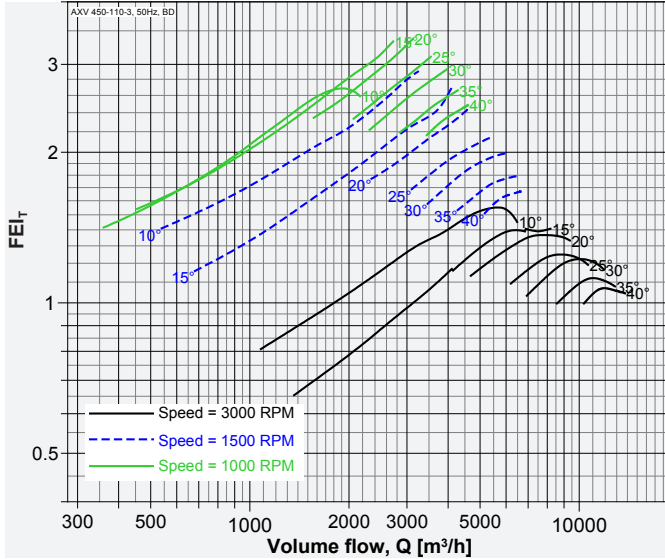

Model: AXV 450-110-6

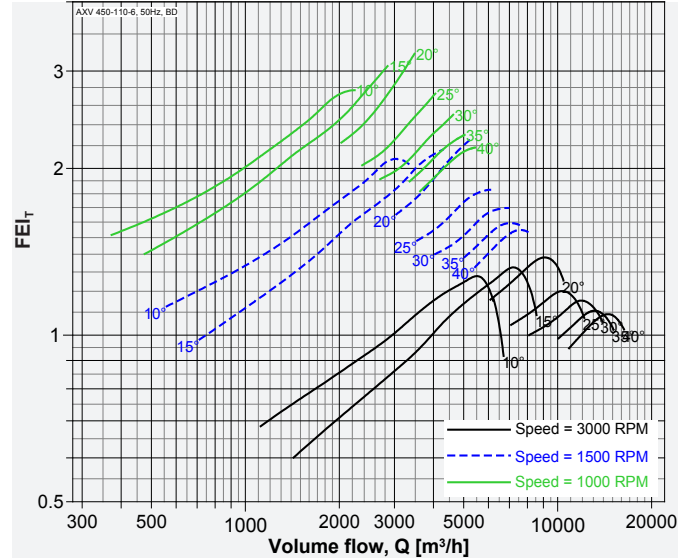

Model: AXV 450-150-5

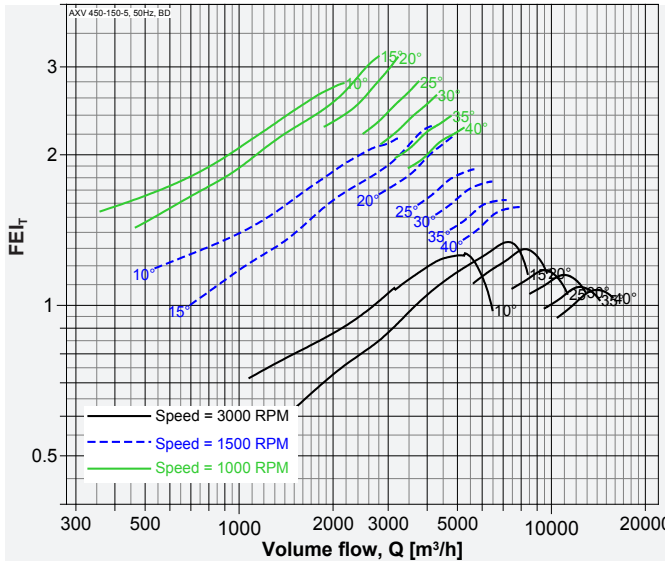

Model: AXV 450-150-7

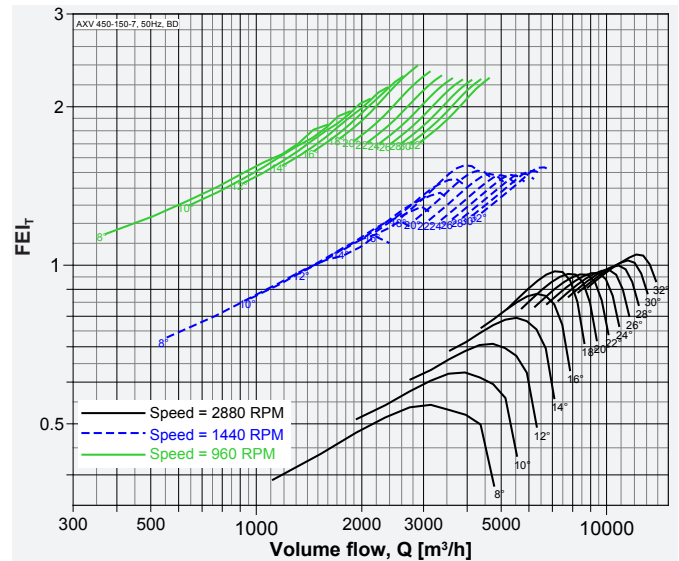

Performance of size 250 to 1250 certified is for installation type D - Ducted inlet, Ducted outlet, Performance of size 1400 to 2800 certified is for installation type A - Free inlet, Free outlet. Power rating (kW) does not include transmission losses. Performance ratings do not include the effects of appurtenances (accessories-belt cover, pulley & belt). FEI<sub>T</sub> / FEI<sub>S</sub> values are calculated in accordance with ANSI/AMCA Standard 208 and are based on default motor efficiencies (Belt Driven type). FEI<sub>T</sub> / FEI<sub>S</sub> values for fans with specific motors will vary slightly from those shown.



Model: AXV 450-150-10

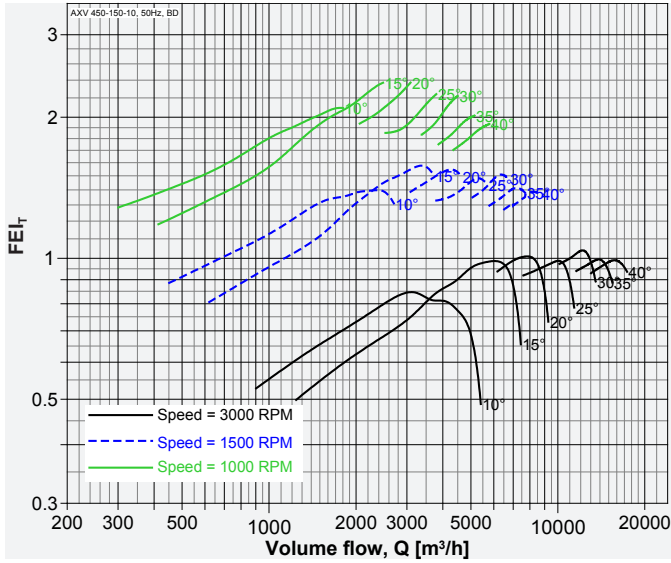

Model: AXV 500-110-3

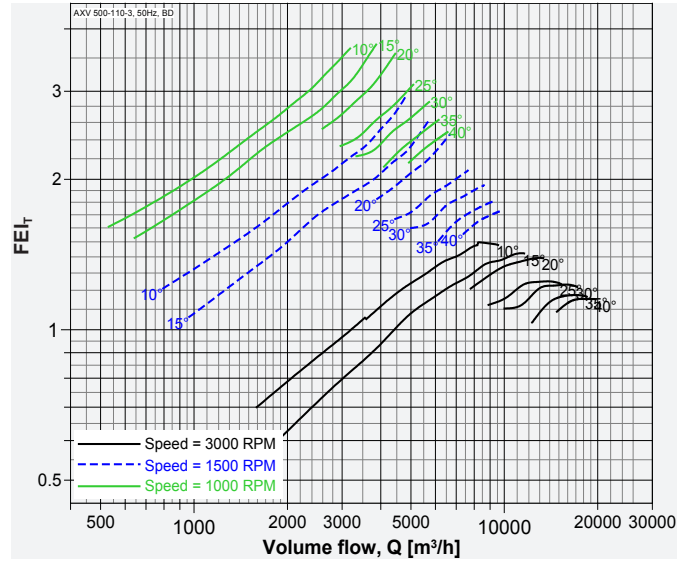

Model: AXV 500-110-6

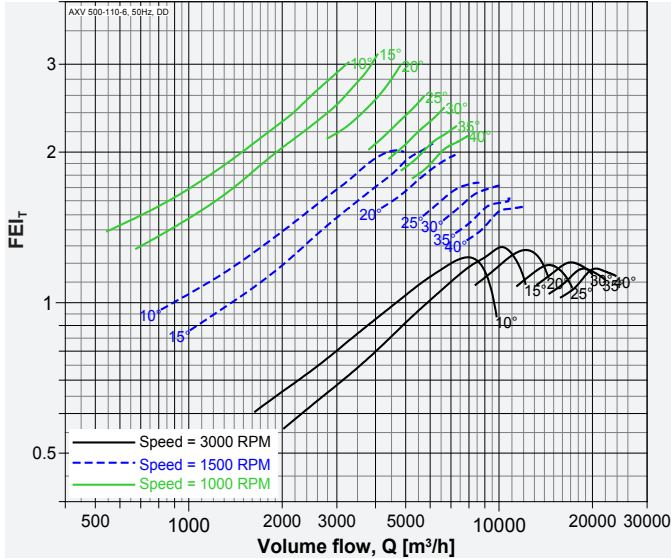

Model: AXV 500-150-5

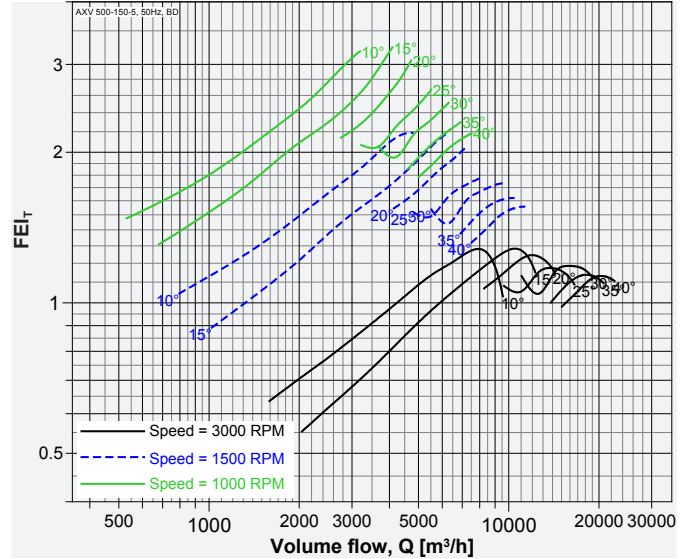

Model: AXV 500-150-7

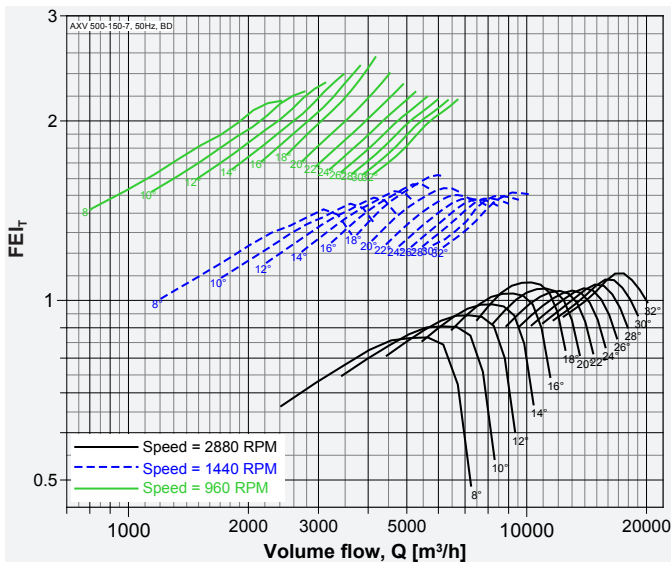

Model: AXV 500-150-10

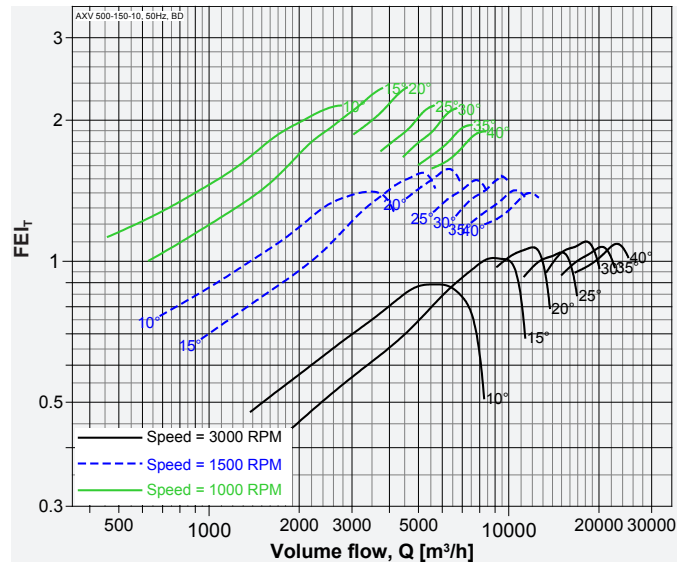

Performance of size 250 to 1250 certified is for installation type D - Ducted inlet, Ducted outlet, Performance of size 1400 to 2800 certified is for installation type A - Free inlet, Free outlet. Power rating (kW) does not include transmission losses. Performance ratings do not include the effects of appurtenances (accessories-belt cover, pulley & belt). FEI<sub>t</sub> / FEI<sub>s</sub> values are calculated in accordance with ANSI/AMCA Standard 208 and are based on default motor efficiencies (Belt Driven type). FEI<sub>t</sub> / FEI<sub>s</sub> values for fans with specific motors will vary slightly from those shown.



Model: AXV 500-250-7

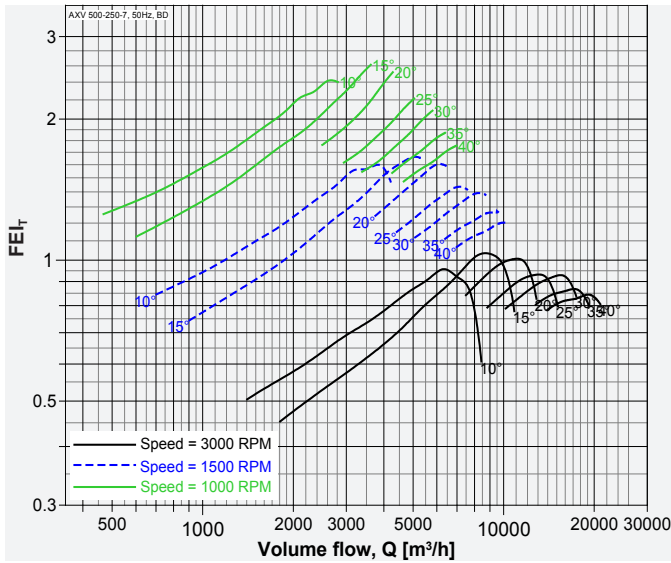

Model: AXV 560-110-3

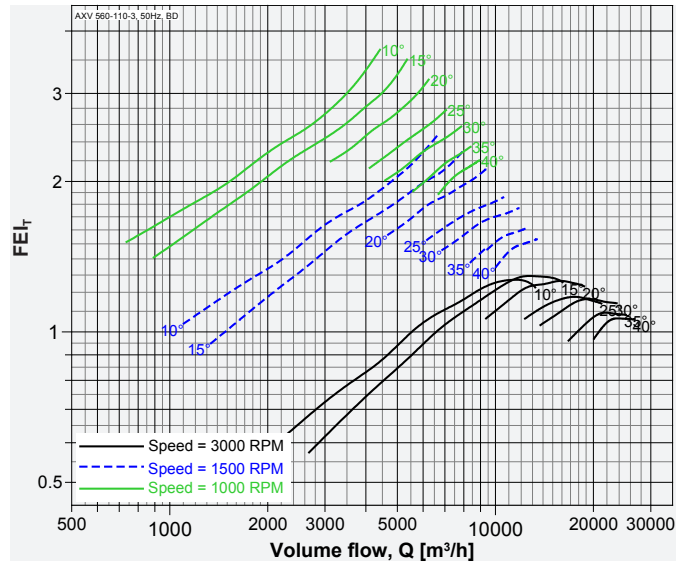

Model: AXV 560-110-6

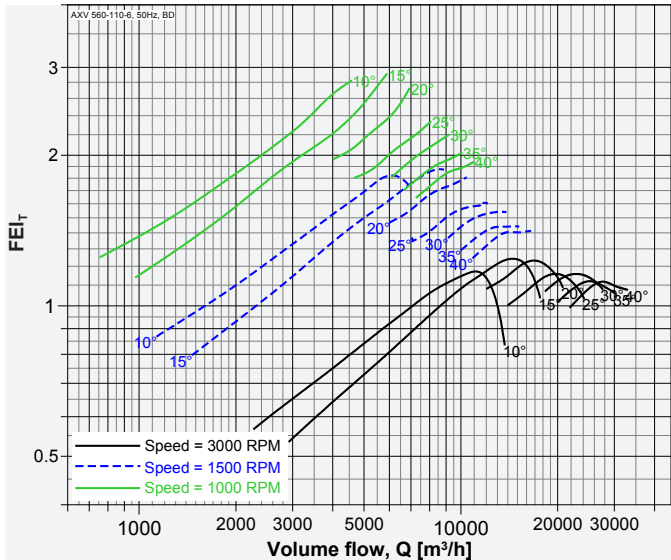

Model: AXV 560-150-5

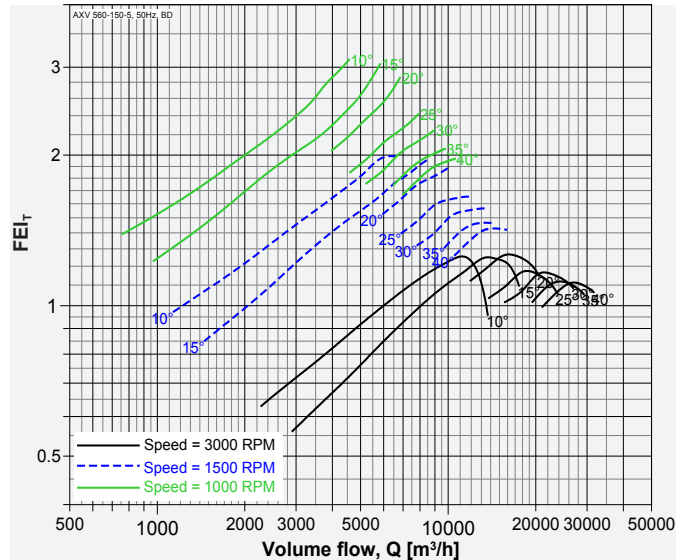

Model: AXV 560-150-10

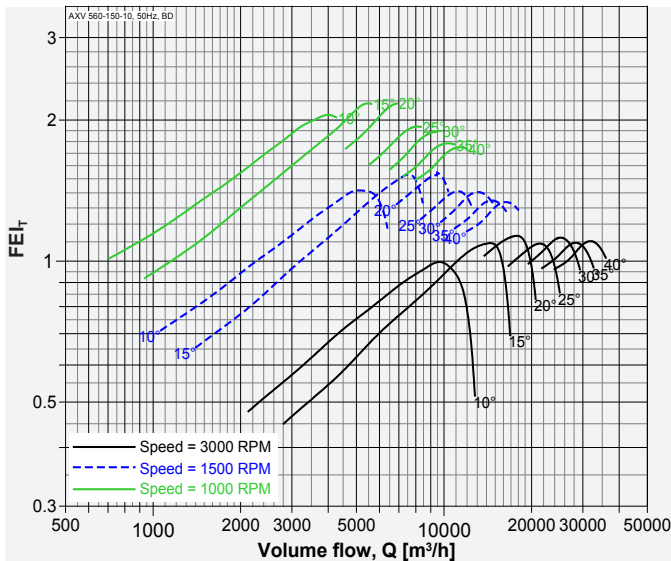

Model: AXV 560-200-9

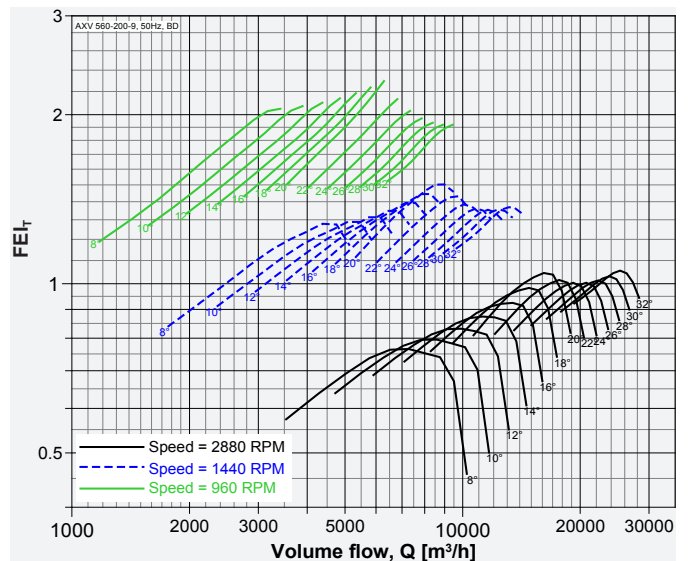

Performance of size 250 to 1250 certified is for installation type D - Ducted inlet, Ducted outlet, Performance of size 1400 to 2800 certified is for installation type A - Free inlet, Free outlet. Power rating (kW) does not include transmission losses. Performance ratings do not include the effects of appurtenances (accessories-belt cover, pulley & belt). FEI<sub>T</sub> / FEI<sub>S</sub> values are calculated in accordance with ANSI/AMCA Standard 208 and are based on default motor efficiencies (Belt Driven type). FEI<sub>T</sub> / FEI<sub>S</sub> values for fans with specific motors will vary slightly from those shown.



Model: AXV 560-250-7

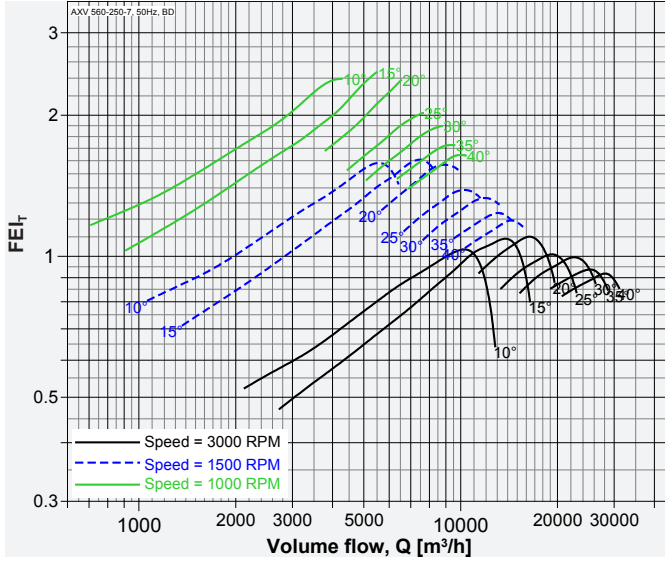

Model: AXV 560-250-14

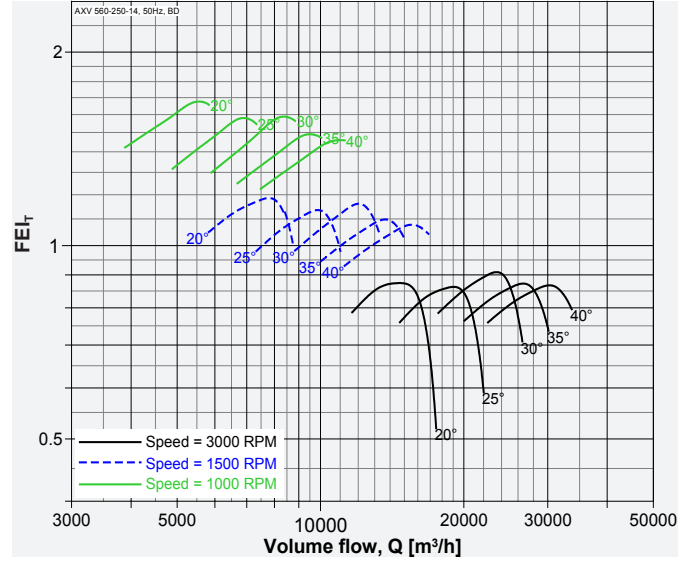

Model: AXV 630-110-3

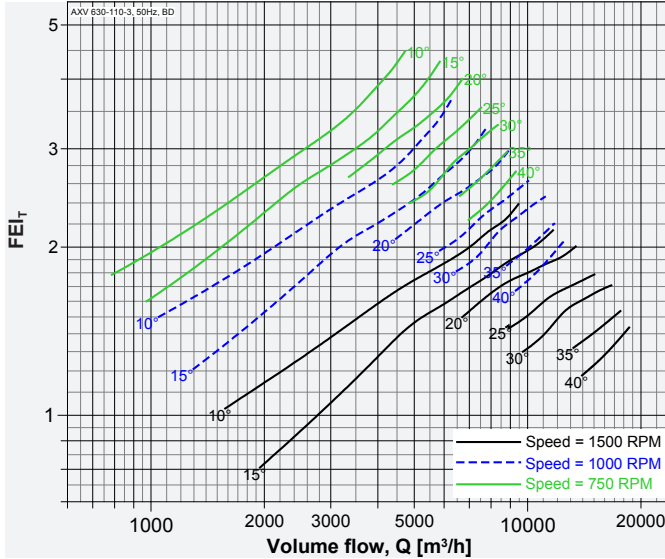

Model: AXV 630-110-6

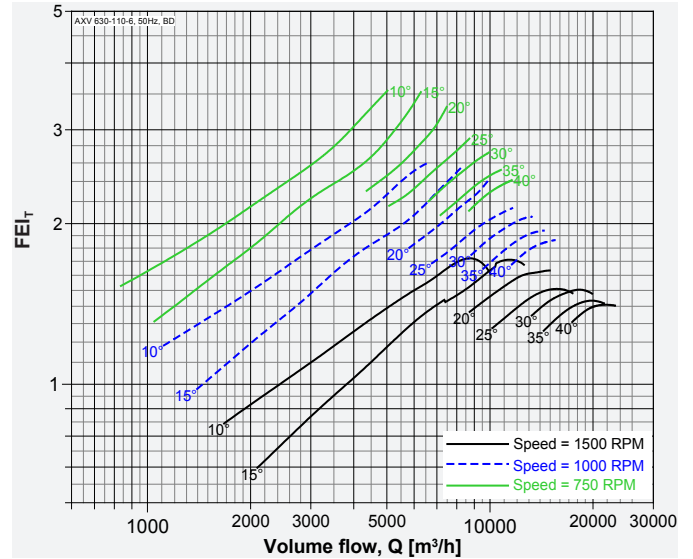

Model: AXV 630-150-5

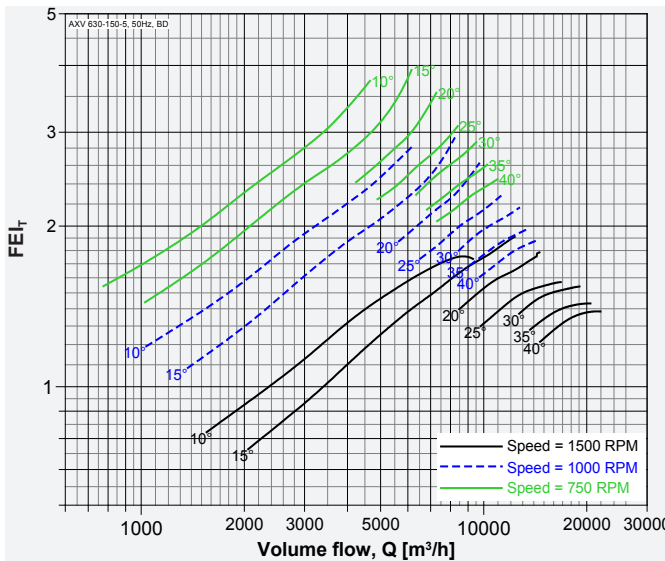

Model: AXV 630-150-10

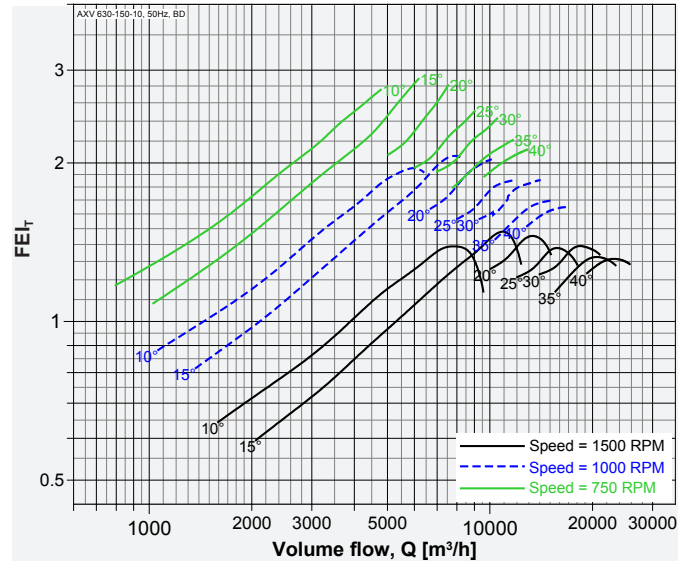

Performance of size 250 to 1250 certified is for installation type D - Ducted inlet, Ducted outlet, Performance of size 1400 to 2800 certified is for installation type A - Free inlet, Free outlet. Power rating (kW) does not include transmission losses. Performance ratings do not include the effects of appurtenances (accessories-belt cover, pulley & belt). FEI<sub>t</sub> / FEI<sub>s</sub> values are calculated in accordance with ANSI/AMCA Standard 208 and are based on default motor efficiencies (Belt Driven type). FEI<sub>t</sub> / FEI<sub>s</sub> values for fans with specific motors will vary slightly from those shown.



Model: AXV 630-200-9

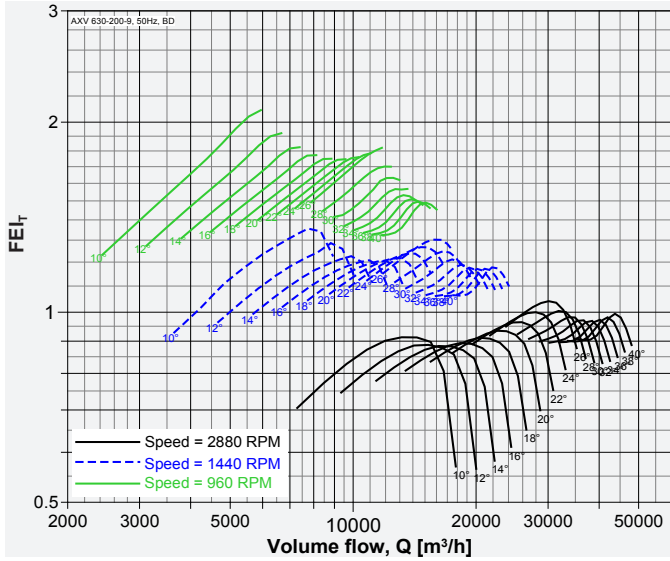

Model: AXV 630-250-7

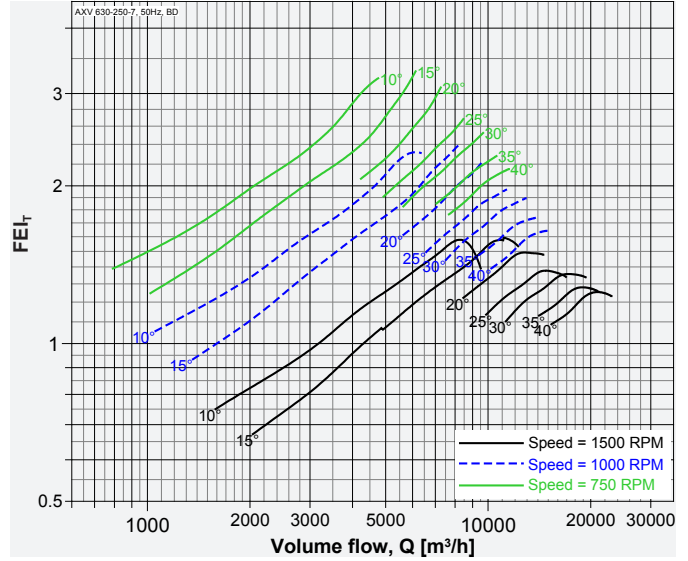

Model: AXV 630-250-14

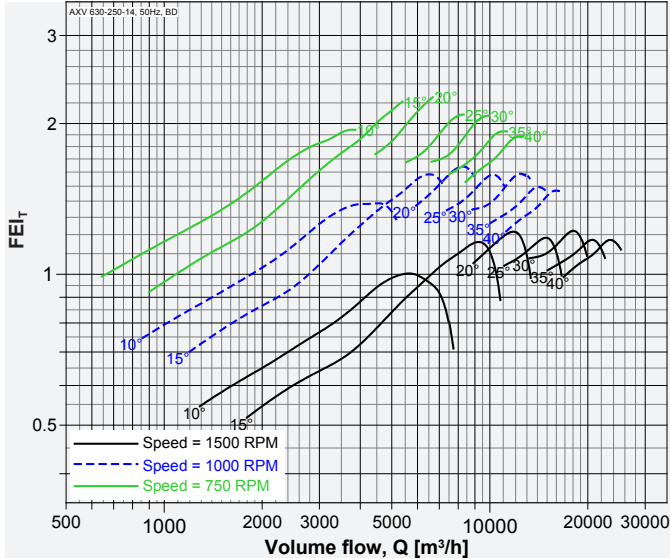

Model: AXV 710-110-3

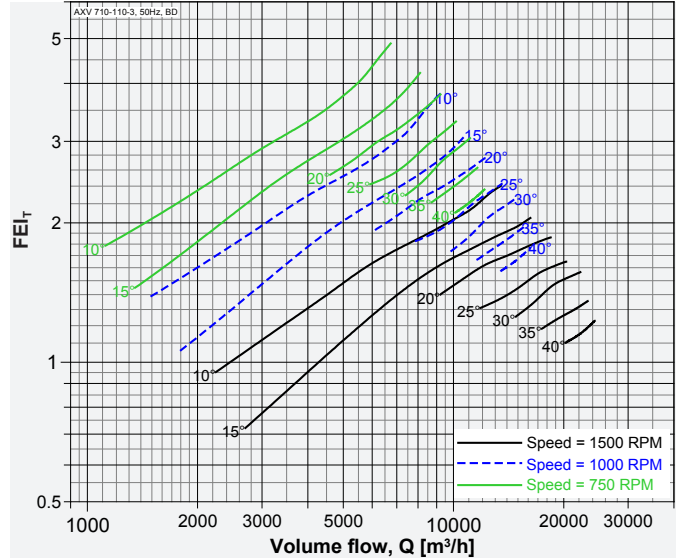

Model: AXV 710-110-6

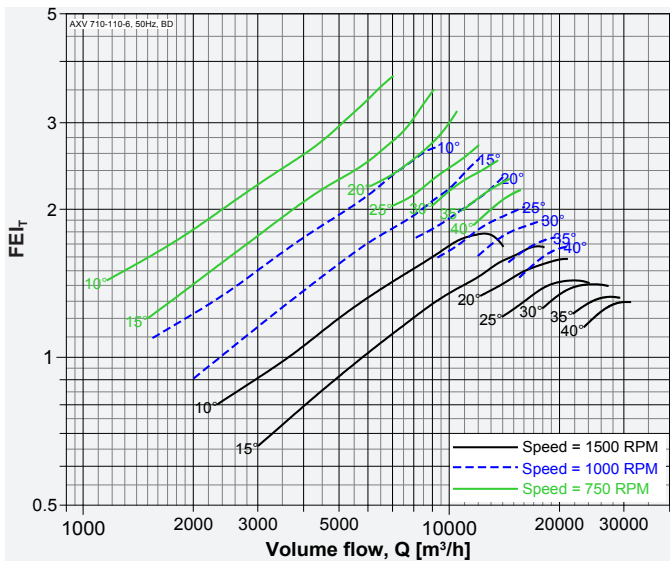

Model: AXV 710-150-5

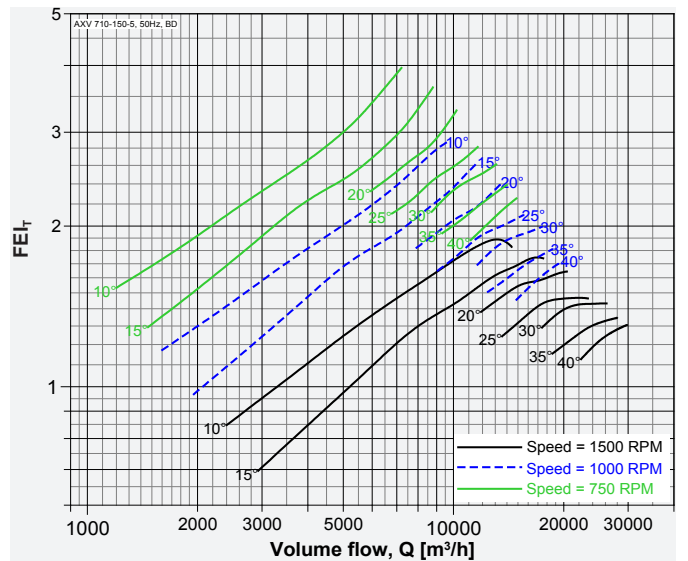

Performance of size 250 to 1250 certified is for installation type D - Ducted inlet, Ducted outlet, Performance of size 1400 to 2800 certified is for installation type A - Free inlet, Free outlet. Power rating (kW) does not include transmission losses. Performance ratings do not include the effects of appurtenances (accessories-belt cover, pulley & belt). FEI<sub>T</sub> / FEI<sub>S</sub> values are calculated in accordance with ANSI/AMCA Standard 208 and are based on default motor efficiencies (Belt Driven type). FEI<sub>T</sub> / FEI<sub>S</sub> values for fans with specific motors will vary slightly from those shown.



Model: AXV 710-150-10

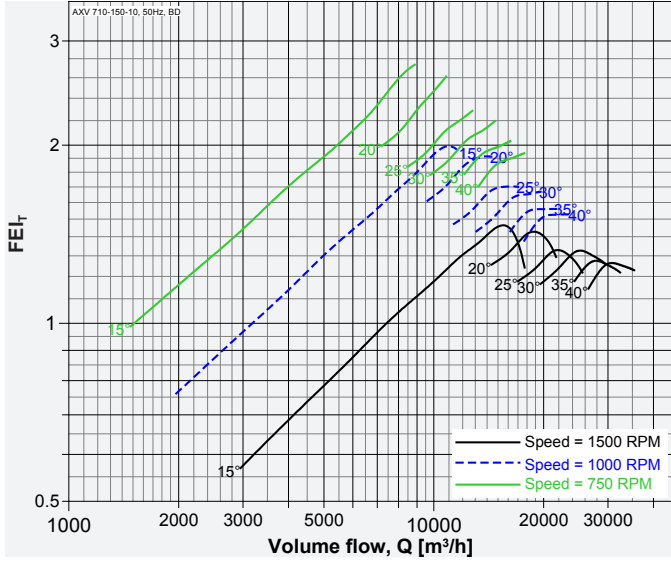

Model: AXV 710-250-7

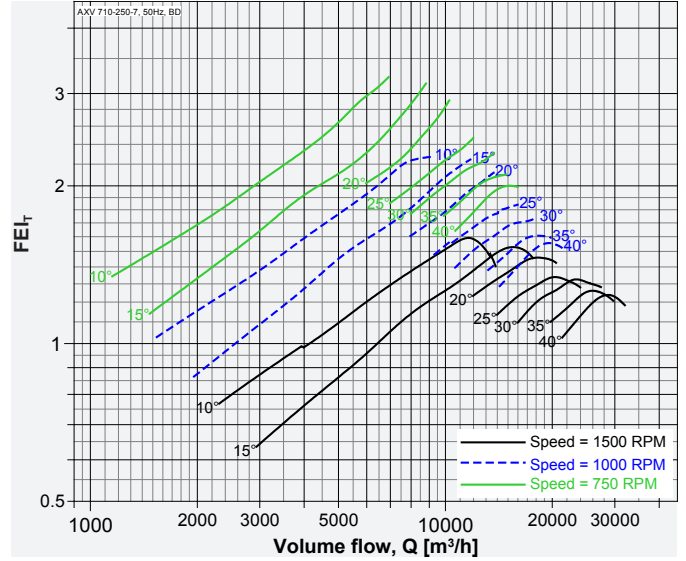

Model: AXV 710-250-9

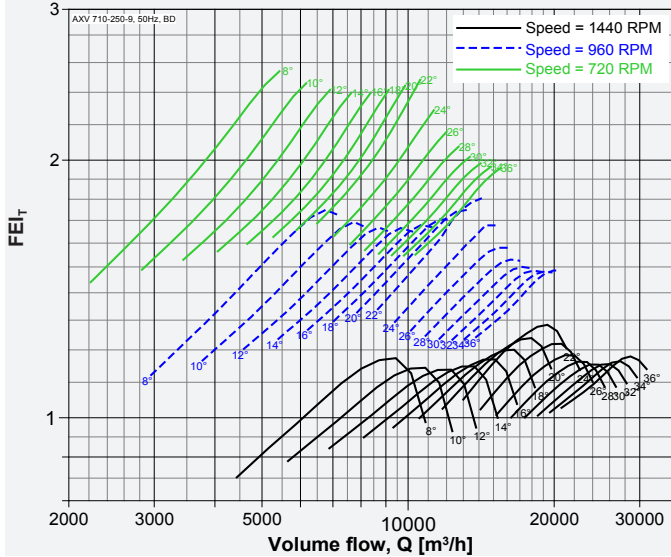

Model: AXV 710-250-14

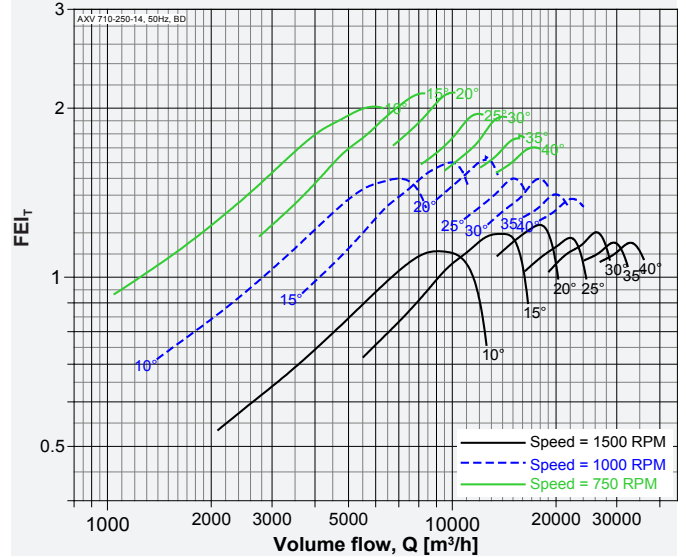

Model: AXV 800-150-5

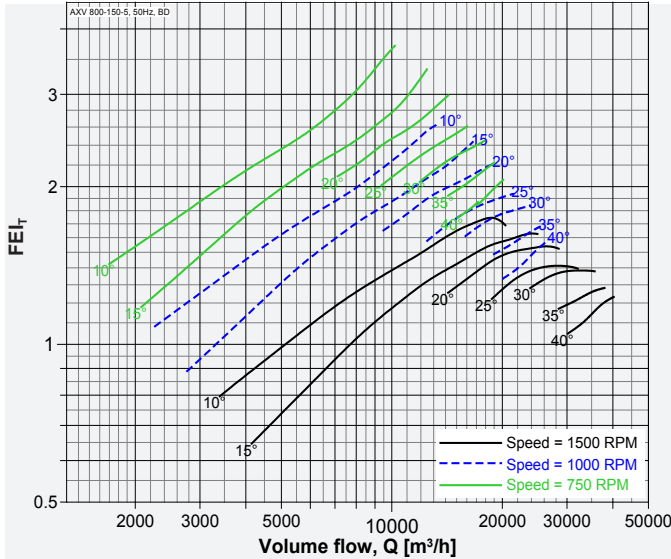

Model: AXV 800-150-10

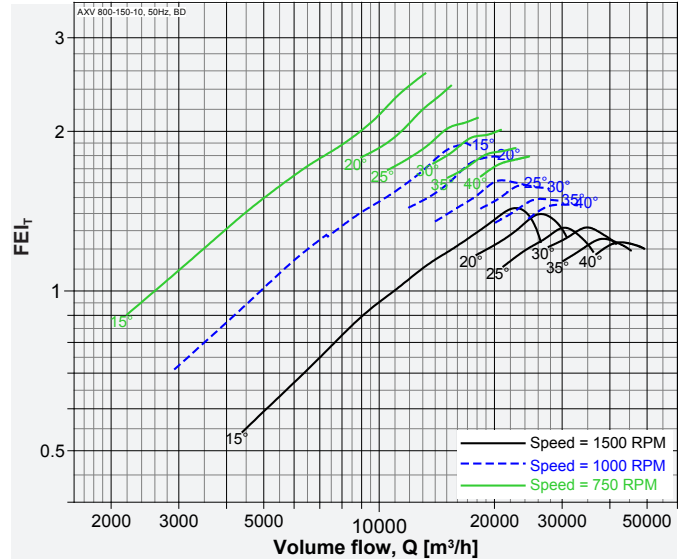

Performance of size 250 to 1250 certified is for installation type D - Ducted inlet, Ducted outlet, Performance of size 1400 to 2800 certified is for installation type A - Free inlet, Free outlet. Power rating (kW) does not include transmission losses. Performance ratings do not include the effects of appurtenances (accessories-belt cover, pulley & belt). FEI<sub>t</sub> / FEI<sub>s</sub> values are calculated in accordance with ANSI/AMCA Standard 208 and are based on default motor efficiencies (Belt Driven type). FEI<sub>t</sub> / FEI<sub>s</sub> values for fans with specific motors will vary slightly from those shown.



Model: AXV 800-250-7

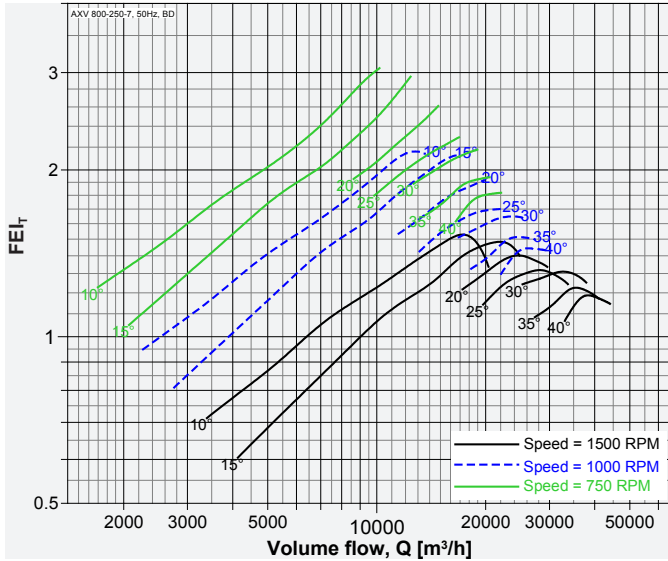

Model: AXV 800-250-9

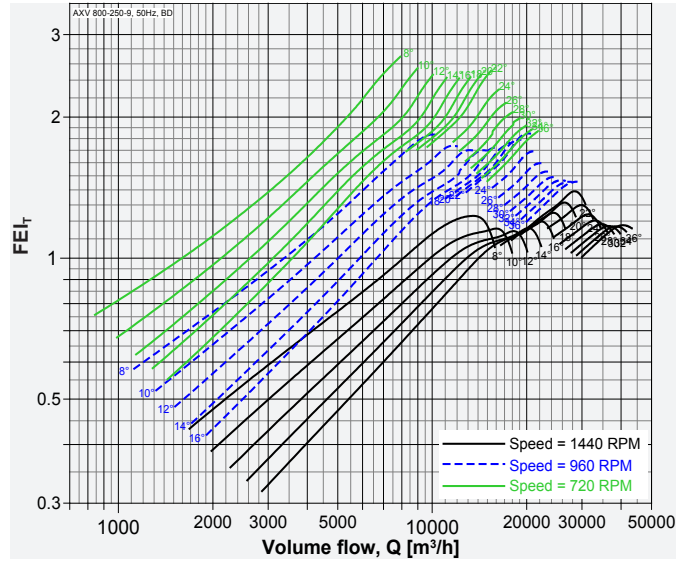

Model: AXV 800-250-14

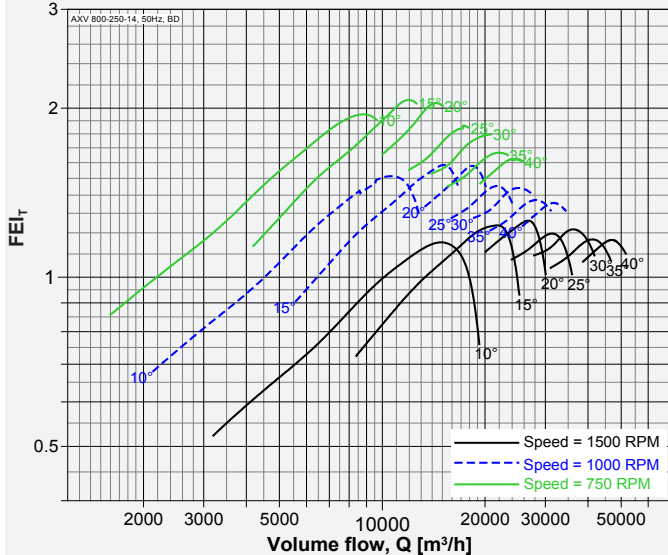

Model: AXV 900-250-7

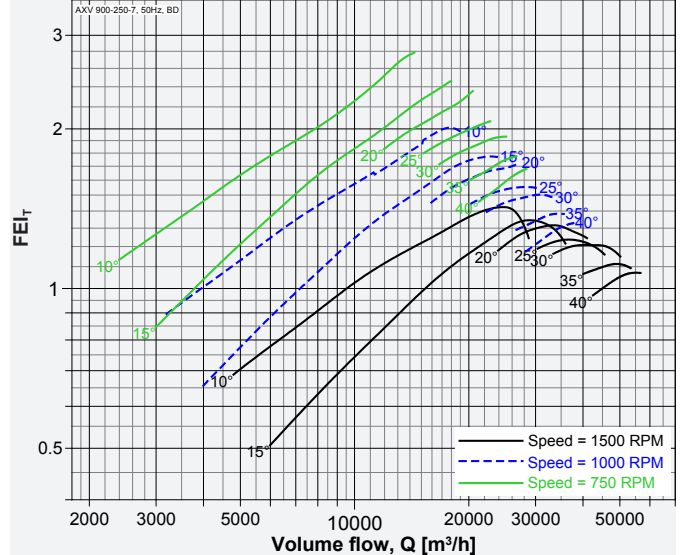

Model: AXV 900-250-14

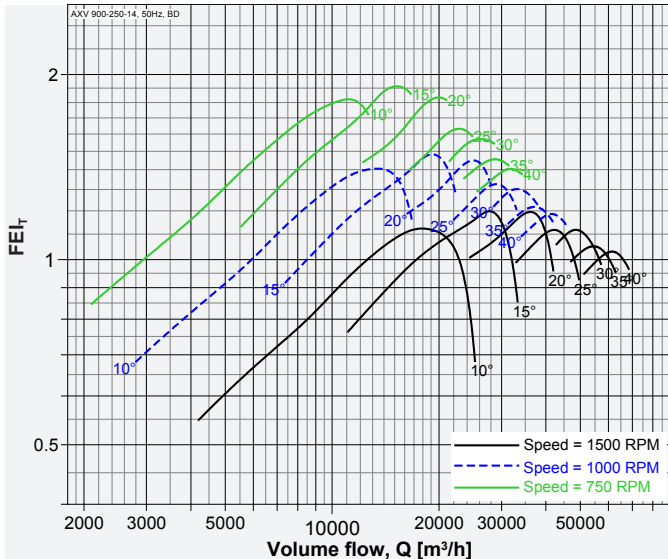

Model: AXV 900-300-10

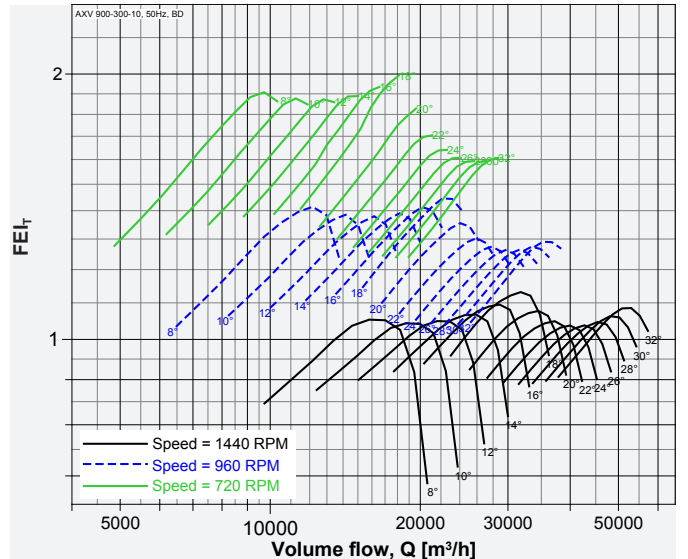

Performance of size 250 to 1250 certified is for installation type D - Ducted inlet, Ducted outlet, Performance of size 1400 to 2800 certified is for installation type A - Free inlet, Free outlet. Power rating (kW) does not include transmission losses. Performance ratings do not include the effects of appurtenances (accessories-belt cover, pulley & belt). FEI<sub>T</sub> / FEI<sub>S</sub> values are calculated in accordance with ANSI/AMCA Standard 208 and are based on default motor efficiencies (Belt Driven type). FEI<sub>T</sub> / FEI<sub>S</sub> values for fans with specific motors will vary slightly from those shown.



Model: AXV 1000-250-7

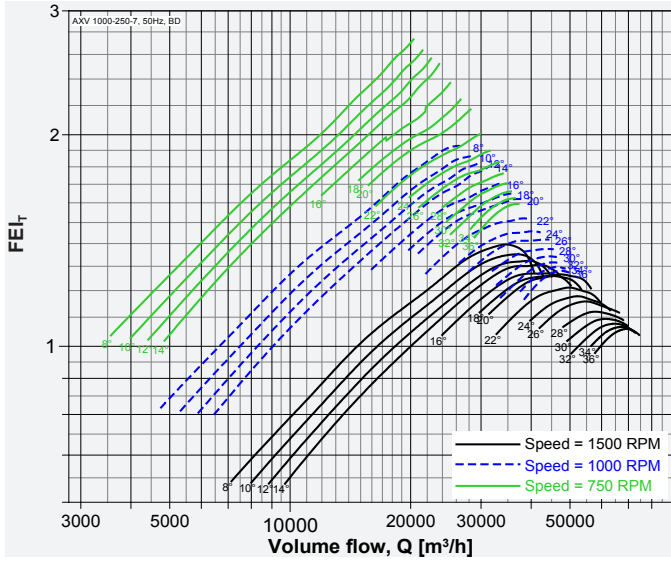

Model: AXV 1000-250-14

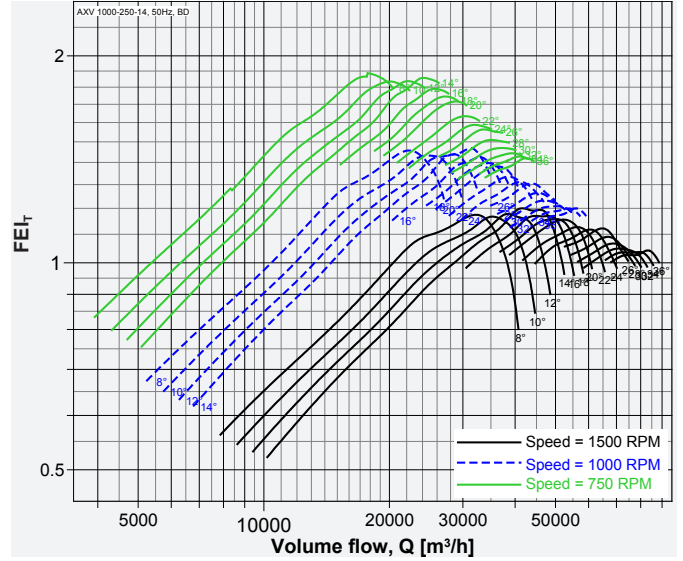

Model: AXV 1000-300-10

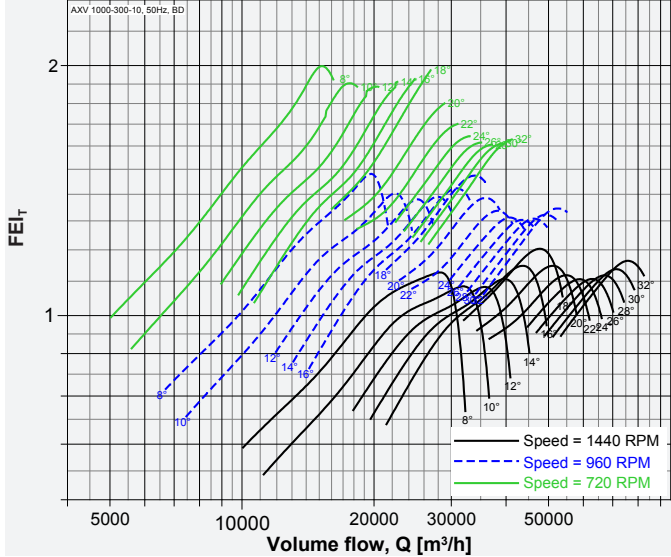

Model: AXV 1120-300-5

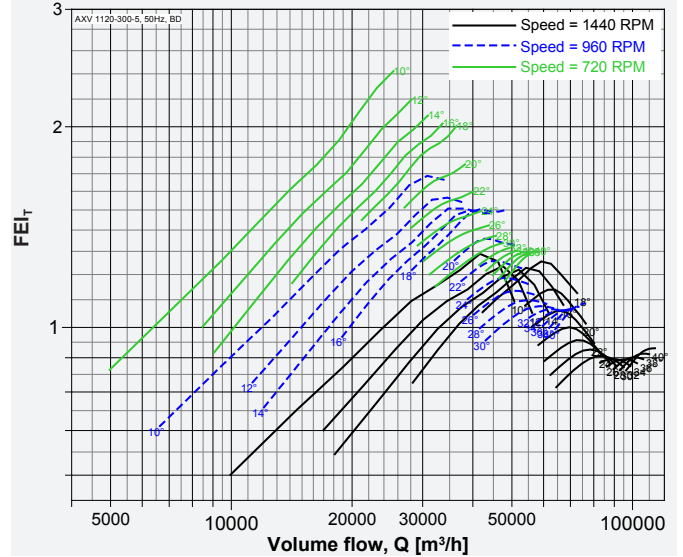

Model: AXV 1250-370-6

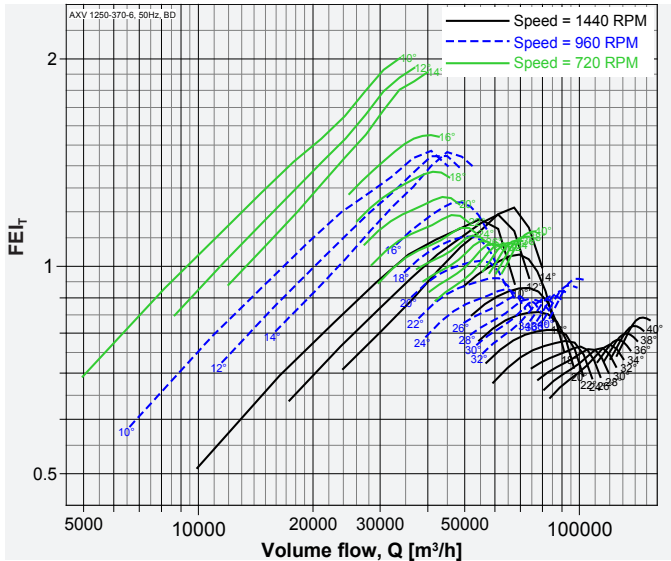

Model: AXV 1400-420-6

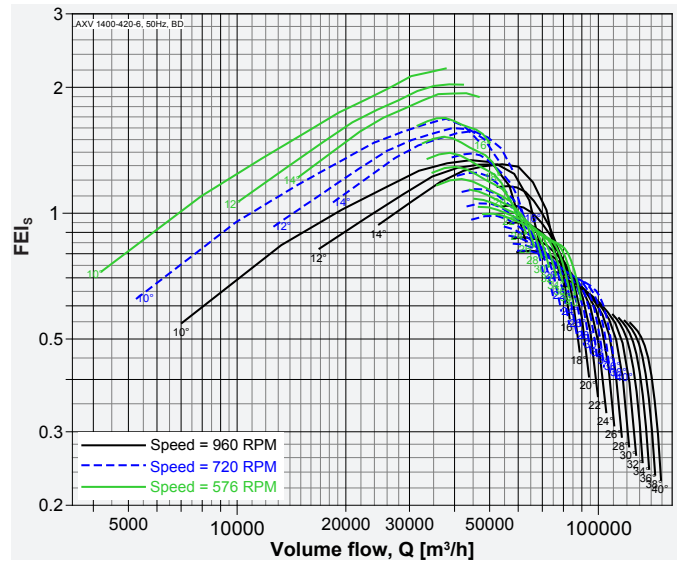

Performance of size 250 to 1250 certified is for installation type D - Ducted inlet, Ducted outlet, Performance of size 1400 to 2800 certified is for installation type A - Free inlet, Free outlet. Power rating (kW) does not include transmission losses. Performance ratings do not include the effects of appurtenances (accessories-belt cover, pulley & belt). FEI<sub>t</sub> / FEI<sub>s</sub> values are calculated in accordance with ANSI/AMCA Standard 208 and are based on default motor efficiencies (Belt Driven type). FEI<sub>t</sub> / FEI<sub>s</sub> values for fans with specific motors will vary slightly from those shown.





Model: AXV 1600-420-6

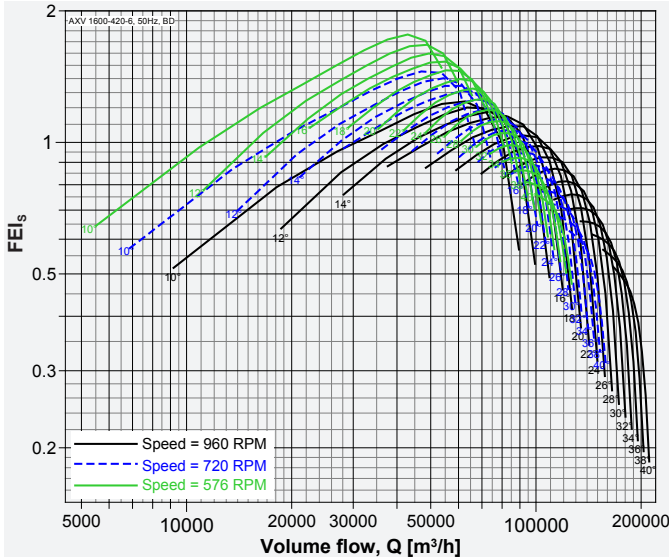

Model: AXV 1800-540-6

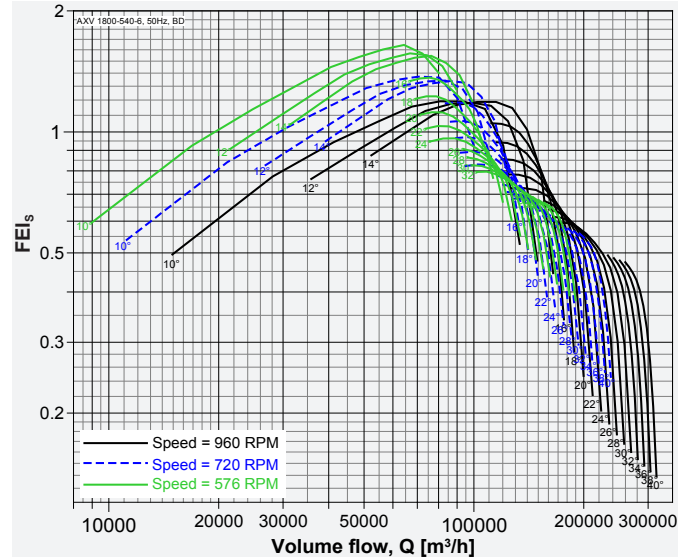

Model: AXV 2000-600-6

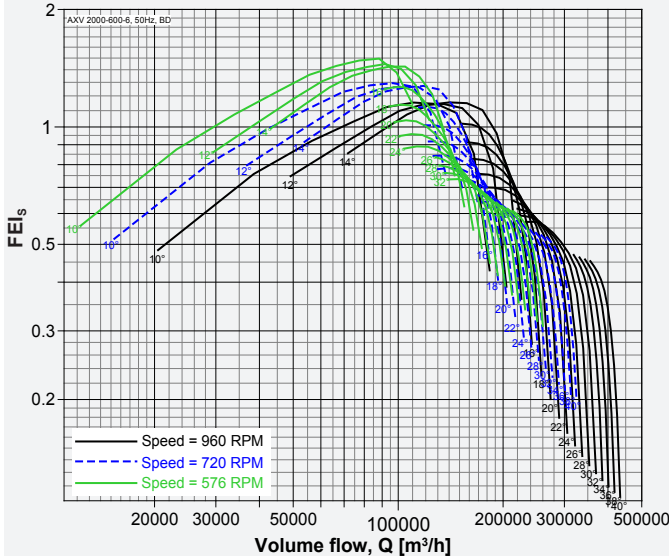

Model: AXV 2200-660-6

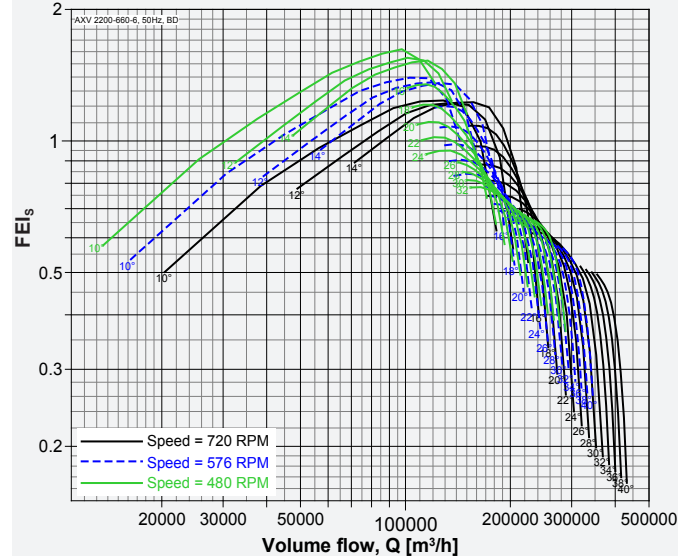

Model: AXV 2400-720-6

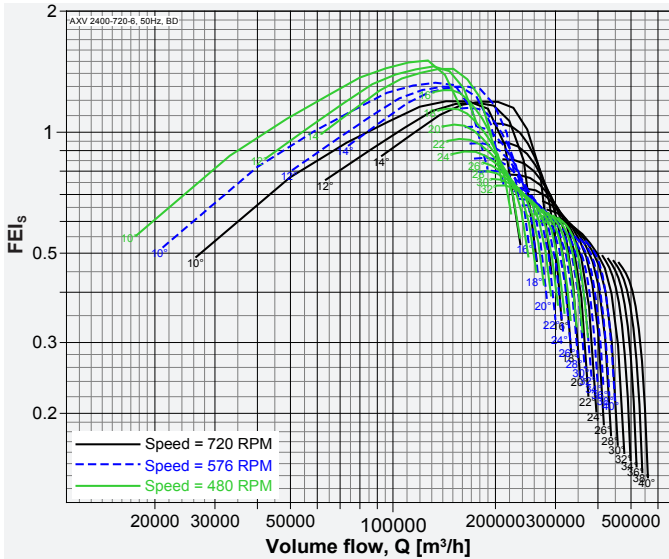

Model: AXV 2500-750-6

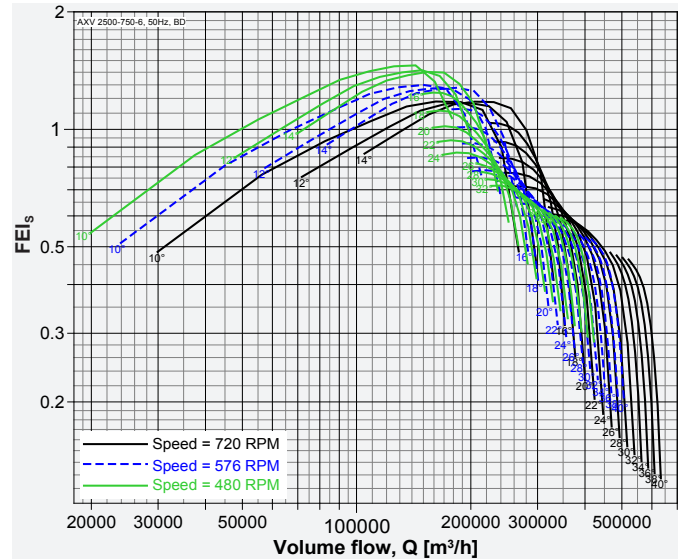

Performance of size 250 to 1250 certified is for installation type D - Ducted inlet, Ducted outlet, Performance of size 1400 to 2800 certified is for installation type A - Free inlet, Free outlet. Power rating (kW) does not include transmission losses. Performance ratings do not include the effects of appurtenances (accessories-belt cover, pulley & belt). FEI<sub>r</sub> / FEI<sub>s</sub> values are calculated in accordance with ANSI/AMCA Standard 208 and are based on default motor efficiencies (Belt Driven type). FEI<sub>r</sub> / FEI<sub>s</sub> values for fans with specific motors will vary slightly from those shown.



Model: AXV 2600-780-6

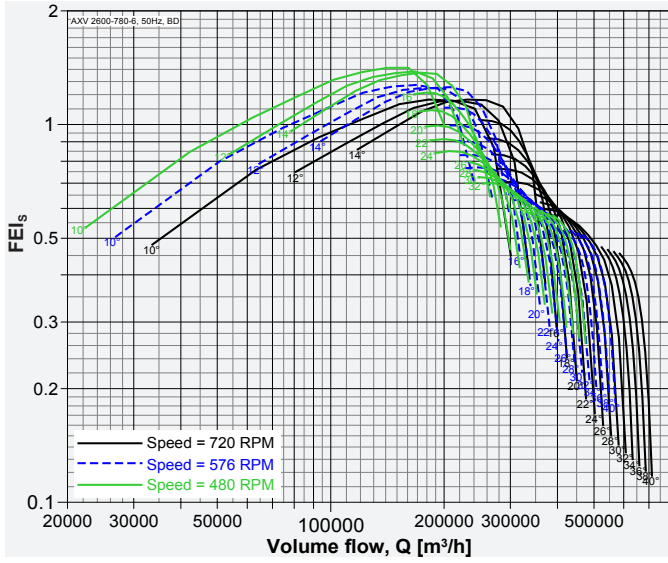

Model: AXV 2800-840-6

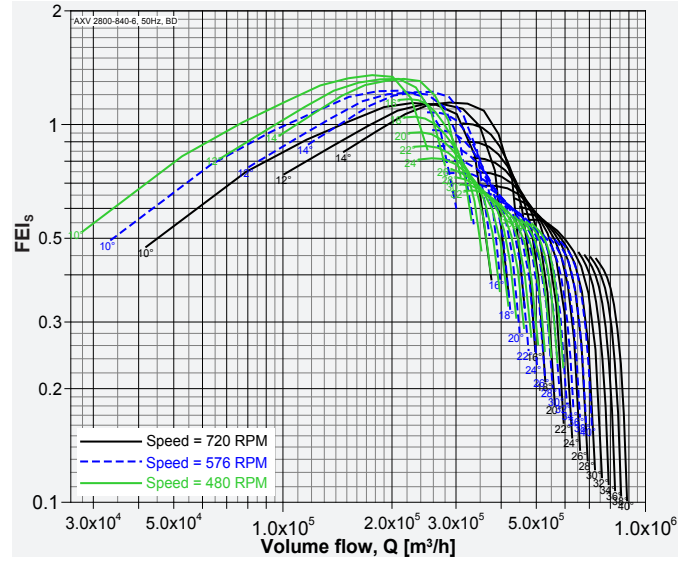

Performance of size 250 to 1250 certified is for installation type D - Ducted inlet, Ducted outlet, Performance of size 1400 to 2800 certified is for installation type A - Free inlet, Free outlet. Power rating (kW) does not include transmission losses. Performance ratings do not include the effects of appurtenances (accessories-belt cover, pulley & belt). FEI<sub>1</sub> / FEI<sub>s</sub> values are calculated in accordance with ANSI/AMCA Standard 208 and are based on default motor efficiencies (Belt Driven type). FEI<sub>1</sub> / FEI<sub>s</sub> values for fans with specific motors will vary slightly from those shown.

# AMCA - FEG rating

## Fan Efficiency Grade - AXV



Certified FEGs are determined in accordance with AMCA 205 Energy Efficiency Classification for fans. In conjunction with AMCA 211 Certified Ratings Program, Product Rating Manual for Fan Air Performance. This classification is based on total peak, or optimum, fan efficiency for a given fan speed, impeller diameter and test application category (test configuration). For the purpose of energy classification, the peak efficiency shall be determined at a speed that is lower than the fan's maximum design speed.

The AMCA Certified Ratings Seal applies to the Fan Efficiency Grade (FEG) for AXV series Axial Fan model AXV 250 to AXV 2800 as shown in the table below.

Fan Model No.	Fan Speed (rpm)	Fan Efficiency Grades	Fan Model No.	Fan Speed (rpm)	Fan Efficiency Grade
AXV 250-110-3	3600/1800/1200	FEG 67	AXV 630-150-5	1800/1200/900	FEG 75
AXV 250-110-6	3600/1800/1200	FEG 60	AXV 630-150-10	1800/1200/900	FEG 75
AXV 280-110-3	3600/1800/1200	FEG 75	AXV 630-200-9	3456/1728/1152	FEG 63
AXV 280-110-6	3600/1800/1200	FEG 67	AXV 630-250-7	1800/1200/900	FEG 71
AXV 315-110-3	3600/1800/1200	FEG 71	AXV 630-250-14	1800/1200/900	FEG 63
AXV 315-110-6	3600/1800/1200	FEG 67	AXV 710-110-3	1800/1200/900	FEG 75
AXV 355-110-3	3600/1800/1200	FEG 75	AXV 710-110-6	1800/1200/900	FEG 75
AXV 355-110-6	3600/1800/1200	FEG 71	AXV 710-150-5	1800/1200/900	FEG 75
AXV 355-150-7	3456/1728/1152	FEG 63	AXV 710-150-10	1800/1200/900	FEG 75
AXV 400-110-3	3600/1800/1200	FEG 75	AXV 710-250-7	1800/1200/900	FEG 71
AXV 400-110-6	3600/1800/1200	FEG 71	AXV 710-250-9	1728/1152/864	FEG 67
AXV 400-150-5	3600/1800/1200	FEG 71	AXV 710-250-14	1800/1200/900	FEG 67
AXV 400-150-7	3456/1728/1152	FEG 67	AXV 800-150-5	1200/900/720	FEG 75
AXV 400-150-10	3600/1800/1200	FEG 63	AXV 800-150-10	1200/900/720	FEG 75
AXV 450-110-3	3600/1800/1200	FEG 71	AXV 800-250-7	1800/1200/900	FEG 75
AXV 450-110-6	3600/1800/1200	FEG 80	AXV 800-250-9	1728/1152/864	FEG 71
AXV 450-150-5	3600/1800/1200	FEG 71	AXV 800-250-14	1800/1200/900	FEG 71
AXV 450-150-7	3456/1728/1152	FEG 63	AXV 900-250-7	1200/900/720	FEG 71
AXV 450-150-10	3600/1800/1200	FEG 63	AXV 900-250-14	1200/900/720	FEG 67
AXV 500-110-3	3600/1800/1200	FEG 75	AXV 900-300-10	1728/1152/864	FEG 63
AXV 500-110-6	3600/1800/1200	FEG 75	AXV 1000-250-7	1200/900/720	FEG 71
AXV 500-150-5	3600/1800/1200	FEG 71	AXV 1000-250-14	1200/900/720	FEG 67
AXV 500-150-7	3456/1728/1152	FEG 71	AXV 1000-300-10	1728/1152/864	FEG 71
AXV 500-150-10	3600/1800/1200	FEG 71	AXV 1120-300-5	1728/1152/864	FEG 71
AXV 500-250-7	3600/1800/1200	FEG 56	AXV 1250-370-6	1728/1152/864	FEG 71
AXV 560-110-3	1800/1200/900	FEG 71	AXV 1400-420-6	1152/864/691	FEG 75
AXV 560-110-6	1800/1200/900	FEG 75	AXV 1600-420-6	1152/864/691	FEG 67
AXV 560-150-5	1800/1200/900	FEG 75	AXV 1800-540-6	1152/864/691	FEG 75
AXV 560-150-10	1800/1200/900	FEG 71	AXV 2000-600-6	1152/864/691	FEG 75
AXV 560-200-9	3456/1728/1152	FEG 67	AXV 2200-660-6	864/691/576	FEG 75
AXV 560-250-7	1800/1200/900	FEG 67	AXV 2400-720-6	864/691/576	FEG 75
AXV 560-250-14	1800/1200/900	FEG 56	AXV 2500-750-6	864/691/576	FEG 75
AXV 630-110-3	1800/1200/900	FEG 75	AXV 2600-780-6	864/691/576	FEG 75
AXV 630-110-6	1800/1200/900	FEG 75	AXV 2800-840-6	864/691/576	FEG 75



# Performance Curve

AXV 250-110-3, 60 Hz

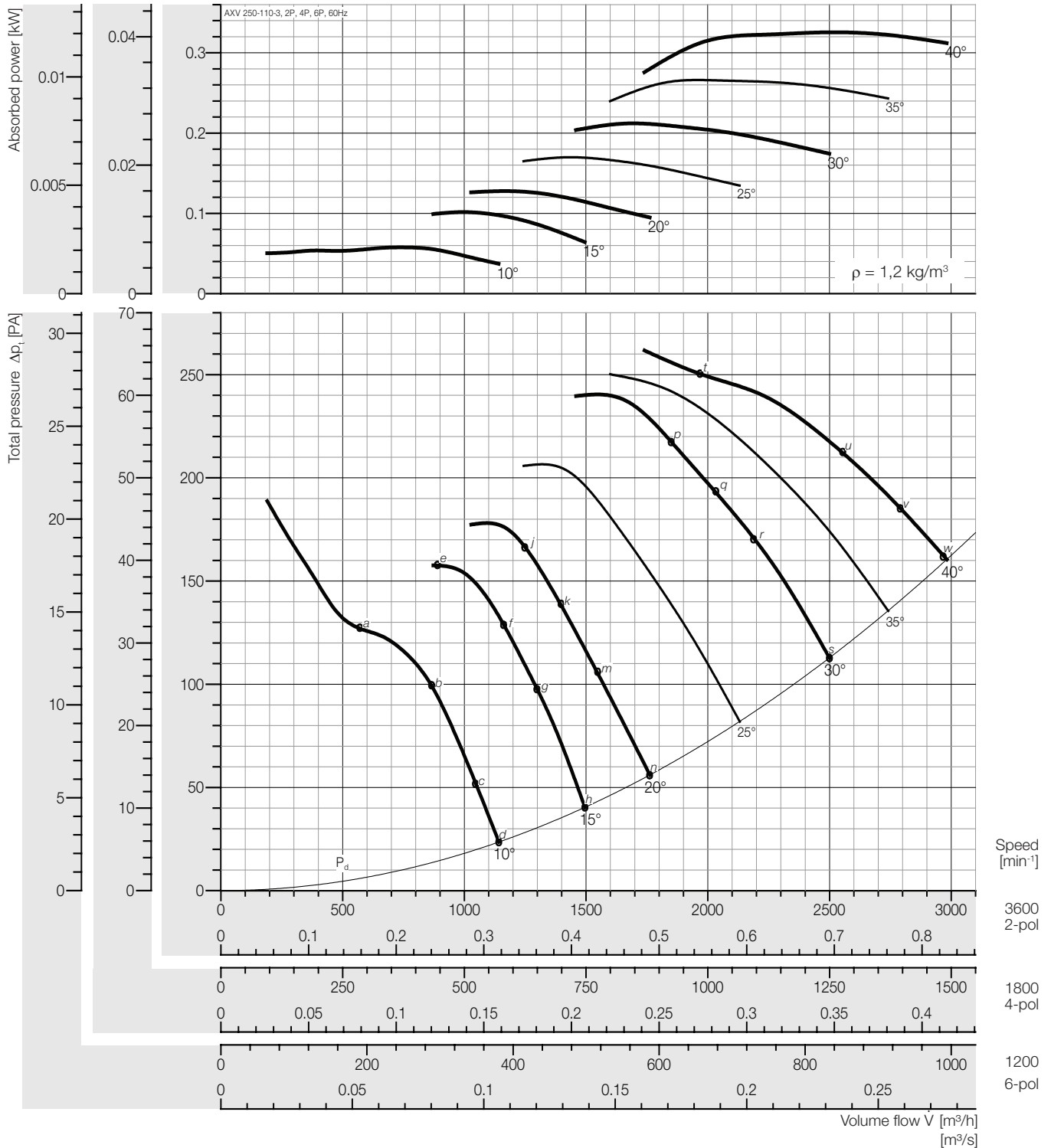

### Peak absorbed power [kW]

n [min <sup>-1</sup> ]	Pitch angle [°]						
	10	15	20	25	30	35	40
1200	0,002	0,004	0,005	0,006	0,008	0,010	0,012
Motor	0,06						
1800	0,007	0,013	0,016	0,021	0,027	0,033	0,041
Motor	0,09						
3600	0,057	0,102	0,128	0,170	0,212	0,266	0,325
Motor	0,12		0,18		0,25	0,37	

### Sound power level, Lwi(A) [dB(A)]

Lwi(A)	a	b	c	d	e	f	g	h	j	k	m	n	p	q	r	s	t	u	v	w
2P	91	86	88	90	93	89	90	93	87	88	89	91	90	91	92	93	96	97	99	94
4P	71	67	68	70	74	69	69	72	66	67	68	70	69	71	71	73	76	77	78	74
6P	60	55	56	57	62	56	57	59	54	55	55	57	57	59	59	60	65	65	65	62

Plastic Duct

Lwi(A)	a	b	c	d	e	f	g	h	j	k	m	n	p	q	r	s	t	u	v	w
2P	89	84	86	88	91	87	88	91	85	86	87	89	88	89	90	91	94	95	97	92
4P	69	65	66	68	72	67	67	70	64	65	66	68	67	69	69	71	74	75	76	72
6P	58	53	54	55	60	54	55	57	52	53	53	55	55	57	57	58	63	63	63	60

\* Unlined Metal Duct

Fan test laboratory AMCA 210 Test Chamber. Performance certified is for installation type D - Ducted inlet, Ducted outlet. Performance ratings do not include the effects of appurtenances (accessories-belt cover, pulley & belt).

Dimensions + Accessories Page 191 - 194;  
Sound power frequency spectrum L<sub>w</sub>(f) Page 196 - 200.

The A-weighted sound ratings shown have been calculated per AMCA International Standard 301. Values shown are for inlet Lwi(A) sound power levels for installation Type D: ducted inlet, ducted outlet. Ratings include the effects of duct end correction.

\* Sound power level with unlined metal duct were obtained from the test in the reverberant room. Data are not licensed by AMCA.



# Performance Curve

AXV 250-110-6, 60 Hz

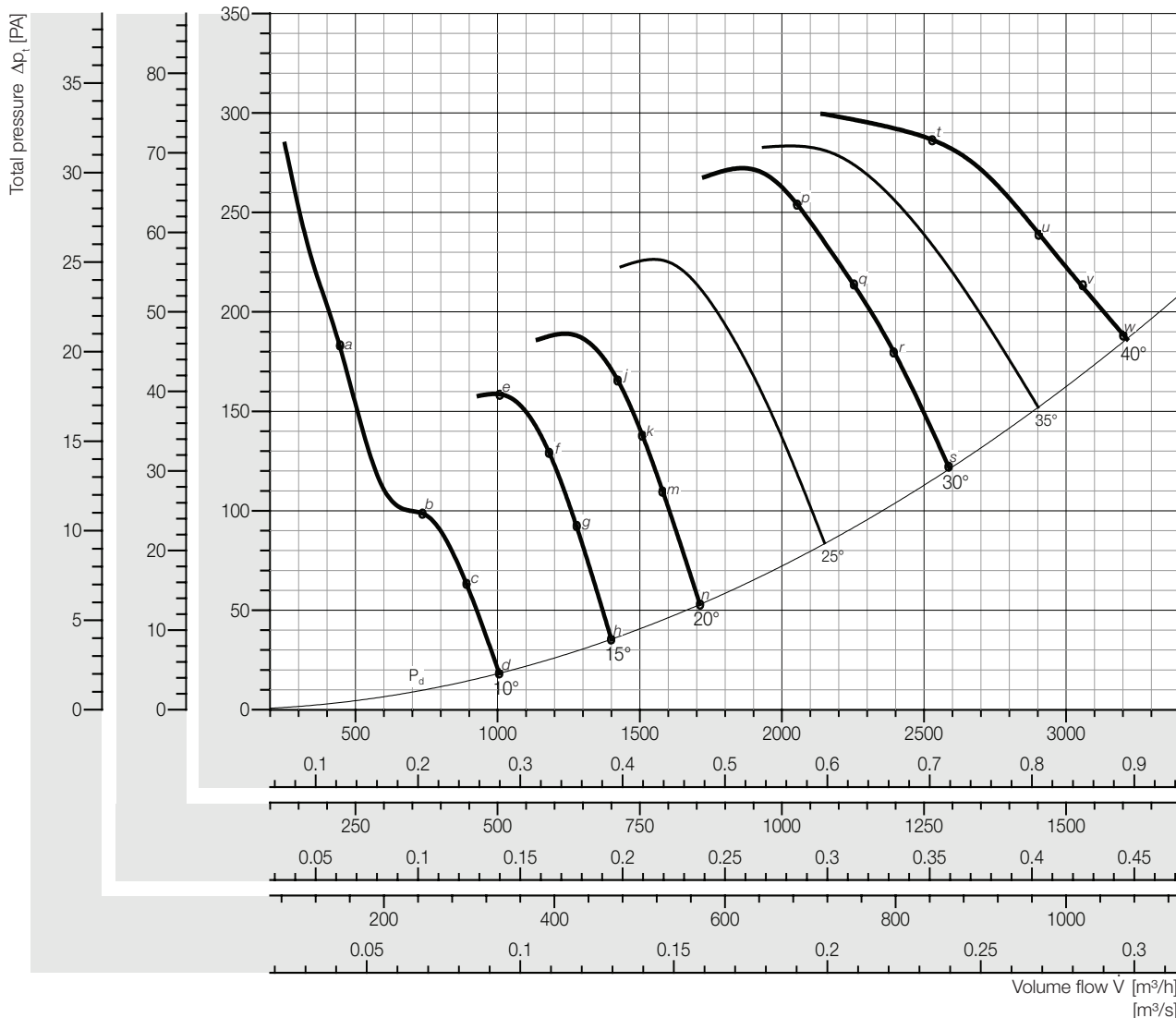

### Peak absorbed power [kW]

n [min <sup>-1</sup> ]	Pitch angle [°]						
	10	15	20	25	30	35	40
1200	0,004	0,004	0,006	0,008	0,011	0,014	0,017
Motor	0,06						
1800	0,015	0,015	0,019	0,029	0,038	0,048	0,058
Motor	0,09						
3600	0,120	0,119	0,153	0,229	0,306	0,383	0,465
Motor	0,12		0,18	0,25	0,37	0,55	

### Sound power level, Lwi(A) [dB(A)]

Lwi(A)	a	b	c	d	e	f	g	h	j	k	m	n	p	q	r	s	t	u	v	w
2P	92	89	86	86	94	90	90	91	91	91	92	92	89	91	91	92	94	95	97	97
4P	71	71	67	67	74	70	71	72	71	72	72	73	70	72	71	72	75	76	77	77
6P	60	59	56	56	63	59	59	60	60	60	60	61	59	60	60	61	64	64	66	66

*Plastic Duct*

Lwi(A)	a	b	c	d	e	f	g	h	j	k	m	n	p	q	r	s	t	u	v	w
2P	90	87	84	84	92	88	88	89	89	89	90	90	87	89	89	90	92	93	95	95
4P	69	69	65	65	72	68	69	70	69	70	70	71	68	70	69	70	73	74	75	75
6P	58	57	54	54	61	57	57	58	58	58	58	59	57	58	58	59	62	62	64	64

*\* Unlined Metal Duct*

Fan test laboratory AMCA 210 Test Chamber. Performance certified is for installation type D - Ducted inlet, Ducted outlet. Performance ratings do not include the effects of appurtenances (accessories-belt cover, pulley & belt).

Dimensions + Accessories Page 191 ~ 194;  
Sound power frequency spectrum L<sub>w</sub>(A) Page 196 ~ 200.

The A-weighted sound ratings shown have been calculated per AMCA International Standard 301. Values shown are for inlet Lwi(A) sound power levels for installation Type D: ducted inlet, ducted outlet. Ratings include the effects of duct end correction.

\* Sound power level with unlined metal duct were obtained from the test in the reverberant room. Data are not licensed by AMCA.



# Performance Curve

AXV 280-110-3, 60 Hz

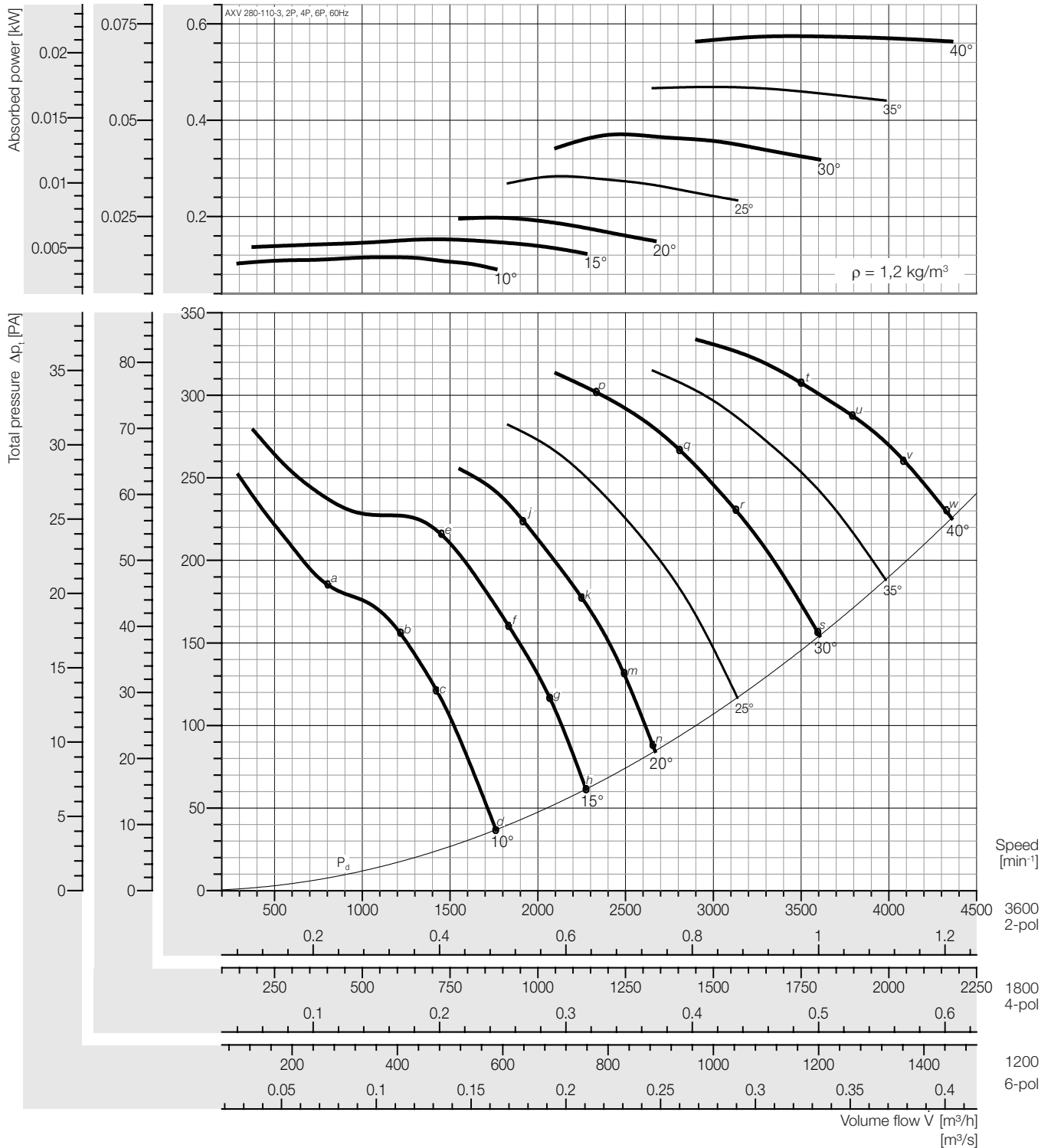

### Peak absorbed power [kW]

n [min <sup>-1</sup> ]	Pitch angle [°]						
	10	15	20	25	30	35	40
1200	0,004	0,006	0,007	0,011	0,014	0,017	0,021
Motor	0,06						
1800	0,014	0,019	0,025	0,035	0,046	0,059	0,072
Motor	0,09						
3600	0,116	0,153	0,197	0,284	0,370	0,469	0,574
Motor	0,12	0,18	0,25	0,37	0,55		0,75

### Sound power level, Lwi(A) [dB(A)]

Lwi(A)	a	b	c	d	e	f	g	h	j	k	m	n	p	q	r	s	t	u	v	w
2P	91	90	90	91	89	90	91	92	89	91	92	93	90	92	92	94	93	94	95	96
4P	71	71	69	70	68	68	69	71	68	69	70	71	70	72	72	74	73	74	74	76
6P	60	60	58	59	56	57	57	59	57	58	58	59	58	60	61	62	62	62	63	64

Plastic Duct

Lwi(A)	a	b	c	d	e	f	g	h	j	k	m	n	p	q	r	s	t	u	v	w
2P	89	88	88	89	87	88	89	90	87	89	90	91	88	90	90	92	91	92	93	94
4P	69	69	67	68	66	66	67	69	68	67	68	69	68	70	70	72	71	72	72	74
6P	58	58	56	57	54	55	55	57	55	56	56	57	56	58	59	60	60	60	61	62

\* Unlined Metal Duct

Fan test laboratory AMCA 210 Test Chamber. Performance certified is for installation type D - Ducted inlet, Ducted outlet. Performance ratings do not include the effects of appearances (accessories-belt cover, pulley & belt).

Dimensions + Accessories Page 191 - 194;  
Sound power frequency spectrum L<sub>w</sub> Page 196 - 200.

The A-weighted sound ratings shown have been calculated per AMCA International Standard 301. Values shown are for inlet Lwi(A) sound power levels for installation Type D: ducted inlet, ducted outlet. Ratings include the effects of duct end correction.

\* Sound power level with unlined metal duct were obtained from the test in the reverberant room. Data are not licensed by AMCA.



# Performance Curve

AXV 280-110-6, 2P, 4P, 6P, 60 Hz

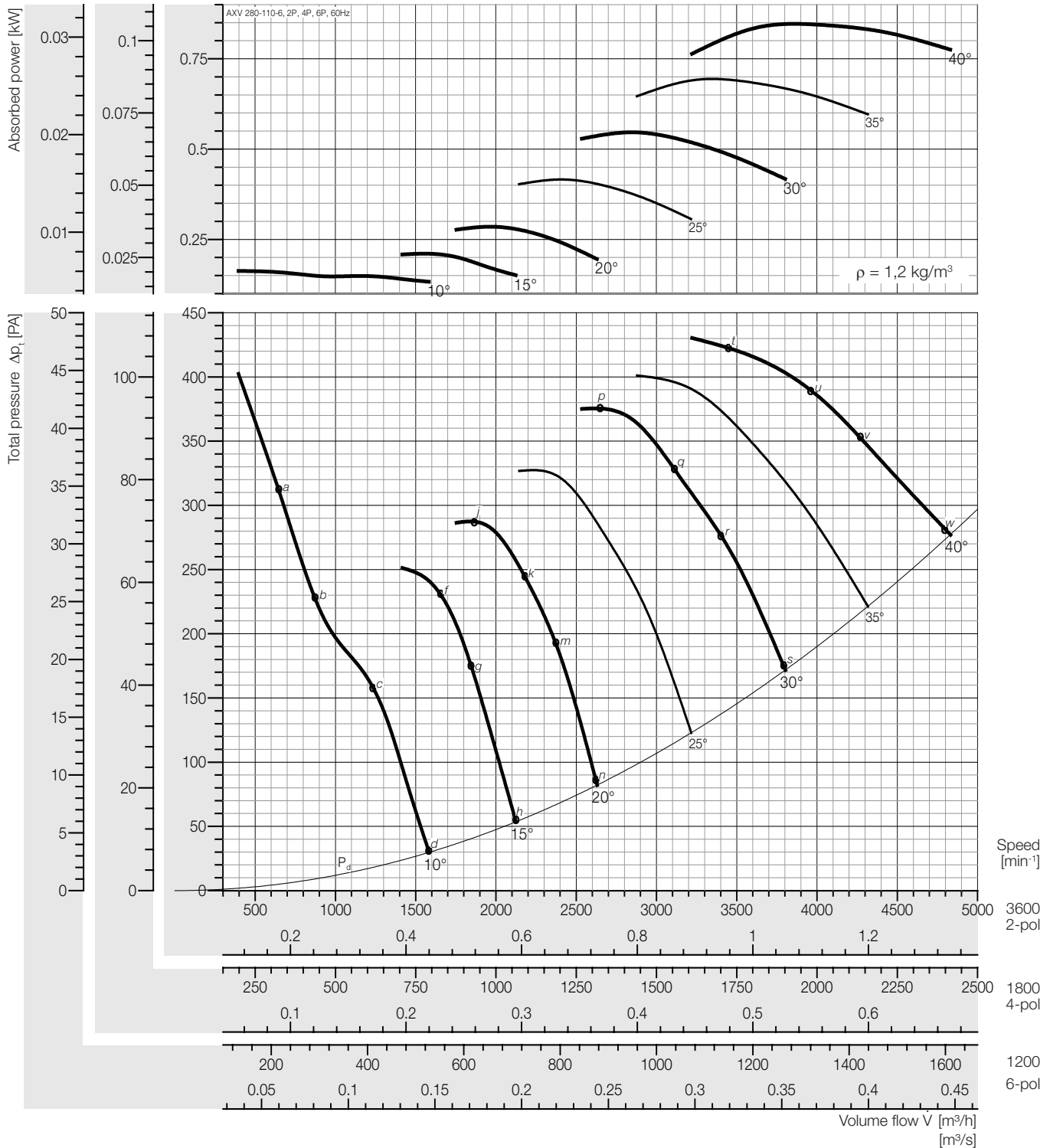

### Peak absorbed power [kW]

n [min <sup>-1</sup> ]	Pitch angle [°]						
	10	15	20	25	30	35	40
1200	0,006	0,008	0,011	0,015	0,020	0,026	0,031
Motor	0,06						
1800	0,020	0,026	0,036	0,052	0,068	0,087	0,106
Motor	0,09						
3600	0,164	0,211	0,285	0,416	0,546	0,694	0,846
Motor	0,18	0,25	0,37	0,55	0,75		1,1

### Sound power level, Lwi(A) [dB(A)]

Lwi(A)	a	b	c	d	e	f	g	h	j	k	m	n	p	q	r	s	t	u	v	w
2P	94	93	90	91	-	93	94	95	92	93	94	94	96	93	95	96	96	96	96	98
4P	73	73	71	72	-	73	73	75	73	72	73	74	80	73	75	76	75	75	75	76
6P	62	62	61	61	-	62	62	64	62	62	62	63	70	62	63	64	65	64	64	65

Plastic Duct

Lwi(A)	a	b	c	d	e	f	g	h	j	k	m	n	p	q	r	s	t	u	v	w
2P	92	91	88	89	-	91	92	93	90	91	92	92	94	91	93	94	94	94	94	96
4P	71	71	69	70	-	71	71	73	71	70	71	72	78	71	73	74	73	73	73	74
6P	60	60	59	59	-	60	60	62	60	60	60	61	68	60	61	62	63	62	62	63

\* Unlined Metal Duct

Fan test laboratory AMCA 210 Test Chamber. Performance certified is for installation type D - Ducted inlet, Ducted outlet. Performance ratings do not include the effects of appurtenances (accessories-belt cover, pulley & belt).

Dimensions + Accessories Page 191 - 194;  
Sound power frequency spectrum L<sub>w</sub>(A) Page 196 - 200.

The A-weighted sound ratings shown have been calculated per AMCA International Standard 301. Values shown are for inlet LwiA sound power levels for installation Type D: ducted inlet, ducted outlet. Ratings include the effects of duct end correction.

\* Sound power level with unlined metal duct were obtained from the test in the reverberant room. Data are not licensed by AMCA.



# Performance Curve

AXV 315-110-3, 60 Hz

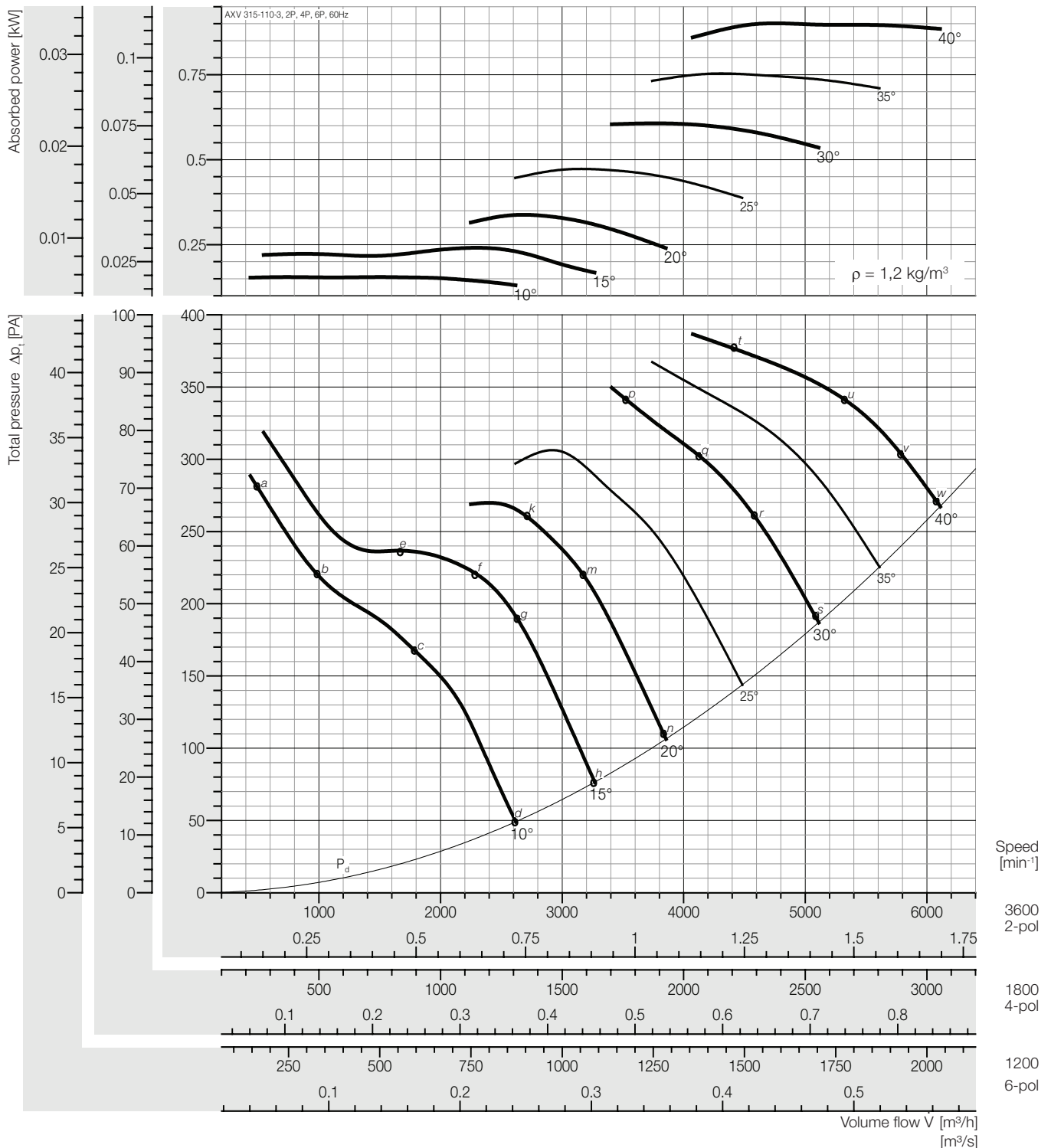

### Peak absorbed power [kW]

n [min <sup>-1</sup> ]	Pitch angle [°]						
	10	15	20	25	30	35	40
1200	0,006	0,009	0,012	0,017	0,022	0,028	0,033
Motor	0,06						
1800	0,019	0,030	0,042	0,059	0,076	0,094	0,113
Motor	0,09						0,12
3600	0,155	0,241	0,337	0,472	0,607	0,753	0,901
Motor	0,18	0,25	0,37	0,55	0,75	1,1	

### Sound power level, Lwi(A) [dB(A)]

Lwi(A)	a	b	c	d	e	f	g	h	j	k	m	n	p	q	r	s	t	u	v	w
2P	91	92	91	90	95	90	88	92	-	89	89	94	92	93	95	97	95	96	96	96
4P	72	72	74	71	76	72	70	72	-	70	70	74	73	74	75	76	76	76	77	77
6P	60	60	63	59	64	61	59	60	-	59	59	63	62	62	63	64	65	65	66	66

Plastic Duct

Lwi(A)	a	b	c	d	e	f	g	h	j	k	m	n	p	q	r	s	t	u	v	w
2P	89	90	89	88	93	88	86	90	-	87	87	92	90	91	93	95	93	94	94	94
4P	70	70	72	69	74	70	68	70	-	68	68	72	71	72	73	74	74	74	75	75
6P	58	58	61	57	62	59	57	58	-	57	57	61	60	60	61	62	63	63	64	64

\* Unlined Metal Duct

Fan test laboratory AMCA 210 Test Chamber. Performance certified is for installation type D - Ducted inlet, Ducted outlet. Performance ratings do not include the effects of appurtenances (accessories-belt cover, pulley & belt).

Dimensions + Accessories Page 191 - 194;  
Sound power frequency spectrum L<sub>w</sub> Page 196 - 200.

The A-weighted sound ratings shown have been calculated per AMCA International Standard 301. Values shown are for inlet Lwi(A) sound power levels for installation Type D: ducted inlet, ducted outlet. Ratings include the effects of duct end correction.

\* Sound power level with unlined metal duct were obtained from the test in the reverberant room. Data are not licensed by AMCA.





# Performance Curve

AXV 315-110-6, 60 Hz

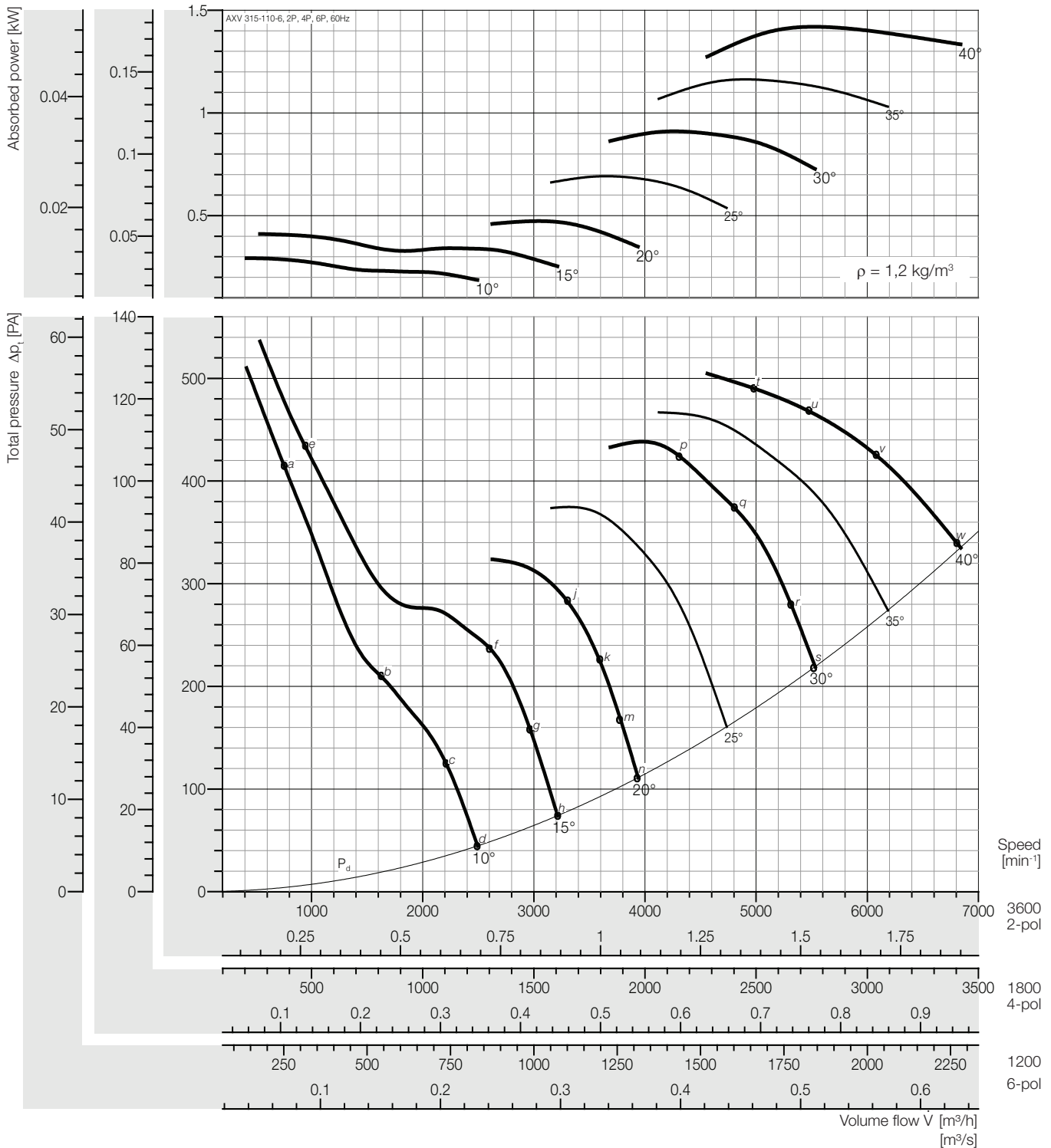

### Peak absorbed power [kW]

n [min <sup>-1</sup> ]	Pitch angle [°]						
	10	15	20	25	30	35	40
1200	0,006	0,008	0,011	0,015	0,020	0,026	0,031
Motor	0,06						
1800	0,020	0,026	0,036	0,052	0,068	0,087	0,106
Motor	0,09						
3600	0,164	0,211	0,285	0,416	0,546	0,694	0,846
Motor	0,18	0,25	0,37	0,55	0,75	1,1	

### Sound power level, Lwi(A) [dB(A)]

Lwi(A)	a	b	c	d	e	f	g	h	j	k	m	n	p	q	r	s	t	u	v	w
2P	94	93	90	91	98	93	94	95	92	93	94	94	96	93	95	96	96	96	96	98
4P	73	73	71	72	77	73	73	75	73	72	73	74	80	73	75	76	75	75	75	76
6P	62	62	61	61	66	62	62	64	62	62	62	63	70	62	63	64	65	64	64	65

Plastic Duct

Lwi(A)	a	b	c	d	e	f	g	h	j	k	m	n	p	q	r	s	t	u	v	w
2P	92	91	88	89	96	91	92	93	90	91	92	92	94	91	93	94	94	94	94	96
4P	71	71	69	70	75	71	71	73	71	70	71	72	78	71	73	74	73	73	73	74
6P	60	60	59	59	64	60	60	62	60	60	60	61	68	60	61	62	63	62	62	63

\* Unlined Metal Duct

Fan test laboratory AMCA 210 Test Chamber. Performance certified is for installation type D - Ducted inlet, Ducted outlet. Performance ratings do not include the effects of appurtenances (accessories-belt cover, pulley & belt).

Dimensions + Accessories Page 191 ~ 194;  
Sound power frequency spectrum L<sub>w(f)</sub> Page 196 ~ 200.

The A-weighted sound ratings shown have been calculated per AMCA International Standard 301. Values shown are for inlet LwiA sound power levels for installation Type D: ducted inlet, ducted outlet. Ratings include the effects of duct end correction.

\* Sound power level with unlined metal duct were obtained from the test in the reverberant room. Data are not licensed by AMCA.



# Performance Curve

AXV 355-110-3, 60 Hz

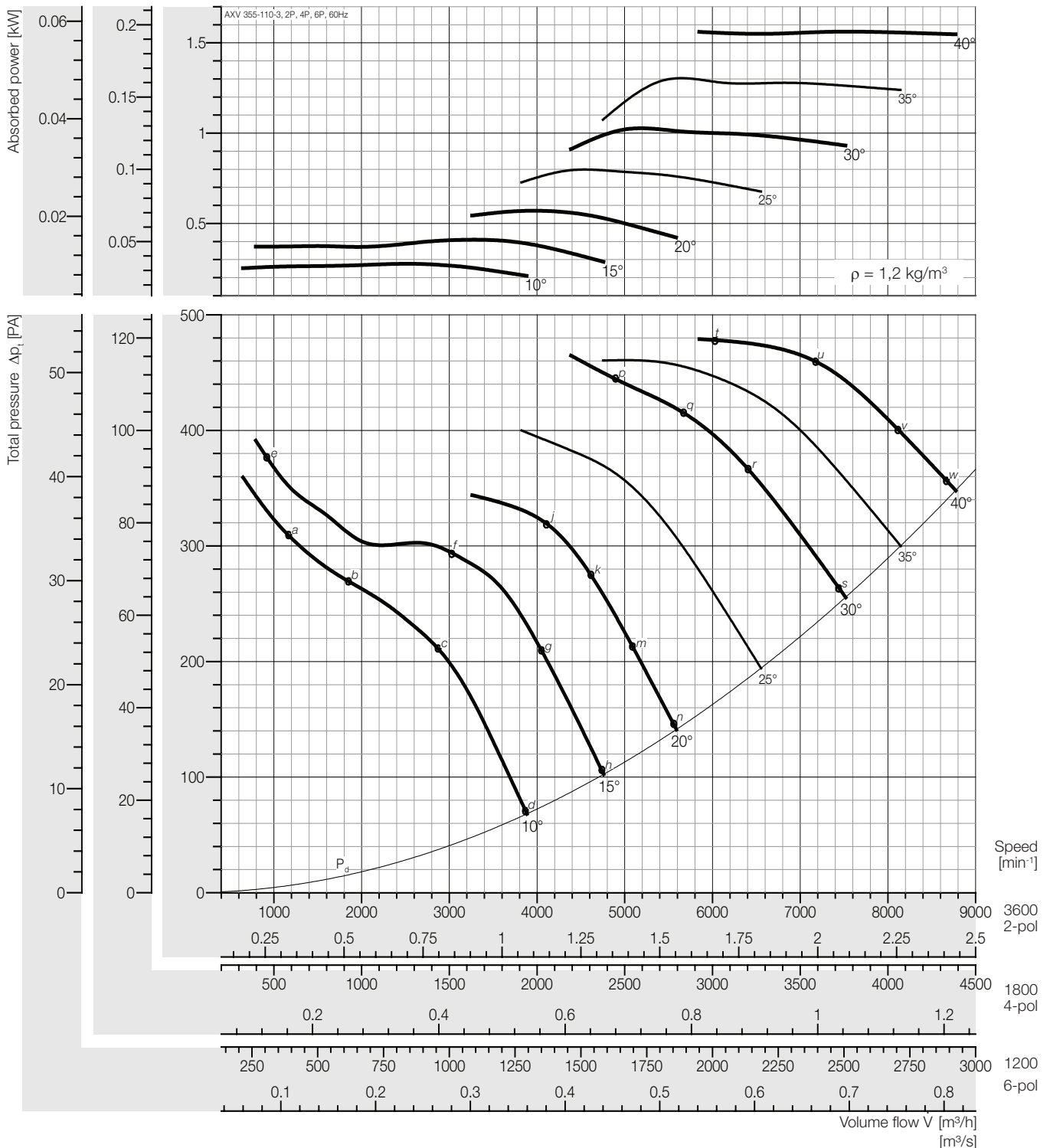

### Peak absorbed power [kW]

n [min <sup>-1</sup> ]	Pitch angle [°]						
	10	15	20	25	30	35	40
1200	0,010	0,015	0,021	0,030	0,038	0,048	0,058
Motor	0,09						
1800	0,035	0,051	0,071	0,100	0,128	0,162	0,195
Motor	0,09						
3600	0,277	0,409	0,570	0,797	1,025	1,299	1,562
Motor	0,37	0,55	0,75	1,1	1,5	2,2	

### Sound power level, Lwi(A) [dB(A)]

Lwi(A)	Pitch angle [°]																			
	a	b	c	d	e	f	g	h	j	k	m	n	p	q	r	s	t	u	v	w
2P	96	97	93	92	96	95	93	94	94	94	97	97	96	97	98	100	96	97	99	99
4P	76	78	75	73	77	77	73	74	74	74	76	77	78	78	79	79	78	78	79	79
6P	65	66	64	62	65	66	62	63	63	63	64	64	67	67	68	67	67	67	67	67
Plastic Duct																				
Lwi(A)	a	b	c	d	e	f	g	h	j	k	m	n	p	q	r	s	t	u	v	w
2P	94	95	91	90	94	93	91	92	92	92	95	95	94	95	96	98	94	95	97	97
4P	74	76	73	71	75	75	71	72	72	72	74	75	76	76	77	77	76	76	77	77
6P	63	64	62	60	63	64	60	61	61	61	62	62	65	65	66	65	65	65	65	65

Fan test laboratory AMCA 210 Test Chamber. Performance certified is for installation type D - Ducted inlet, Ducted outlet. Performance ratings do not include the effects of appurtenances (accessories-belt cover, pulley & belt).

Dimensions + Accessories Page 191 - 194;  
Sound power frequency spectrum L<sub>w</sub> Page 196 - 200.

The A-weighted sound ratings shown have been calculated per AMCA International Standard 301. Values shown are for inlet LwiA sound power levels for installation Type D: ducted inlet, ducted outlet. Ratings include the effects of duct end correction.

\* Sound power level with unlined metal duct were obtained from the test in the reverberant room. Data are not licensed by AMCA.



# Performance Curve

AXV 355-110-6, 60 Hz

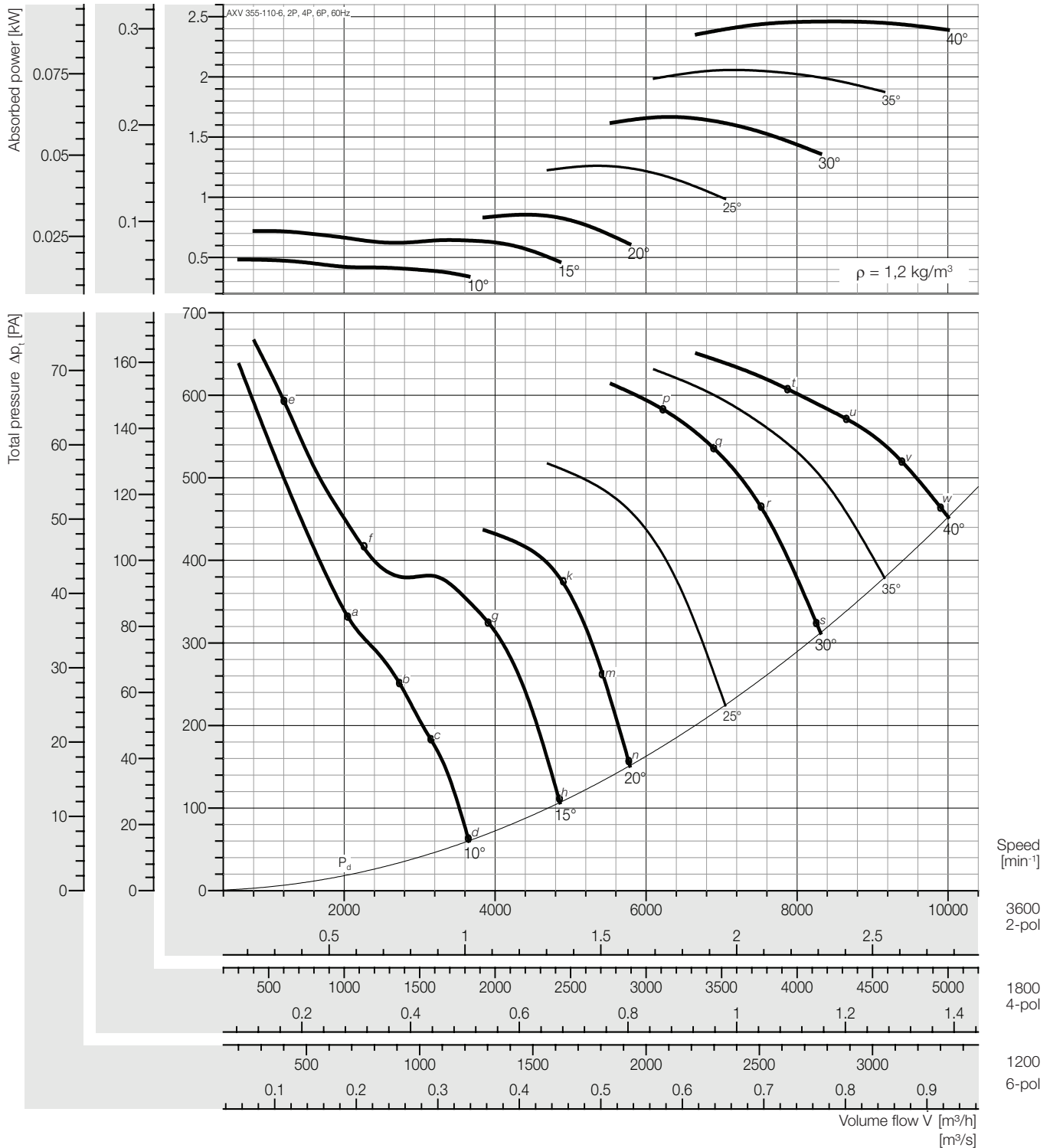

### Peak absorbed power [kW]

n [min <sup>-1</sup> ]	Pitch angle [°]						
	10	15	20	25	30	35	40
1200	0,018	0,027	0,032	0,047	0,062	0,076	0,091
Motor	0,09						
1800	0,060	0,090	0,107	0,157	0,208	0,257	0,307
Motor	0,09		0,12	0,18	0,25	0,37	
3600	0,483	0,721	0,855	1,260	1,665	2,057	2,460
Motor	0,55	0,75	1,1	1,5	2,2		3,0

### Sound power level, Lwi(A) [dB(A)]

Lwi(A)	a	b	c	d	e	f	g	h	j	k	m	n	p	q	r	s	t	u	v	w
2P	99	99	97	97	103	106	101	99	105	99	100	101	97	98	100	99	99	100	101	102
4P	80	81	78	78	83	85	82	80	83	79	80	81	78	78	79	80	80	81	82	83
6P	69	70	67	67	72	74	71	68	73	68	68	70	67	67	69	69	69	70	71	72

Plastic Duct

Lwi(A)	a	b	c	d	e	f	g	h	j	k	m	n	p	q	r	s	t	u	v	w
2P	97	97	95	95	101	104	99	97	103	97	98	99	95	96	98	97	97	98	99	100
4P	78	79	76	76	81	83	80	78	81	77	78	79	76	76	77	78	78	79	80	81
6P	67	68	65	65	70	72	69	66	71	66	66	68	65	65	67	67	67	68	69	70

\* Unlined Metal Duct

Fan test laboratory AMCA 210 Test Chamber. Performance certified is for installation type D - Ducted inlet, Ducted outlet. Performance ratings do not include the effects of appurtenances (accessories-belt cover, pulley & belt).

Dimensions + Accessories Page 191 - 194;  
Sound power frequency spectrum L<sub>w(f)</sub> Page 196 - 200.

The A-weighted sound ratings shown have been calculated per AMCA International Standard 301. Values shown are for inlet LwiA sound power levels for installation Type D: ducted inlet, ducted outlet. Ratings include the effects of duct end correction.

\* Sound power level with unlined metal duct were obtained from the test in the reverberant room. Data are not licensed by AMCA.



# Performance Curve

AXV 355-150-7, 60 Hz

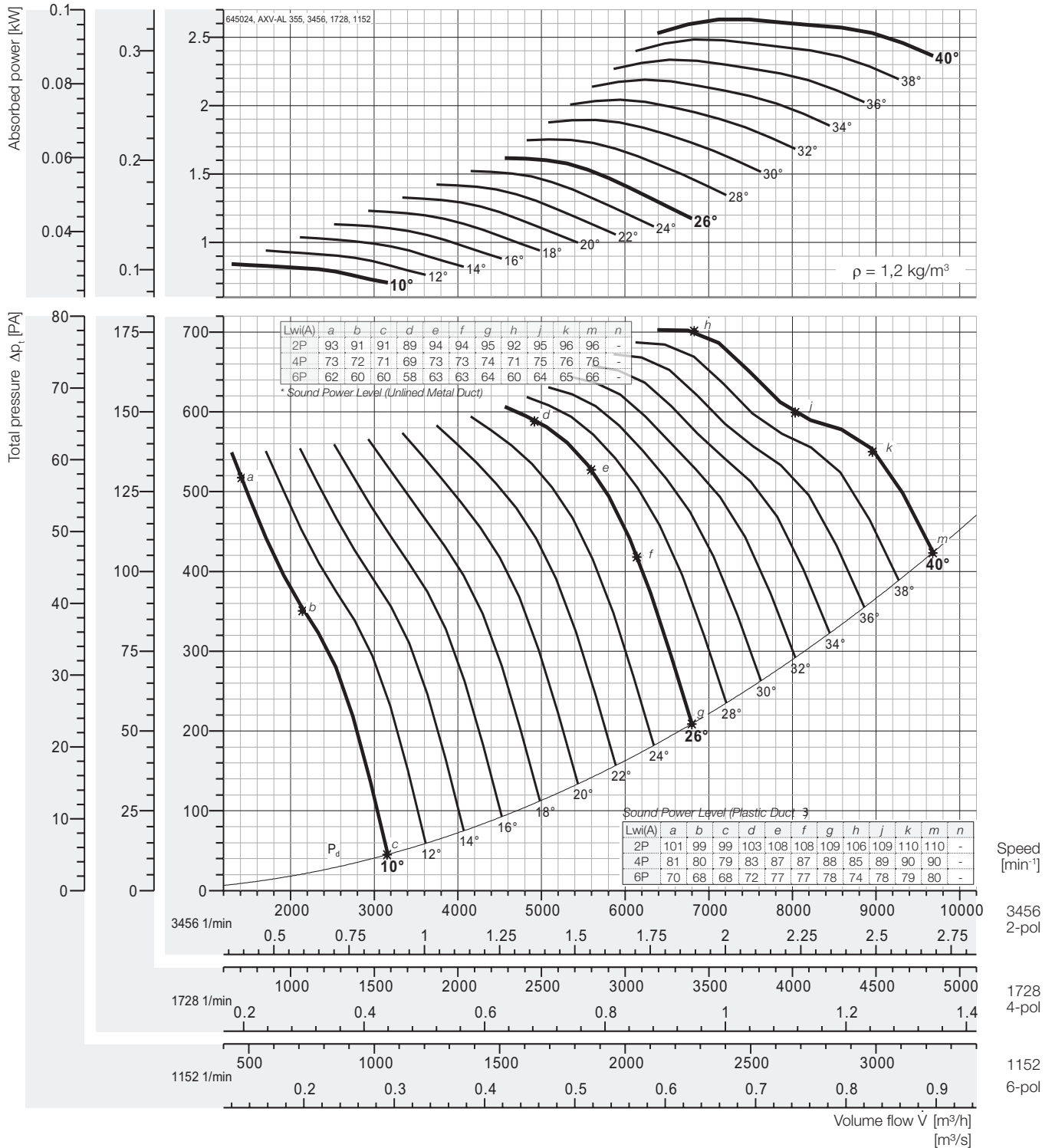

## Peak absorbed power [kW]

\* Out of Range

n [min <sup>-1</sup> ]	Pitch angle [°]																
	8	10	12	14	16	18	20	22	24	26	28	30	32	34	36	38	40
1152 motor	-	0,031	0,035	0,038	0,042	0,046	0,049	0,053	0,056	0,060	0,065	0,070	0,076	0,081	0,087	0,092	0,097
		0,37															
1728 motor	-	0,105	0,118	0,130	0,142	0,154	0,166	0,178	0,190	0,202	0,219	0,237	0,255	0,274	0,292	0,310	0,329
		0,37															
3456 motor	-	0,843	0,940	1,04	1,13	1,23	1,33	1,42	1,52	1,62	1,75	1,90	2,04	2,19	2,34	2,48	2,63
		1,1			1,5				2,2						-*		

Fan test laboratory AMCA 210 Test Chamber. Performance certified is for installation type D - Ducted inlet, Ducted outlet. Performance ratings do not include the effects of appurtenances (accessories-belt cover, pulley & belt).

Dimensions + Accessories Page 191 - 194;  
Sound power frequency spectrum L<sub>w</sub> Page 196 - 200.

The A-weighted sound ratings shown have been calculated per AMCA International Standard 301. Values shown are for inlet Lw(A) sound power levels for installation Type D: ducted inlet, ducted outlet. Ratings include the effects of duct end correction.

\* Sound power level with unlined metal duct were obtained from the test in the reverberant room. Data are not licensed by AMCA.



# Performance Curve

AXV 400-110-3, 60 Hz

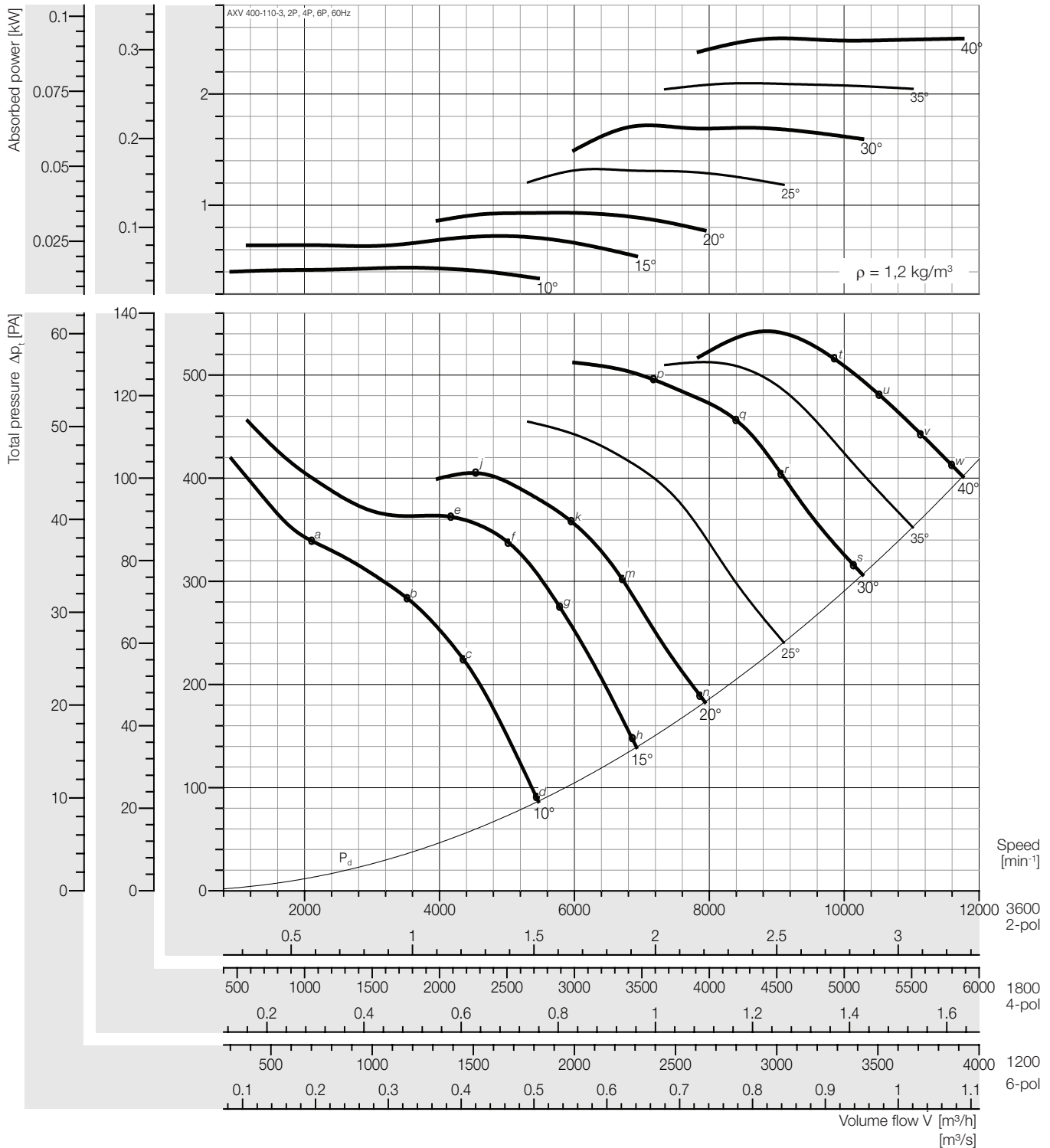

### Peak absorbed power [kW]

n [min <sup>-1</sup> ]	Pitch angle [°]						
	10	15	20	25	30	35	40
1200	0,016	0,027	0,035	0,049	0,064	0,078	0,093
Motor	0,12						
1800	0,055	0,090	0,116	0,165	0,214	0,262	0,313
Motor	0,12						
3600	0,438	0,722	0,932	1,322	1,715	2,098	2,501
Motor	0,55						

### Sound power level, Lwi(A) [dB(A)]

Lwi(A)	a	b	c	d	e	f	g	h	j	k	m	n	p	q	r	s	t	u	v	w
2P	97	99	96	97	101	97	99	101	102	101	102	102	99	102	102	104	103	103	104	104
4P	78	81	77	77	82	78	77	79	83	79	79	80	79	80	80	82	82	83	83	83
6P	66	71	67	66	71	67	66	67	71	68	68	68	68	69	69	70	71	72	72	72

Plastic Duct

Lwi(A)	a	b	c	d	e	f	g	h	j	k	m	n	p	q	r	s	t	u	v	w
2P	95	97	94	95	99	95	97	99	100	99	100	100	97	100	100	102	101	101	102	102
4P	76	79	75	75	80	76	75	77	81	77	77	78	77	78	78	80	80	81	81	81
6P	64	69	65	64	69	65	64	65	69	66	66	66	66	66	67	67	68	69	70	70

\* Unlined Metal Duct

Fan test laboratory AMCA 210 Test Chamber. Performance certified is for installation type D - Ducted inlet, Ducted outlet. Performance ratings do not include the effects of appurtenances (accessories-belt cover, pulley & belt).

Dimensions + Accessories Page 191 - 194;  
Sound power frequency spectrum L<sub>w(f)</sub> Page 196 - 200.

The A-weighted sound ratings shown have been calculated per AMCA International Standard 301. Values shown are for inlet LwiA sound power levels for installation Type D: ducted inlet, ducted outlet. Ratings include the effects of duct end correction.

\* Sound power level with unlined metal duct were obtained from the test in the reverberant room. Data are not licensed by AMCA.



# Performance Curve

AXV 400-110-6, 60 Hz

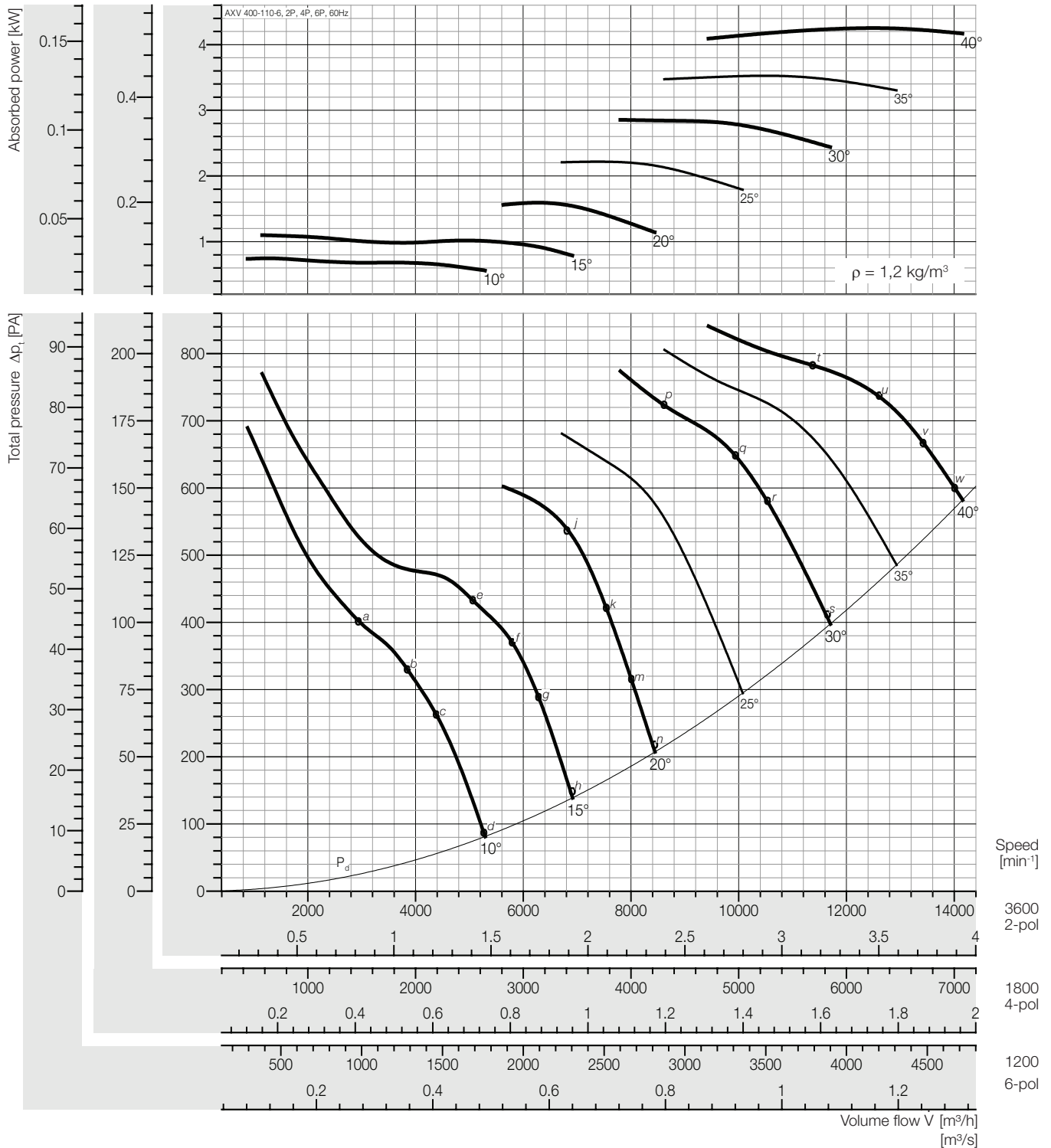

### Peak absorbed power [kW]

n [min <sup>-1</sup> ]	Pitch angle [°]						
	10	15	20	25	30	35	40
1200	0,028	0,041	0,059	0,082	0,106	0,131	0,157
Motor	0,12						0,18
1800	0,093	0,137	0,199	0,277	0,357	0,441	0,531
Motor	0,12	0,18	0,25	0,37	0,55		
3600	0,746	1,099	1,593	2,218	2,855	3,526	4,251
Motor	0,75	1,1	2,2	3,0	4,0		-

### Sound power level, Lwi(A) [dB(A)]

Lwi(A)	Pitch angle [°]																			
	a	b	c	d	e	f	g	h	j	k	m	n	p	q	r	s	t	u	v	w
2P	100	101	100	101	102	100	101	101	99	99	101	102	101	101	102	103	101	101	102	103
4P	82	84	82	82	85	81	81	81	79	80	81	82	81	82	82	84	83	83	84	85
6P	71	73	72	72	74	71	71	71	69	69	71	72	70	71	72	73	72	72	73	74
Plastic Duct																				
Lwi(A)	a	b	c	d	e	f	g	h	j	k	m	n	p	q	r	s	t	u	v	w
2P	98	99	98	99	100	98	99	99	97	97	99	100	99	99	100	101	99	99	100	101
4P	80	82	80	80	83	79	79	79	77	78	79	80	79	80	80	82	81	81	82	83
6P	69	71	70	70	72	69	69	69	67	67	69	70	68	69	70	71	70	70	71	72
* Unlined Metal Duct																				

Fan test laboratory AMCA 210 Test Chamber. Performance certified is for installation type D - Ducted inlet, Ducted outlet. Performance ratings do not include the effects of appurtenances (accessories-belt cover, pulley & belt).

Dimensions + Accessories Page 191 - 194;  
Sound power frequency spectrum L<sub>w</sub>(A) Page 196 - 200.

The A-weighted sound ratings shown have been calculated per AMCA International Standard 301. Values shown are for inlet Lwi(A) sound power levels for installation Type D: ducted inlet, ducted outlet. Ratings include the effects of duct end correction.

\* Sound power level with unlined metal duct were obtained from the test in the reverberant room. Data are not licensed by AMCA.



# Performance Curve

AXV 400-150-5, 60 Hz

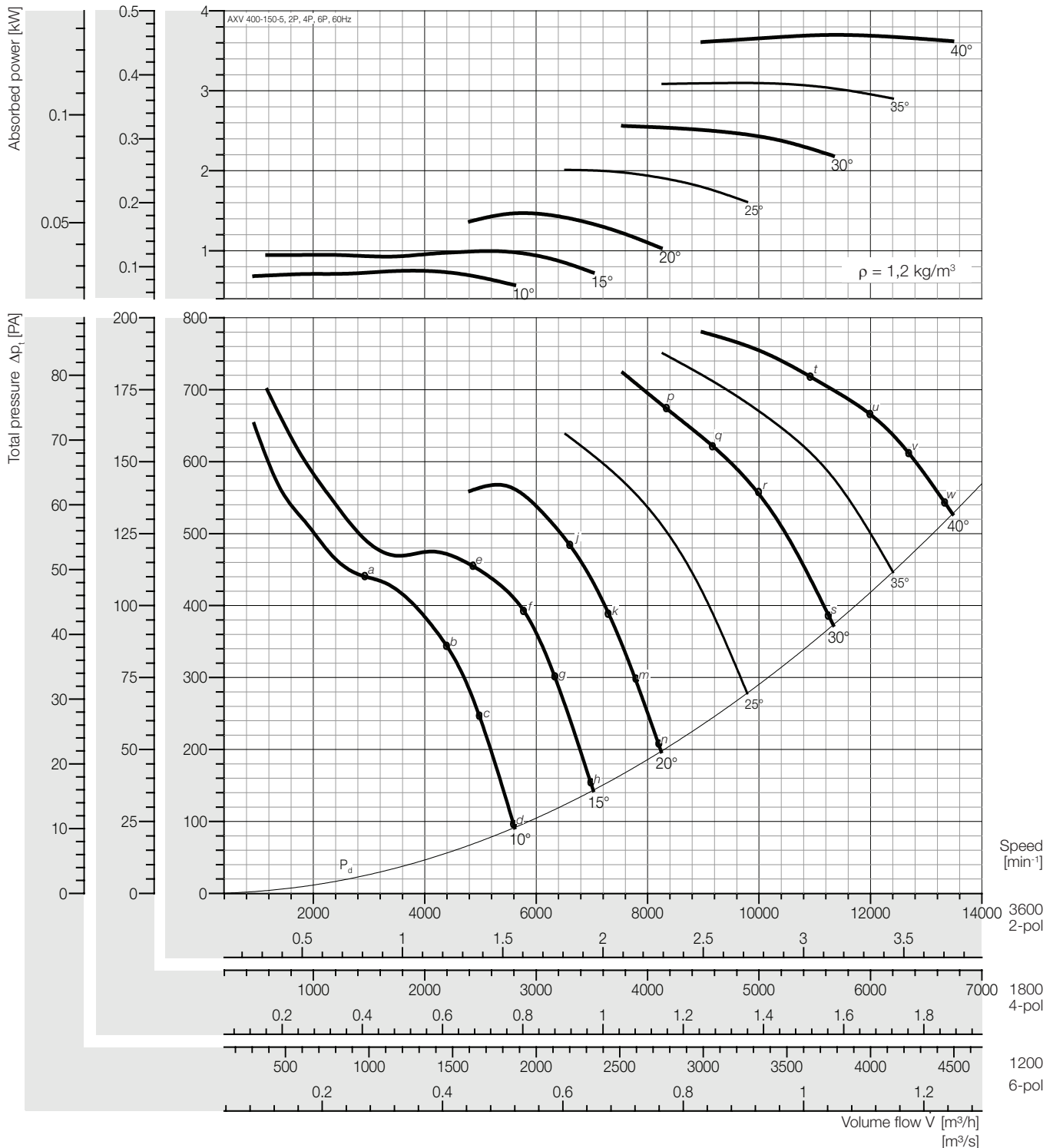

### Peak absorbed power [kW]

n [min <sup>-1</sup> ]	Pitch angle [°]						
	10	15	20	25	30	35	40
1200	0,028	0,037	0,054	0,074	0,095	0,115	0,137
Motor	0,12						0,18
1800	0,093	0,124	0,183	0,251	0,320	0,387	0,462
Motor	0,12	0,18	0,25	0,37	0,55		
3600	0,748	0,996	1,467	2,011	2,561	3,526	4,251
Motor	0,75	1,1	2,2	3,0	4,0	-	

### Sound power level, Lwi(A) [dB(A)]

Lwi(A)	a	b	c	d	e	f	g	h	j	k	m	n	p	q	r	s	t	u	v	w
2P	101	96	95	97	101	96	97	99	96	97	99	101	100	101	103	104	105	106	106	
4P	83	79	78	80	83	79	79	81	78	78	79	80	81	81	84	85	86	86	86	
6P	72	69	68	69	73	69	69	70	68	68	69	70	71	71	74	74	75	76	76	

Plastic Duct

Lwi(A)	a	b	c	d	e	f	g	h	j	k	m	n	p	q	r	s	t	u	v	w
2P	99	94	93	95	99	94	95	97	94	95	95	97	99	98	99	101	102	103	104	104
4P	81	77	76	78	81	77	77	79	76	76	77	78	79	79	79	82	83	84	84	84
6P	70	67	66	67	71	67	67	68	66	66	67	68	69	69	69	72	72	73	74	74

\* Unlined Metal Duct

Fan test laboratory AMCA 210 Test Chamber. Performance certified is for installation type D - Ducted inlet, Ducted outlet. Performance ratings do not include the effects of appurtenances (accessories-belt cover, pulley & belt).

Dimensions + Accessories Page 191 - 194;  
Sound power frequency spectrum L<sub>w</sub>(A) Page 196 - 200.

The A-weighted sound ratings shown have been calculated per AMCA International Standard 301. Values shown are for inlet Lwi(A) sound power levels for installation Type D: ducted inlet, ducted outlet. Ratings include the effects of duct end correction.

\* Sound power level with unlined metal duct were obtained from the test in the reverberant room. Data are not licensed by AMCA.



# Performance Curve

AXV 400-150-7, 60 Hz

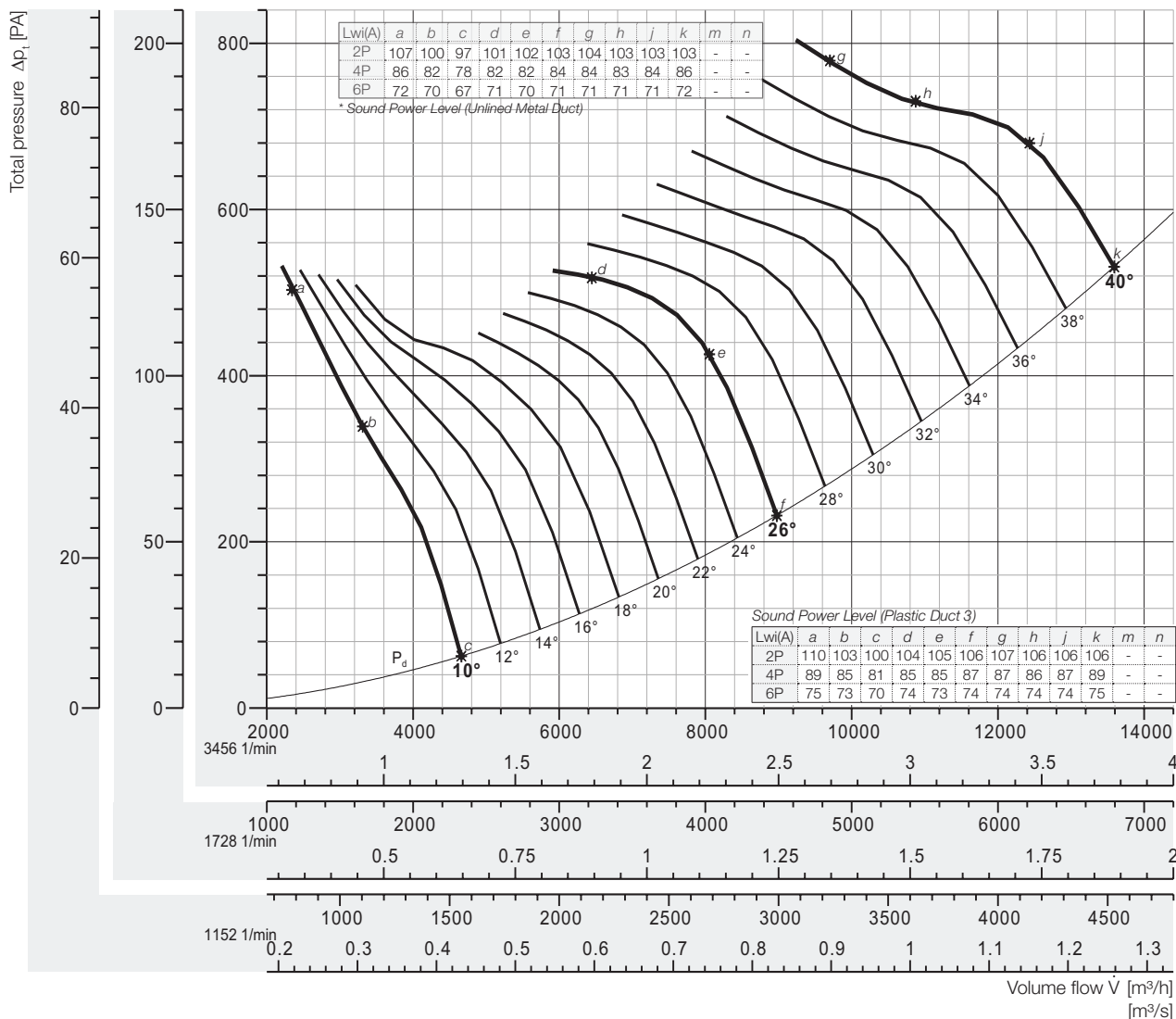
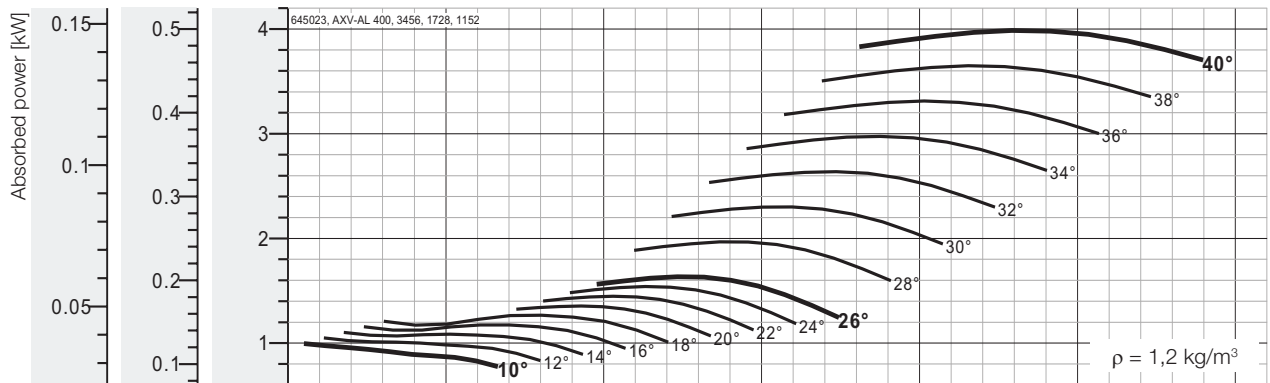

## Peak absorbed power [kW]

\* Out of Range

n [min <sup>-1</sup> ]	Pitch angle [°]																
	8	10	12	14	16	18	20	22	24	26	28	30	32	34	36	38	40
1152 motor	-	0,037	0,039	0,041	0,043	0,047	0,050	0,054	0,057	0,061	0,073	0,085	0,098	0,110	0,123	0,135	0,148
1728 motor	-	0,124	0,131	0,138	0,147	0,158	0,169	0,181	0,193	0,204	0,246	0,288	0,330	0,372	0,414	0,456	0,498
3456 motor	-	0,995	1,05	1,10	1,17	1,27	1,35	1,45	1,54	1,63	1,97	2,30	2,64	2,98	3,31	3,65	3,99

Fan test laboratory AMCA 210 Test Chamber. Performance certified is for installation type D - Ducted inlet, Ducted outlet. Performance ratings do not include the effects of appurtenances (accessories-belt cover, pulley & belt).

Dimensions + Accessories Page 191 - 194;  
Sound power frequency spectrum L<sub>w</sub> Page 196 - 200.

The A-weighted sound ratings shown have been calculated per AMCA International Standard 301. Values shown are for inlet LwiA sound power levels for installation Type D: ducted inlet, ducted outlet. Ratings include the effects of duct end correction.

\* Sound power level with unlined metal duct were obtained from the test in the reverberant room. Data are not licensed by AMCA.





# Performance Curve

AXV 400-150-10, 60 Hz

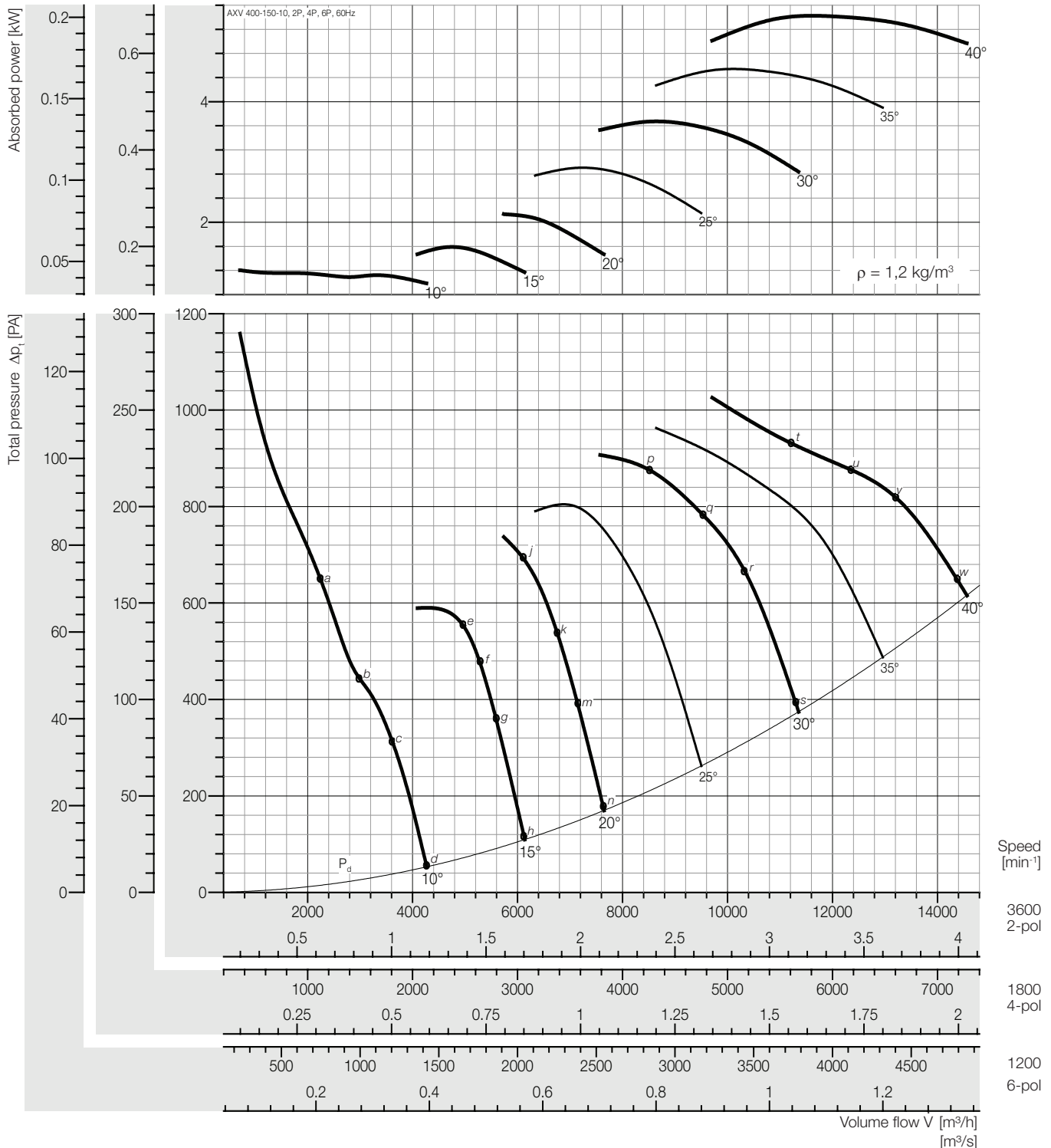

### Peak absorbed power [kW]

n [min <sup>-1</sup> ]	Pitch angle [°]						
	10	15	20	25	30	35	40
1200	0,045	0,059	0,079	0,107	0,136	0,168	0,201
Motor						0,18	0,25
1800	0,151	0,199	0,267	0,363	0,458	0,568	0,678
Motor	0,18	0,25	0,37	0,55		0,75	
3600	1,204	1,590	2,134	2,900	3,668	4,543	5,421
Motor	1,5	2,2	3,0		4,0	-	

### Sound power level, Lwi(A) [dB(A)]

Lwi(A)	a	b	c	d	e	f	g	h	j	k	m	n	p	q	r	s	t	u	v	w
2P	102	100	99	99	99	97	98	99	96	98	99	100	100	101	101	102	104	103	104	104
4P	83	83	82	81	81	80	81	82	79	80	82	83	82	83	83	85	85	85	86	86
6P	72	72	71	71	71	70	70	71	68	70	71	72	71	71	72	74	75	75	76	76

Plastic Duct

Lwi(A)	a	b	c	d	e	f	g	h	j	k	m	n	p	q	r	s	t	u	v	w
2P	100	98	97	97	97	95	96	97	94	96	97	98	98	98	99	100	102	101	102	102
4P	81	81	80	79	79	78	79	80	77	78	80	81	80	81	81	83	83	83	84	84
6P	70	70	69	69	69	68	68	71	68	70	71	72	69	69	70	72	73	73	74	74

\* Unlined Metal Duct

Fan test laboratory AMCA 210 Test Chamber. Performance certified is for installation type D - Ducted inlet, Ducted outlet. Performance ratings do not include the effects of appurtenances (accessories-belt cover, pulley & belt).

Dimensions + Accessories Page 191 ~ 194;  
Sound power frequency spectrum L<sub>w(f)</sub> Page 196 ~ 200.

The A-weighted sound ratings shown have been calculated per AMCA International Standard 301. Values shown are for inlet LwiA sound power levels for installation Type D: ducted inlet, ducted outlet. Ratings include the effects of duct end correction.

\* Sound power level with unlined metal duct were obtained from the test in the reverberant room. Data are not licensed by AMCA.



# Performance Curve

## AXV 450-110-3, 60 Hz

## wolter

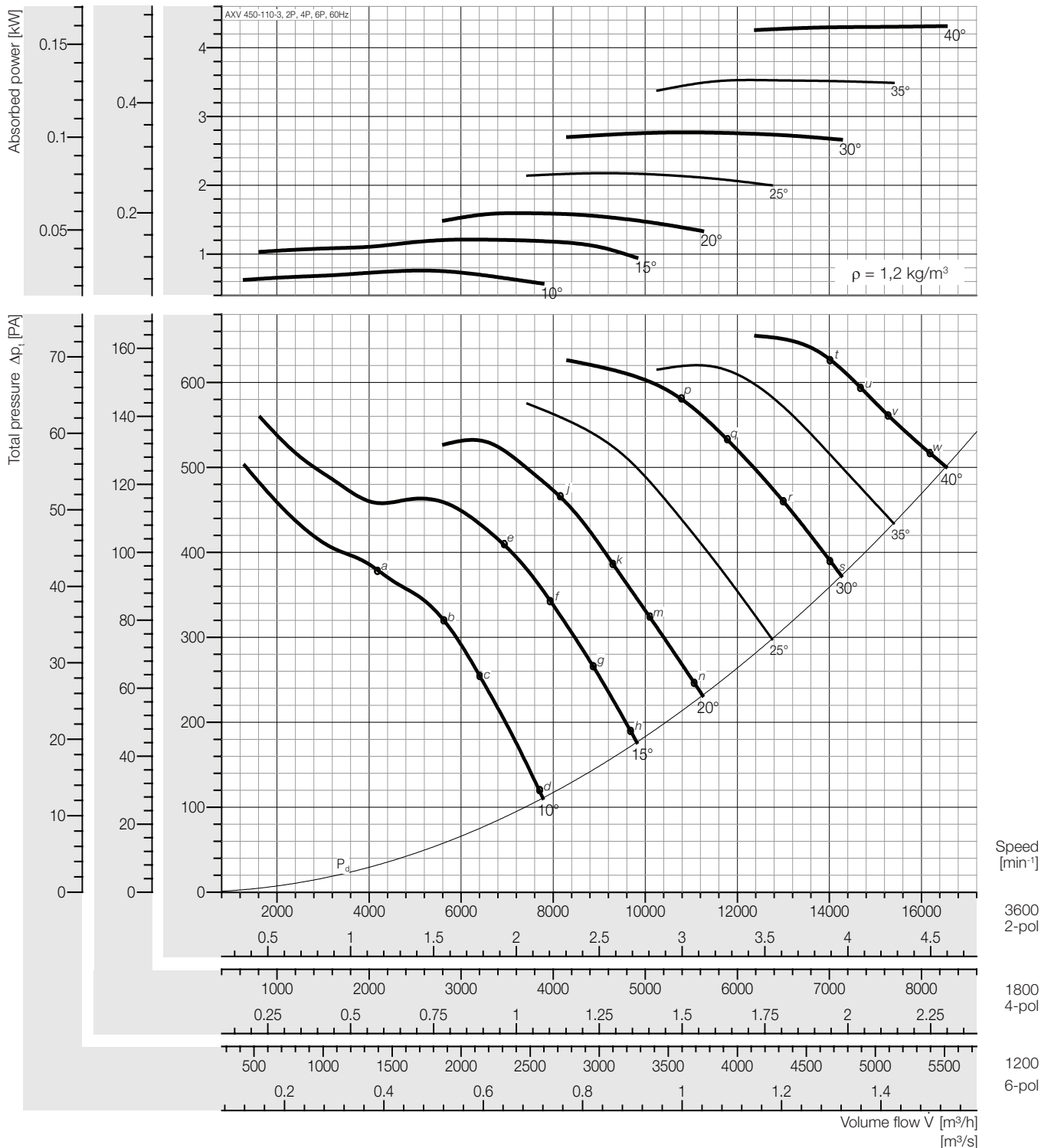

### Peak absorbed power [kW]

n [min <sup>-1</sup> ]	Pitch angle [°]						
	10	15	20	25	30	35	40
1200	0,028	0,045	0,059	0,081	0,103	0,131	0,160
Motor	0,18						
1800	0,095	0,151	0,199	0,272	0,346	0,441	0,539
Motor	0,18		0,25	0,37		0,55	
3600	0,759	1,212	1,594	2,175	2,769	3,529	4,314
Motor	1,1	1,5	2,2		3,0	4,0	-

### Sound power level, Lwi(A) [dB(A)]

Lwi(A)	a	b	c	d	e	f	g	h	j	k	m	n	p	q	r	s	t	u	v	w
2P	102	100	103	101	96	96	99	101	98	101	104	104	102	103	104	105	103	103	104	104
4P	84	83	86	82	78	78	79	80	79	80	82	82	83	83	83	85	84	84	84	84
6P	73	73	76	72	67	67	68	70	68	69	70	71	72	72	72	73	73	74	74	74
Plastic Duct																				
Lwi(A)	a	b	c	d	e	f	g	h	j	k	m	n	p	q	r	s	t	u	v	w
2P	100	98	101	99	94	94	97	99	96	99	102	102	100	101	102	103	101	101	102	102
4P	82	81	84	80	76	76	77	78	77	78	80	80	81	81	81	83	82	82	82	82
6P	71	71	74	70	65	65	66	68	66	67	68	69	70	70	70	71	71	72	72	72
* Unlined Metal Duct																				

Fan test laboratory AMCA 210 Test Chamber. Performance certified is for installation type D - Ducted inlet, Ducted outlet. Performance ratings do not include the effects of appurtenances (accessories-belt cover, pulley & belt).

Dimensions + Accessories Page 191 - 194;  
Sound power frequency spectrum L<sub>w</sub> Page 196 - 200.

The A-weighted sound ratings shown have been calculated per AMCA International Standard 301. Values shown are for inlet Lwi(A) sound power levels for installation Type D: ducted inlet, ducted outlet. Ratings include the effects of duct end correction.

\* Sound power level with unlined metal duct were obtained from the test in the reverberant room. Data are not licensed by AMCA.



# Performance Curve

AXV 450-110-6, 2P, 4P, 6P, 60 Hz

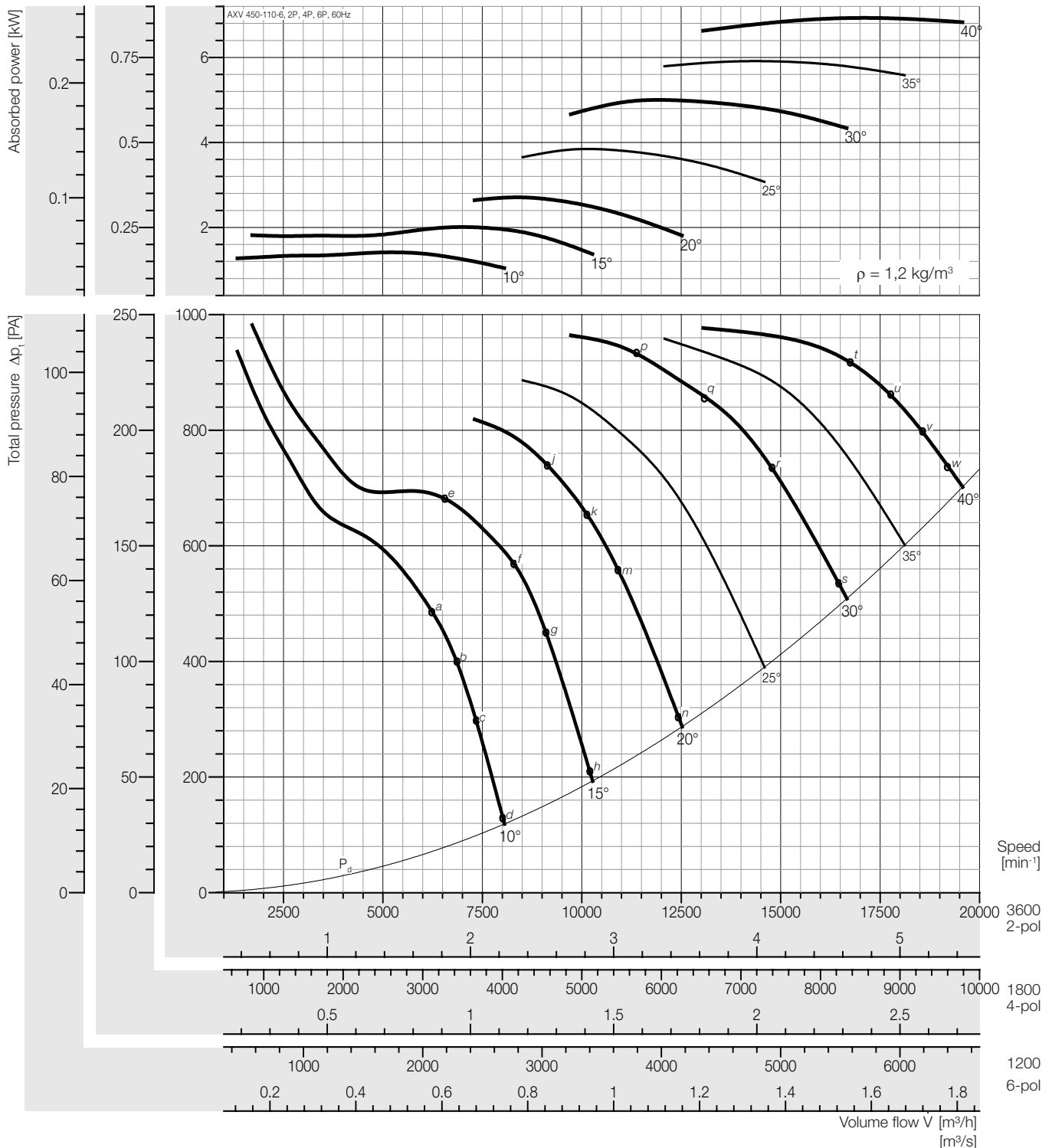

### Peak absorbed power [kW]

n [min <sup>-1</sup> ]	Pitch angle [°]						
	10	15	20	25	30	35	40
1200	0,052	0,074	0,100	0,142	0,185	0,219	0,257
Motor	0,18						
1800	0,177	0,250	0,339	0,480	0,625	0,739	0,866
Motor	0,18	0,25	0,37	0,55	0,75	1,1	
3600	1,414	2,001	2,709	3,841	5,000	5,911	6,928
Motor	1,5	2,2	3,0	4,0	-		

### Sound power level, Lwi(A) [dB(A)]

Lwi(A)	a	b	c	d	e	f	g	h	j	k	m	n	p	q	r	s	t	u	v	w
2P	100	98	99	101	105	100	101	102	101	102	102	102	100	102	102	103	114	115	115	115
4P	83	80	81	82	87	81	82	83	82	83	83	85	82	83	84	85	92	93	93	93
6P	73	70	71	72	76	71	71	73	72	73	73	76	72	72	72	74	82	84	83	83

Plastic Duct

Lwi(A)	a	b	c	d	e	f	g	h	j	k	m	n	p	q	r	s	t	u	v	w
2P	98	96	97	99	103	98	99	100	99	100	100	100	98	100	100	101	110	113	113	113
4P	81	78	79	80	85	79	80	81	80	81	81	83	80	81	82	83	90	91	91	91
6P	72	68	69	70	74	69	69	71	70	71	71	74	70	70	70	72	80	72	81	81

\* Unlined Metal Duct

Fan test laboratory AMCA 210 Test Chamber. Performance certified is for installation type D - Ducted inlet, Ducted outlet. Performance ratings do not include the effects of appurtenances (accessories-belt cover, pulley & belt).

Dimensions + Accessories Page 191 ~ 194;  
Sound power frequency spectrum L<sub>w</sub>(A) Page 196 ~ 200.

The A-weighted sound ratings shown have been calculated per AMCA International Standard 301. Values shown are for inlet LwiA sound power levels for installation Type D: ducted inlet, ducted outlet. Ratings include the effects of duct end correction.

\* Sound power level with unlined metal duct were obtained from the test in the reverberant room. Data are not licensed by AMCA.



# Performance Curve

AXV 450-150-5, 60 Hz

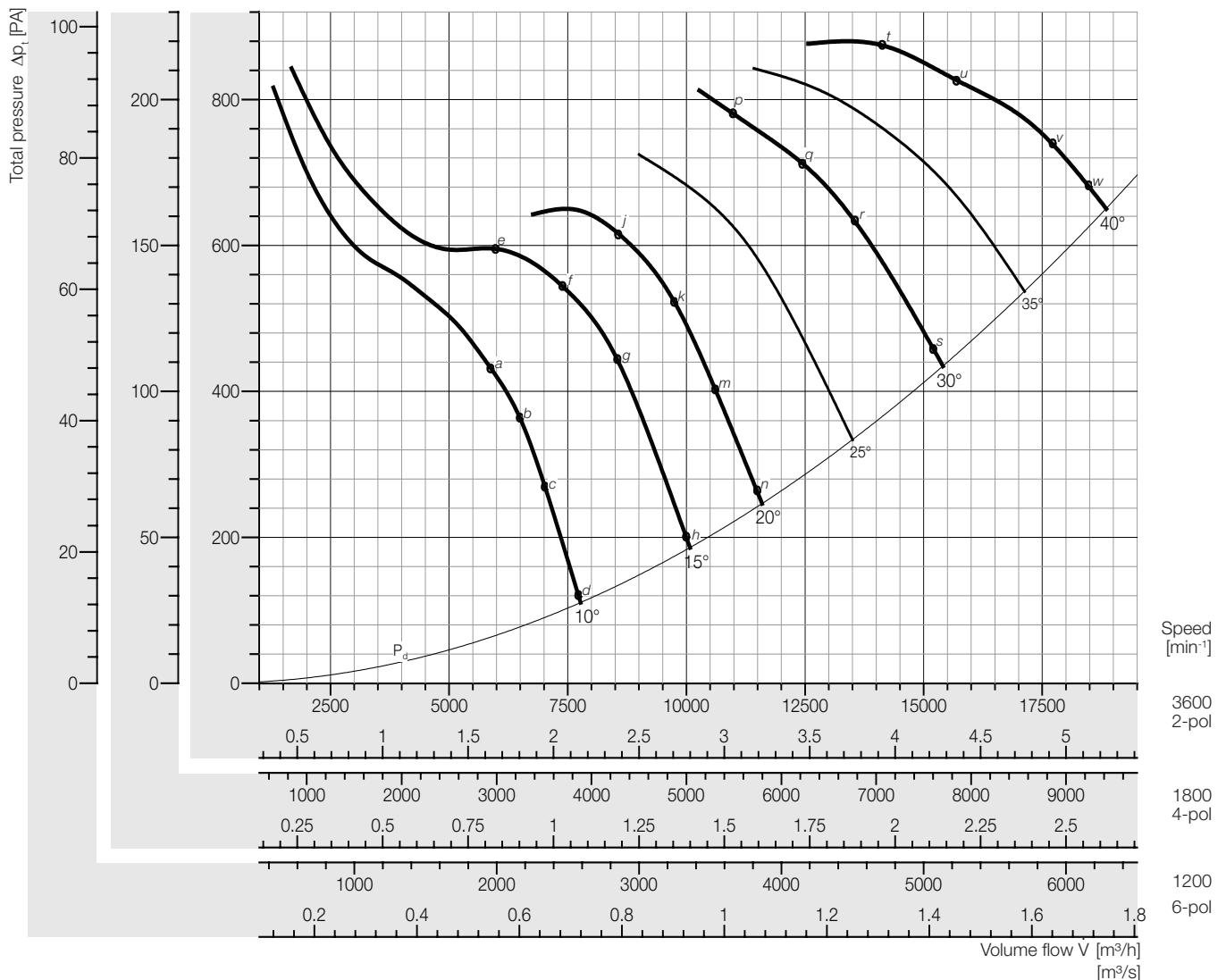
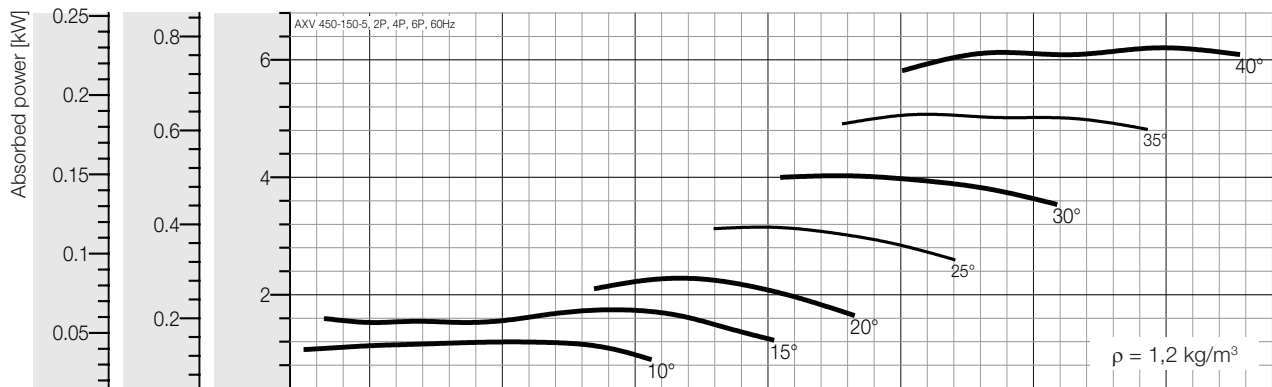

### Peak absorbed power [kW]

n [min <sup>-1</sup> ]	Pitch angle [°]						
	10	15	20	25	30	35	40
1200	0,044	0,065	0,085	0,117	0,149	0,188	0,230
Motor	0,18					0,25	
1800	0,149	0,218	0,285	0,394	0,503	0,633	0,776
Motor	0,18	0,25	0,37	0,55		0,75	1,1
3600	1,195	1,743	2,282	3,152	4,027	5,067	6,206
Motor	1,5	2,2	3,0	4,0	-		

### Sound power level, Lwi(A) [dB(A)]

Lwi(A)	a	b	c	d	e	f	g	h	j	k	m	n	p	q	r	s	t	u	v	w
2P	100	99	100	101	107	101	98	101	99	99	101	102	102	103	104	104	103	103	103	104
4P	84	82	82	83	89	84	80	83	82	81	82	84	84	84	84	85	85	85	85	86
6P	73	71	72	73	79	74	71	73	72	71	72	73	74	74	74	75	75	75	75	75

Plastic Duct

Lwi(A)	a	b	c	d	e	f	g	h	j	k	m	n	p	q	r	s	t	u	v	w
2P	98	97	98	99	105	99	96	99	97	97	99	100	100	101	102	102	101	101	101	102
4P	82	80	80	81	87	82	78	81	80	79	80	82	82	82	82	83	83	83	83	84
6P	71	69	70	71	77	72	69	71	70	69	70	71	72	72	72	73	73	73	73	73

\* Unlined Metal Duct

Fan test laboratory AMCA 210 Test Chamber. Performance certified is for installation type D - Ducted inlet, Ducted outlet. Performance ratings do not include the effects of appurtenances (accessories-belt cover, pulley & belt).

Dimensions + Accessories Page 191 - 194;  
Sound power frequency spectrum L<sub>w</sub> Page 196 - 200.

The A-weighted sound ratings shown have been calculated per AMCA International Standard 301. Values shown are for inlet LwiA sound power levels for installation Type D: ducted inlet, ducted outlet. Ratings include the effects of duct end correction.

\* Sound power level with unlined metal duct were obtained from the test in the reverberant room. Data are not licensed by AMCA.



# Performance Curve

AXV 450-150-7, 60 Hz

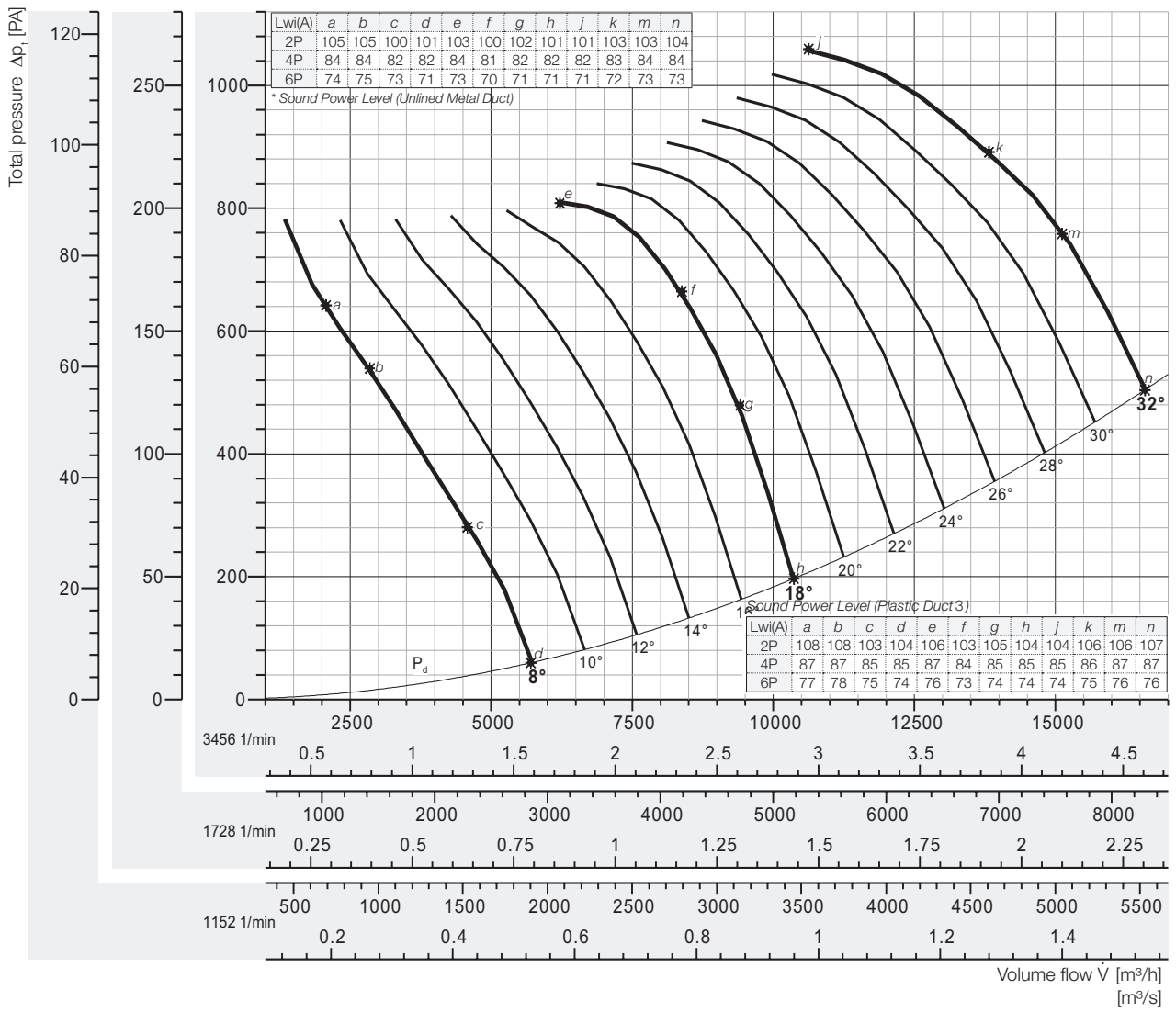
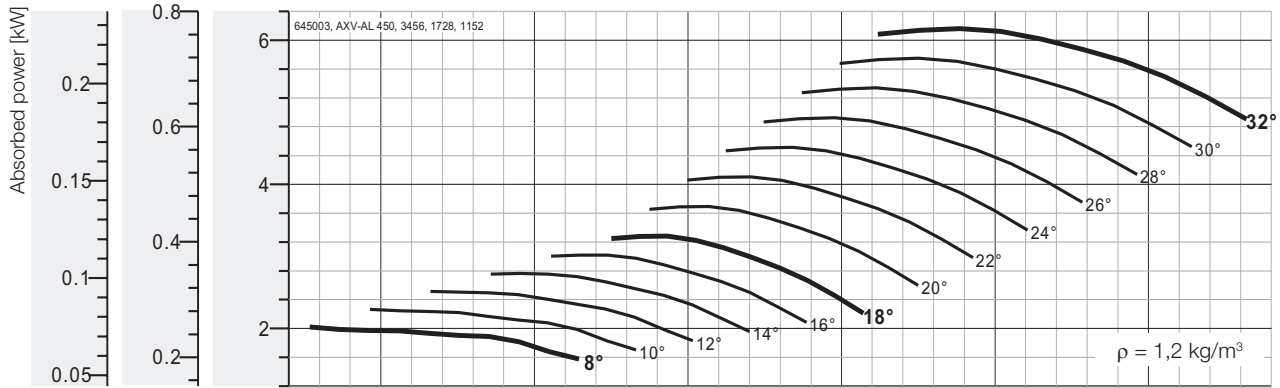

## Peak absorbed power [kW]

\* Out of Range

n [min <sup>-1</sup> ]	Pitch angle [°]																
	8	10	12	14	16	18	20	22	24	26	28	30	32	34	36	38	40
1152 motor	0,075	0,084	0,093	0,102	0,112	0,121	0,137	0,152	0,167	0,182	0,198	0,213	0,228	-	-	-	-
1728 motor	0,252	0,283	0,314	0,345	0,377	0,410	0,461	0,513	0,564	0,616	0,667	0,719	0,770	-	-	-	-
3456 motor	2,02	2,26	2,51	2,76	3,02	3,28	3,69	4,10	4,52	4,93	5,34	5,75	6,16	-	-	-	-

Fan test laboratory AMCA 210 Test Chamber. Performance certified is for installation type D - Ducted inlet, Ducted outlet. Performance ratings do not include the effects of appurtenances (accessories-belt cover, pulley & belt).

The A-weighted sound ratings shown have been calculated per AMCA International Standard 301. Values shown are for inlet Lw(A) sound power levels for installation Type D: ducted inlet, ducted outlet. Ratings include the effects of duct end correction.

Dimensions + Accessories Page 191 - 194;  
Sound power frequency spectrum L<sub>w</sub> Page 196 - 200.

\* Sound power level with unlined metal duct were obtained from the test in the reverberant room.  
Data are not licensed by AMCA.



# Performance Curve

AXV 450-150-10, 60 Hz

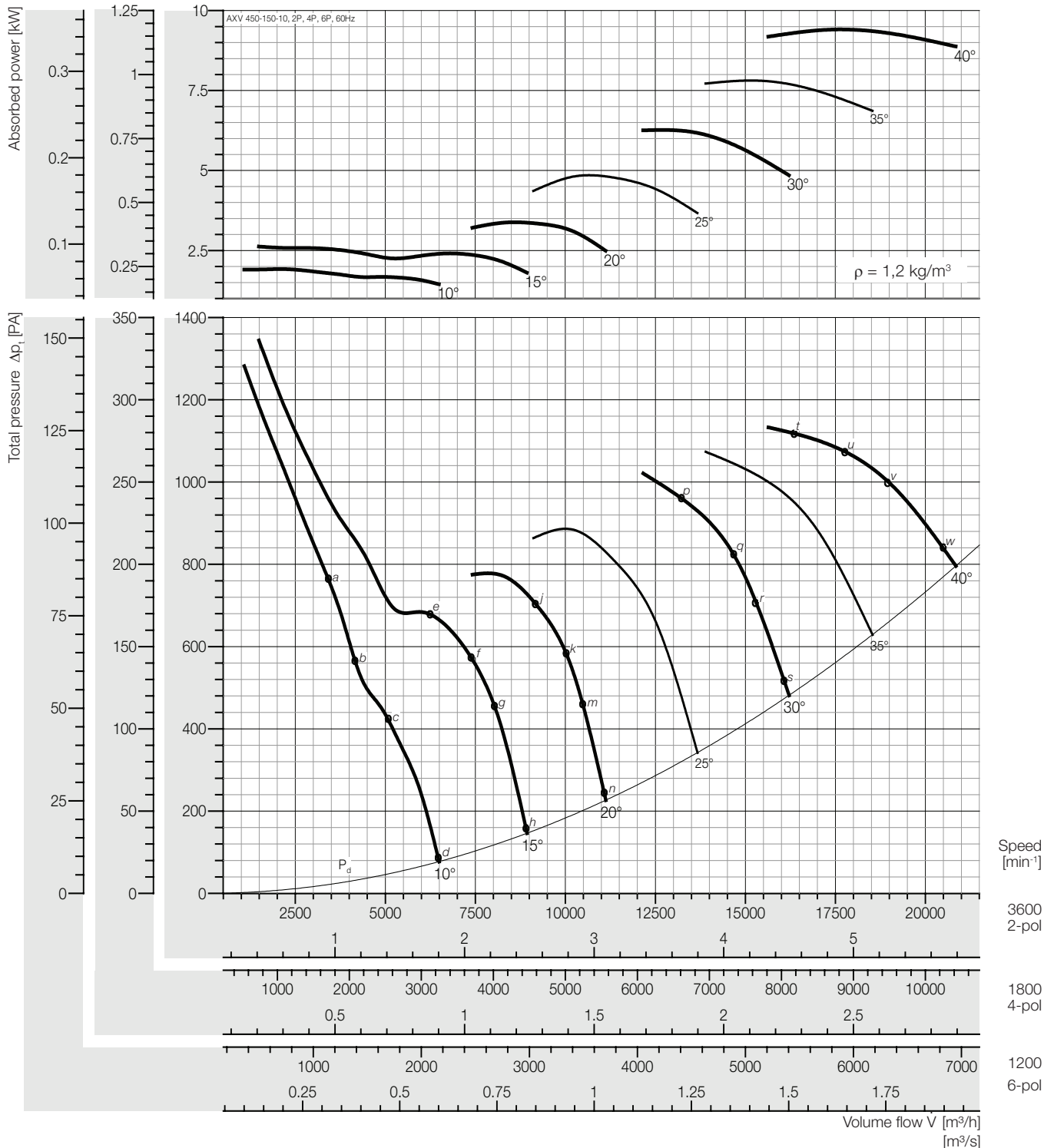

### Peak absorbed power [kW]

n [min <sup>-1</sup> ]	Pitch angle [°]						
	10	15	20	25	30	35	40
1200	0,071	0,089	0,125	0,180	0,234	0,290	0,348
Motor	0,18			0,25	0,37		
1800	0,240	0,301	0,422	0,607	0,790	0,979	1,175
Motor	0,25	0,37	0,55	0,75	1,1		1,5
3600	1,916	2,407	3,375	4,852	6,321	7,833	9,398
Motor	2,2	3,0	4,0	-			

### Sound power level, Lwi(A) [dB(A)]

Lwi(A)	a	b	c	d	e	f	g	h	j	k	m	n	p	q	r	s	t	u	v	w
2P	105	106	105	103	106	103	101	104	103	102	102	103	105	105	105	105	108	109	109	110
4P	87	88	88	86	89	86	84	86	86	85	85	87	88	88	87	88	90	90	91	92
6P	76	77	78	76	78	76	74	76	75	75	75	76	78	78	77	78	79	80	80	81

Plastic Duct

Lwi(A)	a	b	c	d	e	f	g	h	j	k	m	n	p	q	r	s	t	u	v	w
2P	103	104	103	101	104	101	99	102	101	100	100	101	103	103	103	103	106	107	107	108
4P	85	86	86	84	87	84	82	84	84	83	83	85	86	86	85	86	88	88	89	90
6P	74	75	76	74	76	74	72	74	73	73	73	74	76	76	75	76	77	78	78	79

\* Unlined Metal Duct

Fan test laboratory AMCA 210 Test Chamber. Performance certified is for installation type D - Ducted inlet, Ducted outlet. Performance ratings do not include the effects of appurtenances (accessories-belt cover, pulley & belt).

Dimensions + Accessories Page 191 - 194;  
Sound power frequency spectrum L<sub>w</sub>(f) Page 196 - 200.

The A-weighted sound ratings shown have been calculated per AMCA International Standard 301. Values shown are for inlet Lwi(A) sound power levels for installation Type D: ducted inlet, ducted outlet. Ratings include the effects of duct end correction.

\* Sound power level with unlined metal duct were obtained from the test in the reverberant room. Data are not licensed by AMCA.



# Performance Curve

AXV 500-110-3, 60 Hz

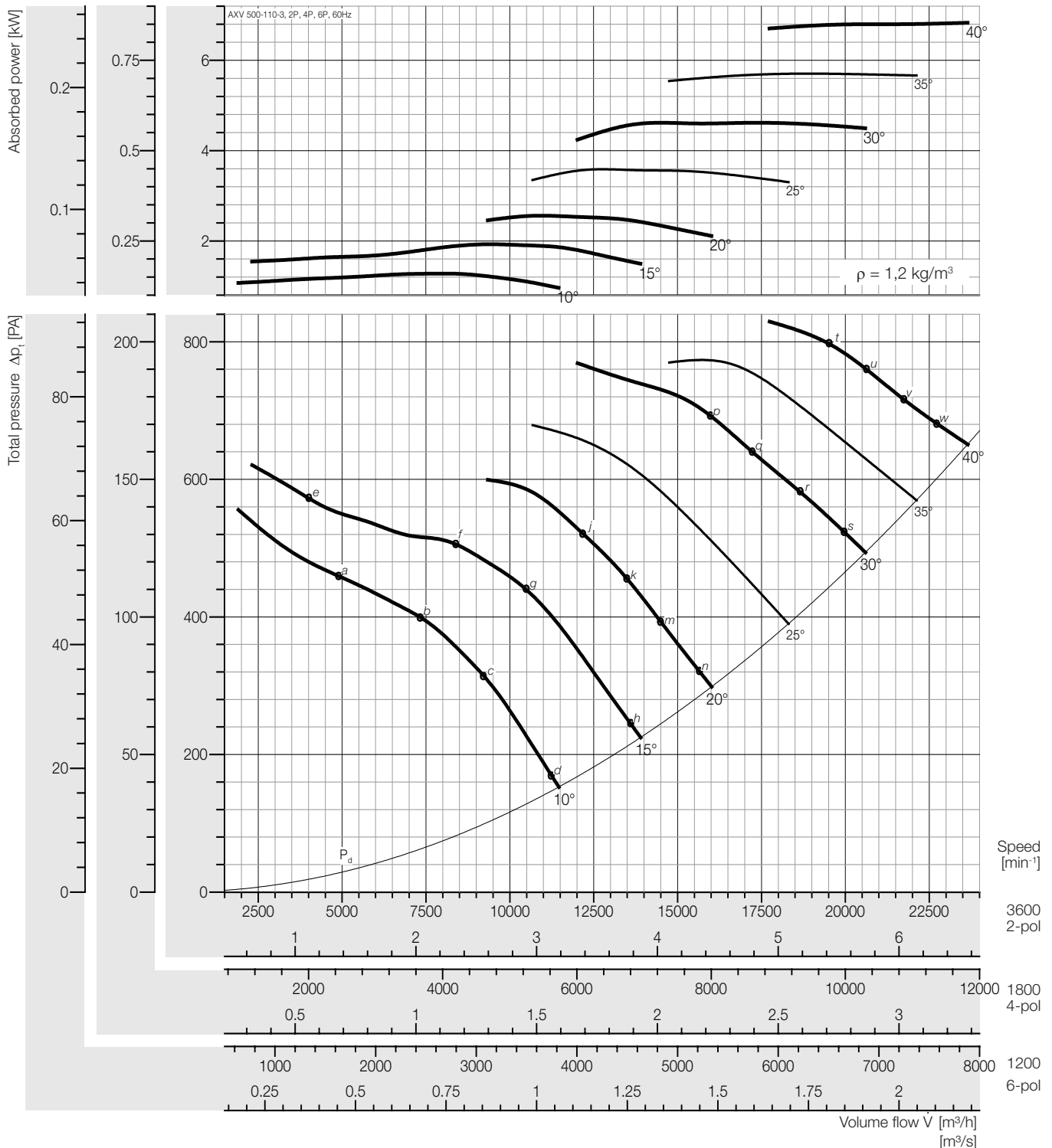

### Peak absorbed power [kW]

n [min <sup>-1</sup> ]	Pitch angle [°]						
	10	15	20	25	30	35	40
1200	0,047	0,071	0,095	0,133	0,171	0,211	0,253
Motor	0,18					0,25	0,37
1800	0,160	0,240	0,320	0,448	0,557	0,713	0,854
Motor	0,18	0,25	0,37	0,55	0,75		1,1
3600	1,277	1,917	2,560	3,581	4,616	5,706	6,832
Motor	1,5	2,2	3,0	4,0	-		

### Sound power level, Lwi(A) [dB(A)]

Lwi(A)	a	b	c	d	e	f	g	h	j	k	m	n	p	q	r	s	t	u	v	w
2P	106	105	101	101	104	105	101	101	102	101	102	102	104	104	104	105	106	106	107	107
4P	87	88	84	83	86	88	83	83	84	83	84	84	86	86	86	86	89	89	89	89
6P	76	77	74	73	75	77	73	73	73	73	73	73	75	75	75	75	79	79	79	79

Plastic Duct

Lwi(A)	a	b	c	d	e	f	g	h	j	k	m	n	p	q	r	s	t	u	v	w
2P	104	103	99	99	102	103	99	99	100	99	100	100	102	102	102	103	104	104	105	105
4P	85	86	82	81	84	86	81	81	82	81	82	82	84	84	84	84	87	87	87	87
6P	74	75	72	71	73	75	71	71	71	71	71	71	73	73	73	73	77	77	77	77

\* Unlined Metal Duct

Fan test laboratory AMCA 210 Test Chamber. Performance certified is for installation type D - Ducted inlet, Ducted outlet. Performance ratings do not include the effects of appurtenances (accessories-belt cover, pulley & belt).

Dimensions + Accessories Page 191 - 194;  
Sound power frequency spectrum L<sub>w(f)</sub> Page 196 - 200.

The A-weighted sound ratings shown have been calculated per AMCA International Standard 301. Values shown are for inlet LwiA sound power levels for installation Type D: ducted inlet, ducted outlet. Ratings include the effects of duct end correction.

\* Sound power level with unlined metal duct were obtained from the test in the reverberant room. Data are not licensed by AMCA.



# Performance Curve

AXV 500-110-6, 60 Hz

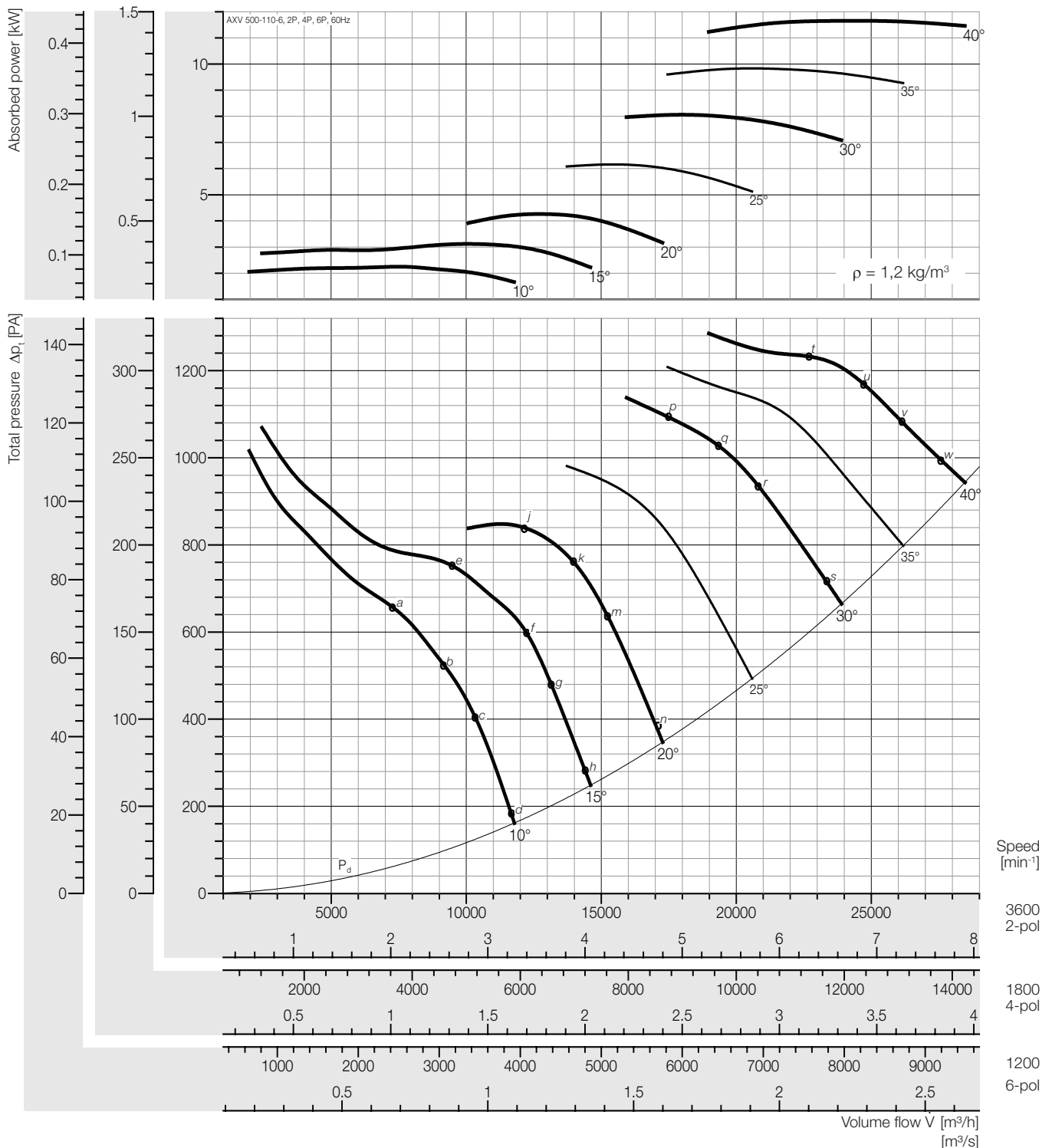

### Peak absorbed power [kW]

n [min <sup>-1</sup> ]	Pitch angle [°]						
	10	15	20	25	30	35	40
1200	0,083	0,115	0,158	0,228	0,298	0,364	0,432
Motor	0,18			0,25	0,37		0,55
1800	0,281	0,389	0,533	0,770	1,007	1,229	1,457
Motor	0,37	0,55		1,1	1,5		
3600	2,249	3,114	4,262	6,160	8,059	9,834	11,65
Motor	3,0	4,0	-				

### Sound power level, Lwi(A) [dB(A)]

Lwi(A)	a	b	c	d	e	f	g	h	j	k	m	n	p	q	r	s	t	u	v	w
2P	108	106	102	104	110	102	103	104	108	104	103	104	106	106	106	107	108	108	108	109
4P	91	89	85	86	92	85	85	86	91	86	86	86	88	88	88	89	90	90	90	91
6P	80	79	75	76	81	75	75	76	80	76	75	76	77	77	77	78	80	80	80	80

Plastic Duct

Lwi(A)	a	b	c	d	e	f	g	h	j	k	m	n	p	q	r	s	t	u	v	w
2P	106	104	100	102	108	100	101	102	106	102	101	102	104	104	104	105	106	106	106	107
4P	89	87	83	84	90	83	83	84	89	84	84	84	86	86	86	87	88	88	88	89
6P	78	77	73	74	79	73	73	74	78	74	73	74	75	75	75	76	78	78	78	78

\* Unlined Metal Duct

Fan test laboratory AMCA 210 Test Chamber. Performance certified is for installation type D - Ducted inlet, Ducted outlet. Performance ratings do not include the effects of appurtenances (accessories-belt cover, pulley & belt).

Dimensions + Accessories Page 191 - 194;  
Sound power frequency spectrum L<sub>w</sub>(f) Page 196 - 200.

The A-weighted sound ratings shown have been calculated per AMCA International Standard 301. Values shown are for inlet LwiA sound power levels for installation Type D: ducted inlet, ducted outlet. Ratings include the effects of duct end correction.

\* Sound power level with unlined metal duct were obtained from the test in the reverberant room. Data are not licensed by AMCA.





# Performance Curve

AXV 500-150-5, 60 Hz

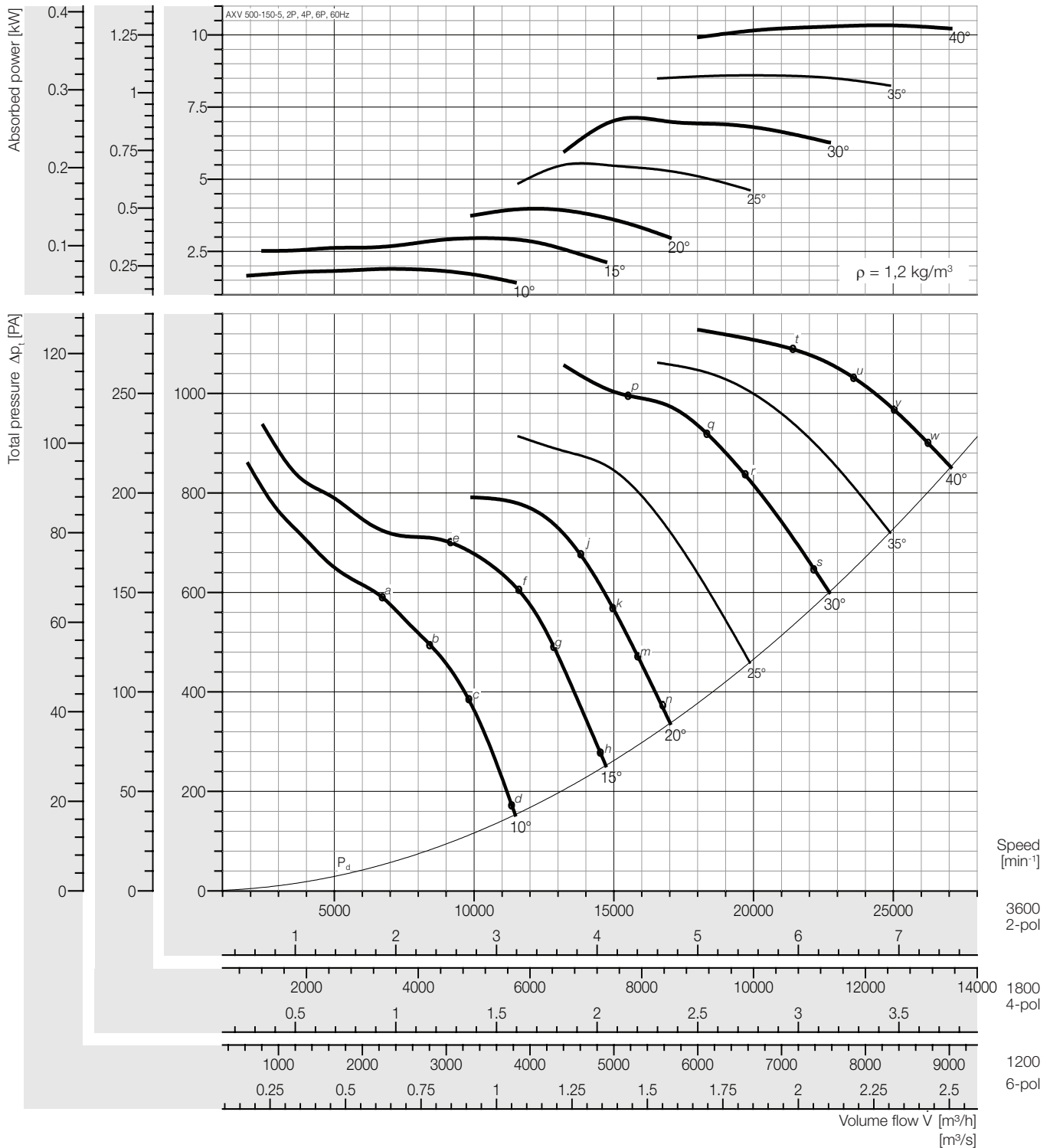

### Peak absorbed power [kW]

n [min <sup>-1</sup> ]	Pitch angle [°]						
	10	15	20	25	30	35	40
1200	0,070	0,110	0,147	0,205	0,263	0,318	0,383
Motor	0,18			0,25	0,37		0,55
1800	0,237	0,370	0,498	0,691	0,888	1,075	1,291
Motor	0,25	0,37	0,55	0,75	1,1		1,5
3600	1,894	2,959	3,981	5,530	7,106	8,599	10,33
Motor	2,2	3,0	4,0	-			

### Sound power level, Lwi(A) [dB(A)]

Lwi(A)	a	b	c	d	e	f	g	h	j	k	m	n	p	q	r	s	t	u	v	w
2P	108	106	104	104	109	104	104	106	107	108	109	109	106	107	108	109	108	108	108	109
4P	90	89	86	86	92	86	85	87	87	88	89	89	88	89	89	90	90	91	91	91
6P	79	79	75	75	81	75	74	76	76	76	77	77	77	78	78	79	80	80	80	80

Plastic Duct

Lwi(A)	a	b	c	d	e	f	g	h	j	k	m	n	p	q	r	s	t	u	v	w
2P	106	104	102	102	107	102	102	104	105	106	107	107	104	105	106	107	106	106	106	107
4P	88	87	84	84	90	84	83	85	85	86	87	87	86	87	87	88	88	89	89	89
6P	77	77	73	73	79	73	72	74	74	74	75	75	75	76	76	77	78	78	78	78

\* Unlined Metal Duct

Fan test laboratory AMCA 210 Test Chamber. Performance certified is for installation type D - Ducted inlet, Ducted outlet. Performance ratings do not include the effects of appurtenances (accessories-belt cover, pulley & belt).

Dimensions + Accessories Page 191 ~ 194;  
Sound power frequency spectrum L<sub>w(f)</sub> Page 196 ~ 200.

The A-weighted sound ratings shown have been calculated per AMCA International Standard 301. Values shown are for inlet LwiA sound power levels for installation Type D: ducted inlet, ducted outlet. Ratings include the effects of duct end correction.

\* Sound power level with unlined metal duct were obtained from the test in the reverberant room. Data are not licensed by AMCA.



# Performance Curve

AXV 500-150-7, 60 Hz

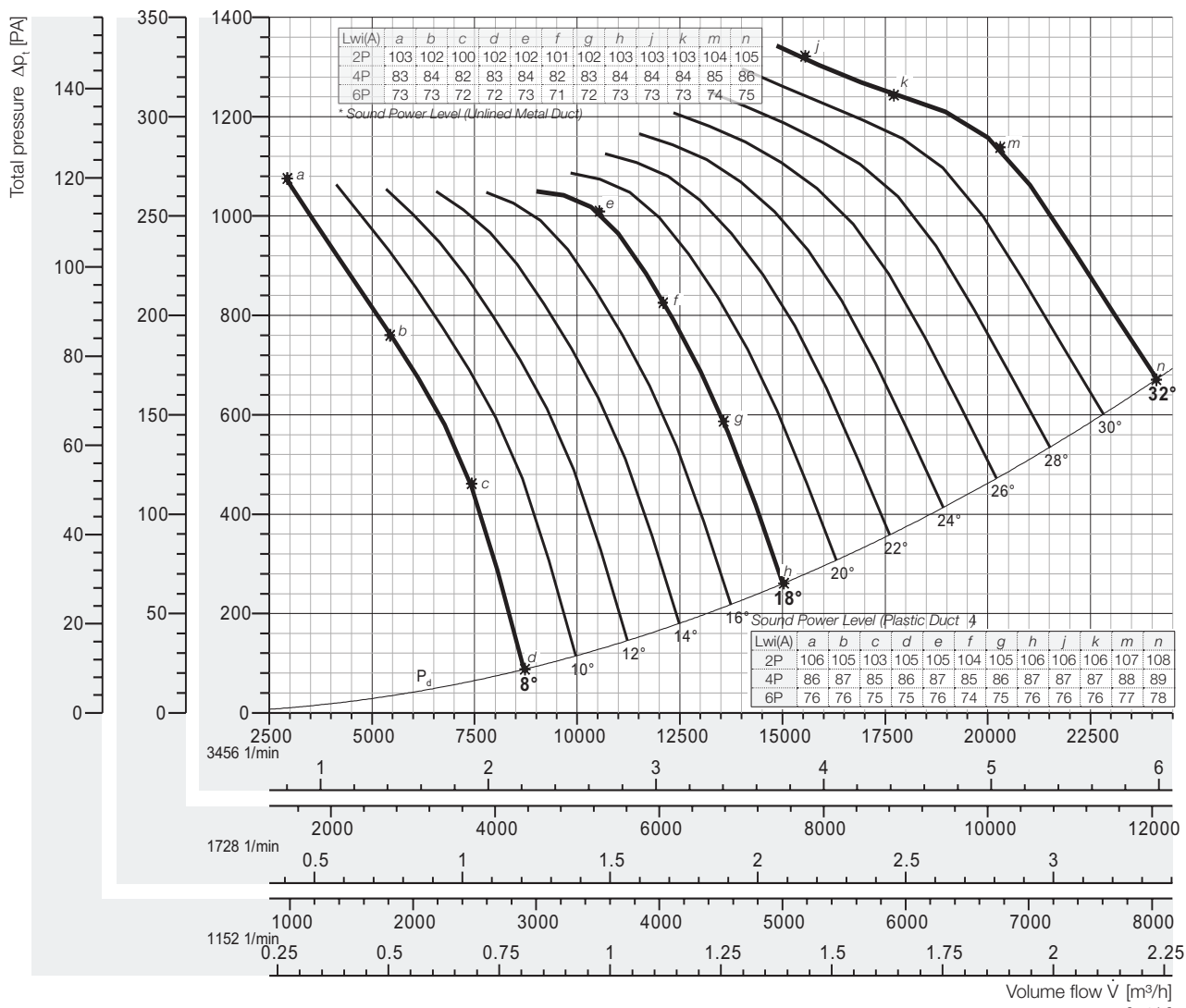
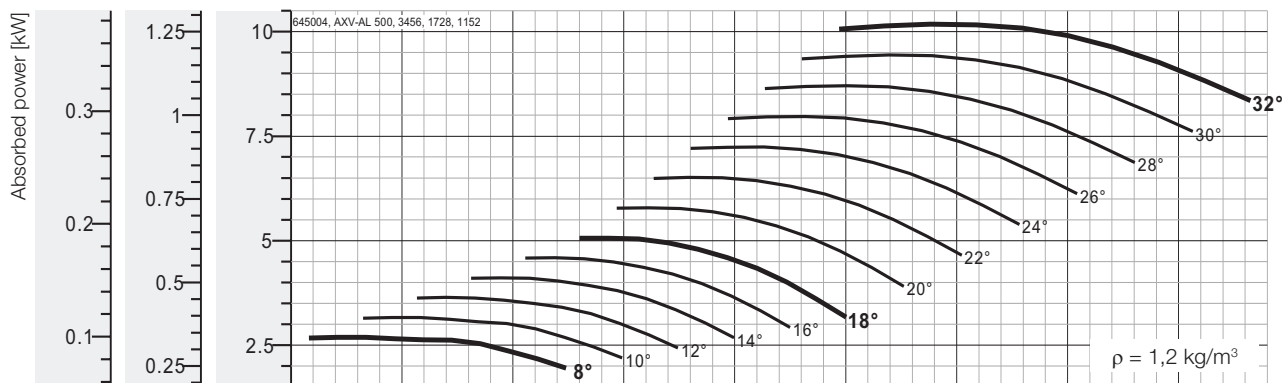

Speed [min<sup>-1</sup>]  
 3456 2-pol  
 1728 4-pol  
 1152 6-pol

## Peak absorbed power [kW]

\* Out of Range

n [min <sup>-1</sup> ]	Pitch angle [°]																
	8	10	12	14	16	18	20	22	24	26	28	30	32	34	36	38	40
1152 motor	0,099	0,117	0,135	0,152	0,170	0,187	0,214	0,241	0,268	0,295	0,322	0,350	0,377	-	-	-	-
	0,37												0,55				
1728 motor	0,336	0,395	0,454	0,514	0,573	0,633	0,723	0,814	0,905	0,997	1,09	1,18	1,27	-	-	-	-
	0,37	0,55			0,75			1,1				1,5					
3456 motor	2,69	3,16	3,64	4,11	4,59	5,06	5,79	6,51	7,24	7,97	8,71	9,44	10,2	-	-	-	-
	3	4		-*													

Fan test laboratory AMCA 210 Test Chamber. Performance certified is for installation type D - Ducted inlet, Ducted outlet. Performance ratings do not include the effects of appurtenances (accessories-belt cover, pulley & belt).

Dimensions + Accessories Page 191 - 194;  
 Sound power frequency spectrum L<sub>w</sub> Page 196 - 200.

The A-weighted sound ratings shown have been calculated per AMCA International Standard 301. Values shown are for inlet L<sub>wi</sub>A sound power levels for installation Type D: ducted inlet, ducted outlet. Ratings include the effects of duct end correction.

\* Sound power level with unlined metal duct were obtained from the test in the reverberant room. Data are not licensed by AMCA.



# Performance Curve

AXV 500-150-10, 60 Hz

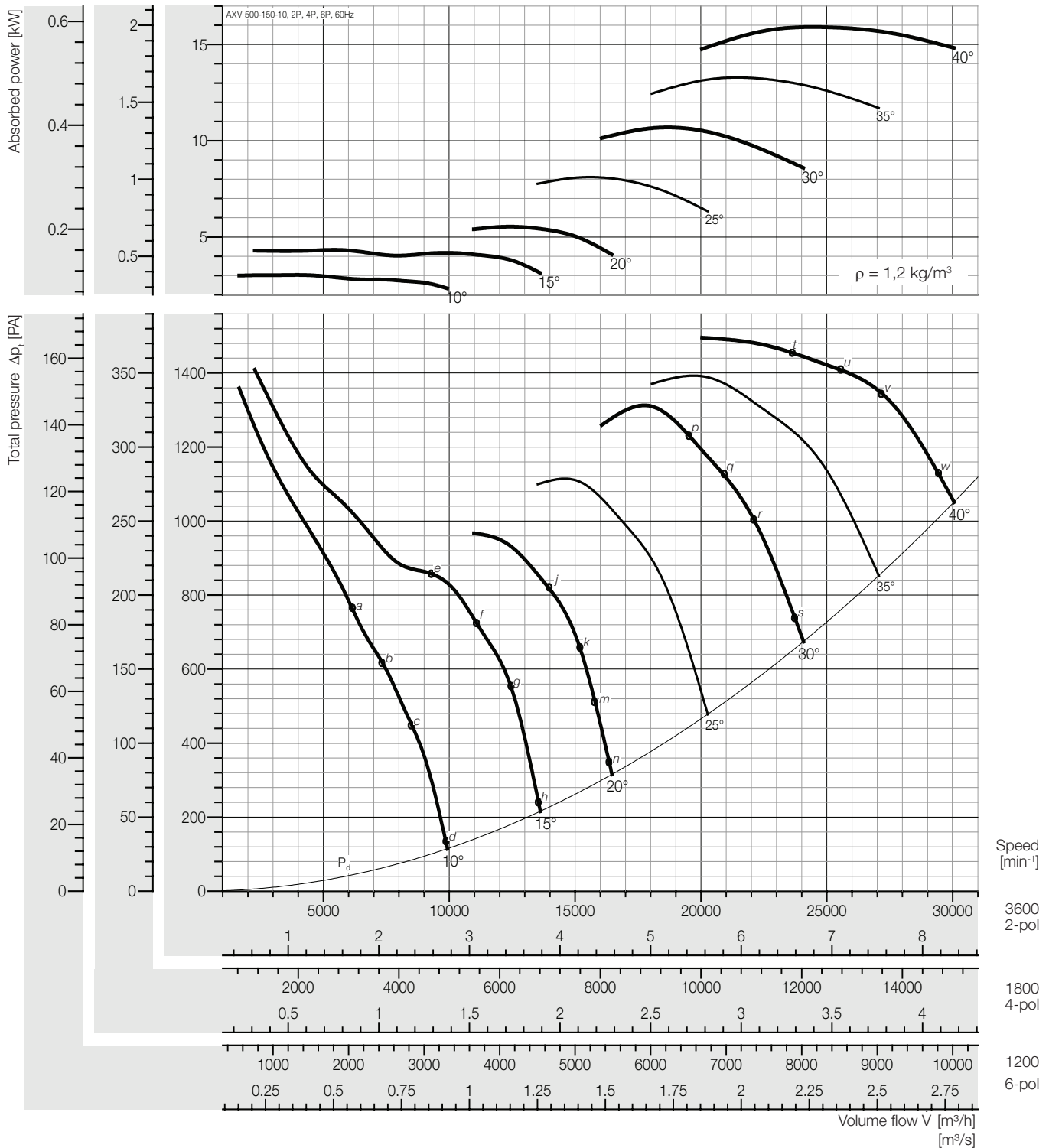

### Peak absorbed power [kW]

n [min <sup>-1</sup> ]	Pitch angle [°]						
	10	15	20	25	30	35	40
1200	0,112	0,155	0,205	0,300	0,396	0,492	0,589
Motor	0,18		0,25	0,37	0,55		0,75
1800	0,378	0,522	0,692	1,013	1,336	1,659	1,989
Motor	0,55		0,75	1,1	1,5	2,2	
3600	3,022	4,173	5,536	8,107	10,69	13,27	15,91
Motor	4,0	-					

### Sound power level, Lwi(A) [dB(A)]

Lwi(A)	a	b	c	d	e	f	g	h	j	k	m	n	p	q	r	s	t	u	v	w
2P	108	108	107	107	109	107	105	107	107	108	109	110	109	109	109	111	110	110	110	111
4P	90	91	91	89	92	90	87	90	89	90	91	92	91	91	93	92	93	92	93	93
6P	79	81	81	79	81	80	77	79	79	79	79	80	80	81	80	82	81	82	82	82

Plastic Duct

Lwi(A)	a	b	c	d	e	f	g	h	j	k	m	n	p	q	r	s	t	u	v	w
2P	106	106	105	105	107	105	103	105	105	106	107	108	107	107	107	109	108	108	108	109
4P	88	89	89	87	90	88	85	88	87	88	89	90	89	89	89	92	90	91	90	91
6P	77	79	79	77	79	78	75	77	77	77	77	78	78	79	78	80	79	80	80	80

\* Unlined Metal Duct

Fan test laboratory AMCA 210 Test Chamber. Performance certified is for installation type D - Ducted inlet, Ducted outlet. Performance ratings do not include the effects of appurtenances (accessories-belt cover, pulley & belt).

Dimensions + Accessories Page 191 - 194;  
Sound power frequency spectrum L<sub>w</sub>(A) Page 196 - 200.

The A-weighted sound ratings shown have been calculated per AMCA International Standard 301. Values shown are for inlet LwiA sound power levels for installation Type D: ducted inlet, ducted outlet. Ratings include the effects of duct end correction.

\* Sound power level with unlined metal duct were obtained from the test in the reverberant room. Data are not licensed by AMCA.



# Performance Curve

AXV 500-250-7, 2P, 4P, 6P, 60Hz

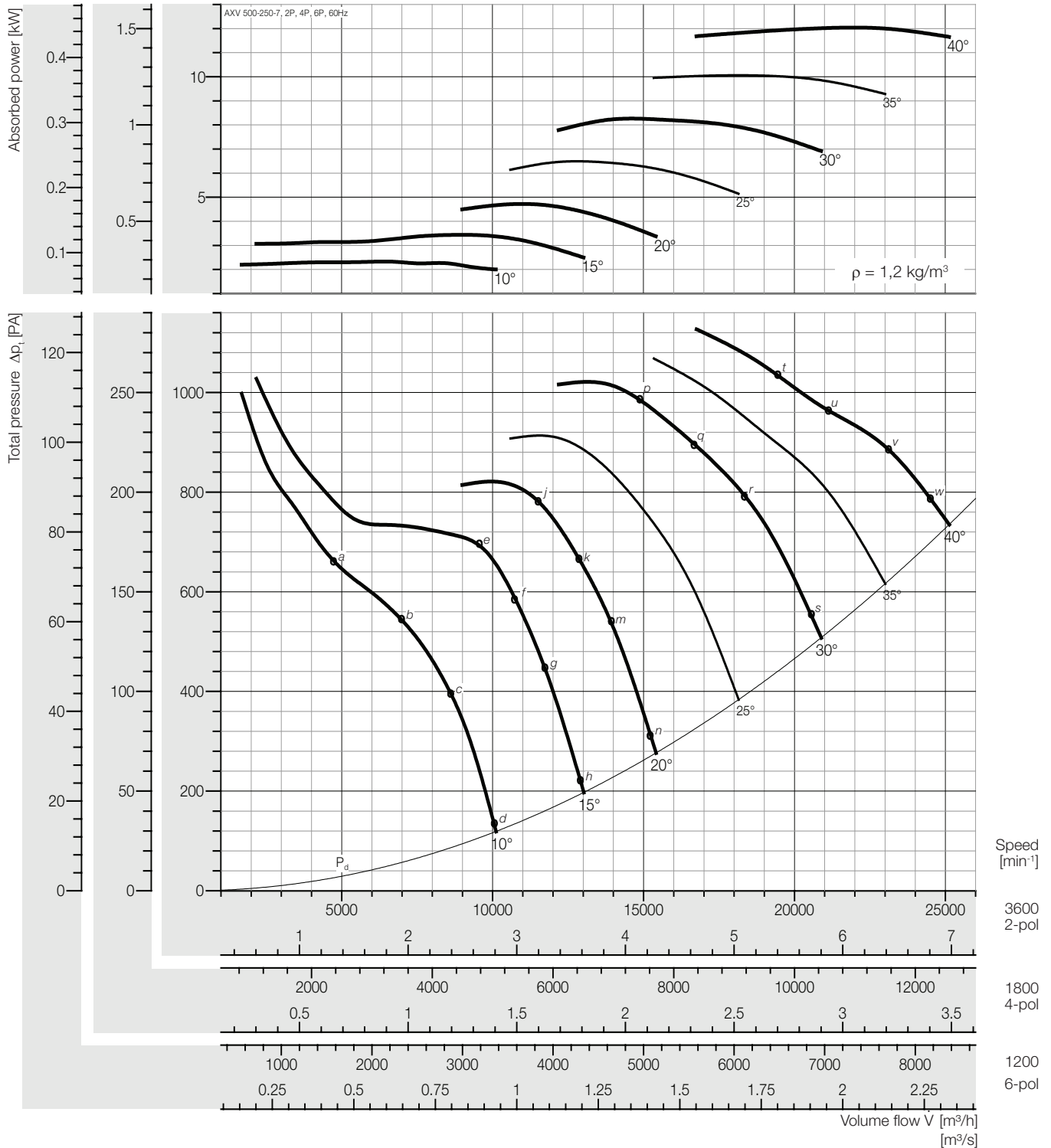

### Peak absorbed power [kW]

n [min <sup>-1</sup> ]	Pitch angle [°]						
	10	15	20	25	30	35	40
1200	0,086	0,127	0,175	0,240	0,306	0,373	0,446
Motor	0,18			0,25	0,37	0,55	0,75
1800	0,291	0,429	0,590	0,811	1,031	1,257	1,505
Motor	0,37	0,55	0,75	1,1		1,5	2,2
3600	2,330	3,432	4,719	6,485	8,250	10,06	12,04
Motor	3,0	4,0	5,5	7,5	11		-

### Sound power level, Lwi(A) [dB(A)]

Lwi(A)	a	b	c	d	e	f	g	h	j	k	m	n	p	q	r	s	t	u	v	w
2P	110	108	103	105	107	105	104	105	105	105	105	106	108	108	108	109	110	111	110	111
4P	91	91	86	88	90	87	86	88	87	87	87	88	89	89	89	91	92	92	92	92
6P	79	81	75	78	80	76	76	77	77	76	76	77	78	78	78	79	80	81	81	81

Plastic Duct

Lwi(A)	a	b	c	d	e	f	g	h	j	k	m	n	p	q	r	s	t	u	v	w
2P	108	106	101	103	105	103	102	103	103	103	103	104	106	106	106	107	108	109	108	109
4P	89	89	84	86	88	85	84	86	85	85	85	86	87	87	87	89	90	90	90	90
6P	77	79	73	76	78	74	74	75	75	74	74	75	76	76	76	77	78	79	79	79

\* Unlined Metal Duct

Fan test laboratory AMCA 210 Test Chamber. Performance certified is for installation type D - Ducted inlet, Ducted outlet. Performance ratings do not include the effects of appurtenances (accessories-belt cover, pulley & belt).

Dimensions + Accessories Page 191 - 194;  
Sound power frequency spectrum L<sub>w</sub>(f) Page 196 - 200.

The A-weighted sound ratings shown have been calculated per AMCA International Standard 301. Values shown are for inlet Lwi(A) sound power levels for installation Type D: ducted inlet, ducted outlet. Ratings include the effects of duct end correction.

\* Sound power level with unlined metal duct were obtained from the test in the reverberant room. Data are not licensed by AMCA.



# Performance Curve

AXV 560-110-3, 60 Hz

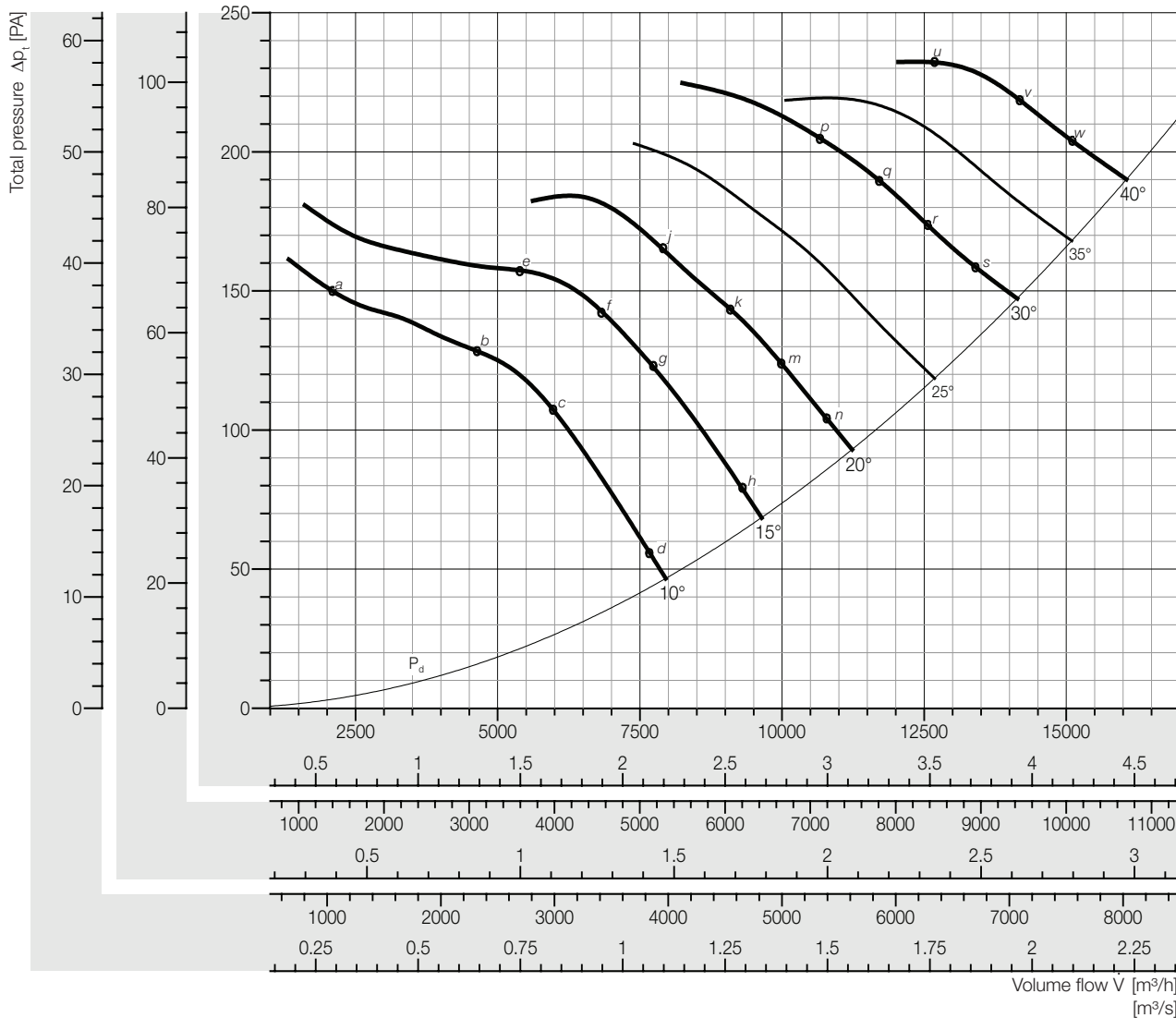
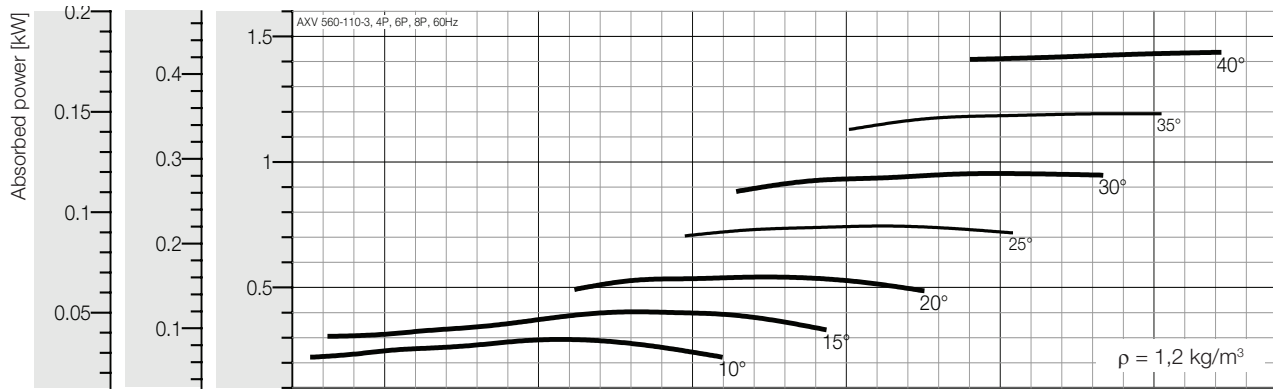

Speed [min<sup>-1</sup>]  
1800 4-pol  
1200 6-pol  
900 8-pol

### Peak absorbed power [kW]

n [min <sup>-1</sup> ]	Pitch angle [°]						
	10	15	20	25	30	35	40
900	0,036	0,050	0,068	0,093	0,119	0,149	0,180
Motor	0,18						
1200	0,086	0,119	0,161	0,221	0,283	0,353	0,426
Motor	0,18						
1800	0,291	0,402	0,542	0,744	0,954	1,192	1,437
Motor	0,37						

### Sound power level, Lwi(A) [dB(A)]

Lwi(A)	a	b	c	d	e	f	g	h	j	k	m	n	p	q	r	s	t	u	v	w
4P	91	92	92	91	91	89	89	90	90	90	90	90	90	90	90	94	-	92	92	93
6P	79	80	80	79	80	77	77	78	79	79	79	80	79	79	79	84	-	82	82	83
8P	71	73	72	71	72	70	69	70	72	72	71	72	72	72	76	-	75	75	76	

Plastic Duct

Lwi(A)	a	b	c	d	e	f	g	h	j	k	m	n	p	q	r	s	t	u	v	w
4P	89	90	90	89	89	87	87	88	88	88	88	88	88	88	88	92	-	90	90	91
6P	77	78	78	77	78	75	75	76	77	77	77	78	77	77	77	82	-	80	80	81
8P	69	71	70	69	70	68	67	68	70	70	69	70	70	70	74	-	73	73	74	

\* Unlined Metal Duct

Fan test laboratory AMCA 210 Test Chamber. Performance certified is for installation type D - Ducted inlet, Ducted outlet. Performance ratings do not include the effects of appurtenances (accessories-belt cover, pulley & belt).

Dimensions + Accessories Page 191 - 194;  
Sound power frequency spectrum L<sub>w(f)</sub> Page 196 - 200.

The A-weighted sound ratings shown have been calculated per AMCA International Standard 301. Values shown are for inlet LwiA sound power levels for installation Type D: ducted inlet, ducted outlet. Ratings include the effects of duct end correction.

\* Sound power level with unlined metal duct were obtained from the test in the reverberant room. Data are not licensed by AMCA.



# Performance Curve

AXV 560-110-6, 60 Hz

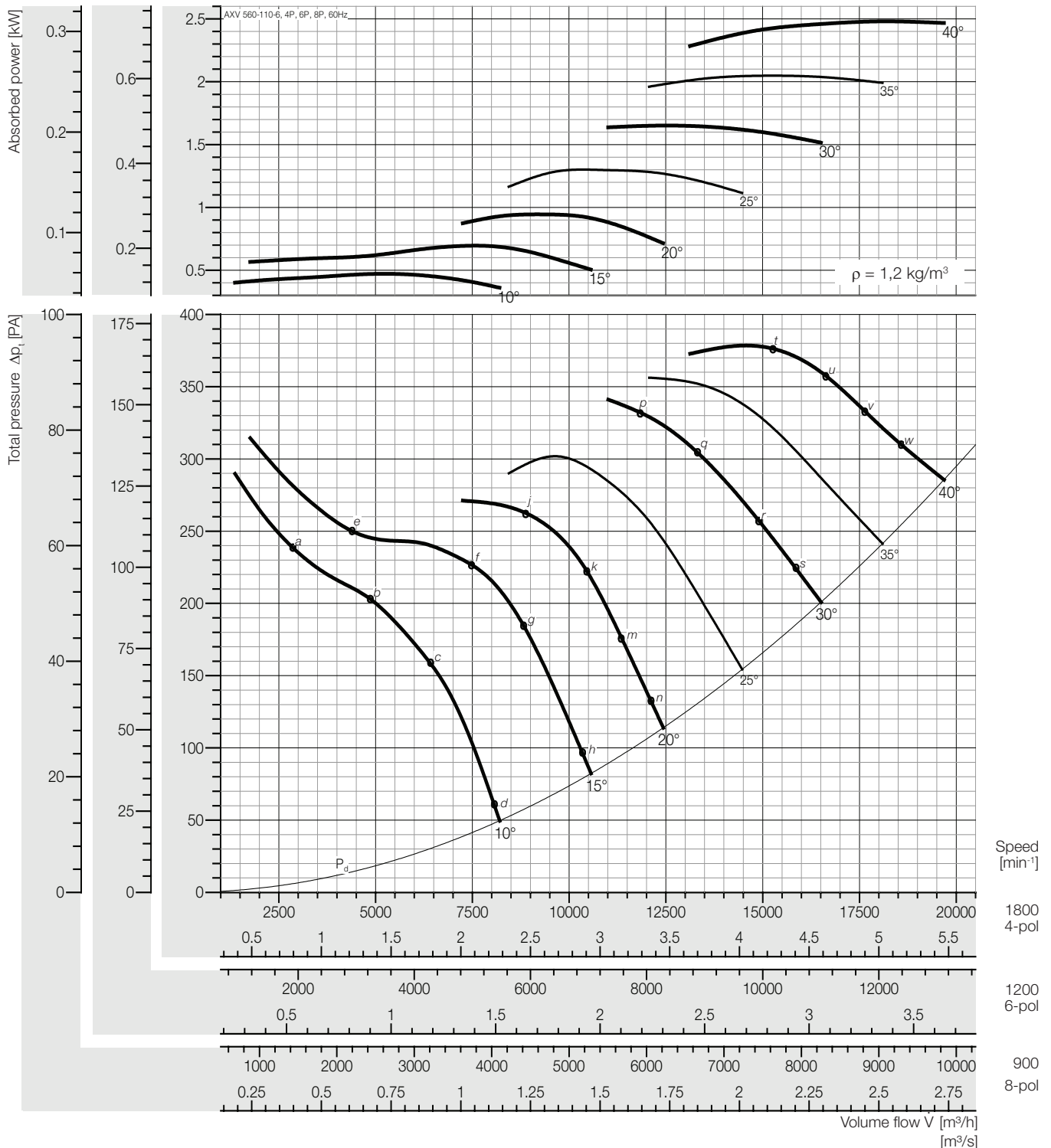

### Peak absorbed power [kW]

n [min <sup>-1</sup> ]	Pitch angle [°]						
	10	15	20	25	30	35	40
900	0,059	0,087	0,118	0,163	0,206	0,256	0,310
Motor	0,18				0,25	0,37	
1200	0,140	0,206	0,280	0,385	0,489	0,607	0,735
Motor	0,18	0,25	0,37	0,55		0,75	
1800	0,472	0,695	0,944	1,301	1,650	2,048	2,480
Motor	0,55	0,75	1,1	1,5	2,2		3,0

### Sound power level, Lwi(A) [dB(A)]

Lwi(A)	a	b	c	d	e	f	g	h	j	k	m	n	p	q	r	s	t	u	v	w
4P	98	97	95	94	97	94	91	91	94	93	93	94	93	93	93	94	95	95	95	95
6P	87	87	85	84	83	84	81	81	82	81	81	82	82	82	82	83	84	84	84	84
8P	80	80	78	77	76	76	73	73	75	74	74	75	75	75	76	77	77	77	77	77

Plastic Duct

Lwi(A)	a	b	c	d	e	f	g	h	j	k	m	n	p	q	r	s	t	u	v	w
4P	96	95	93	92	95	92	89	89	92	91	91	92	91	91	91	92	93	93	93	93
6P	85	85	83	82	81	82	79	79	80	79	79	80	80	80	80	81	82	82	82	82
8P	78	78	76	75	74	74	72	72	73	72	72	73	73	73	73	74	75	75	75	75

\* Unlined Metal Duct

Fan test laboratory AMCA 210 Test Chamber. Performance certified is for installation type D - Ducted inlet, Ducted outlet. Performance ratings do not include the effects of appurtenances (accessories-belt cover, pulley & belt).

Dimensions + Accessories Page 191 - 194;  
Sound power frequency spectrum L<sub>w</sub> Page 196 - 200.

The A-weighted sound ratings shown have been calculated per AMCA International Standard 301. Values shown are for inlet Lwi(A) sound power levels for installation Type D: ducted inlet, ducted outlet. Ratings include the effects of duct end correction.

\* Sound power level with unlined metal duct were obtained from the test in the reverberant room. Data are not licensed by AMCA.



# Performance Curve

AXV 560-150-5, 60 Hz

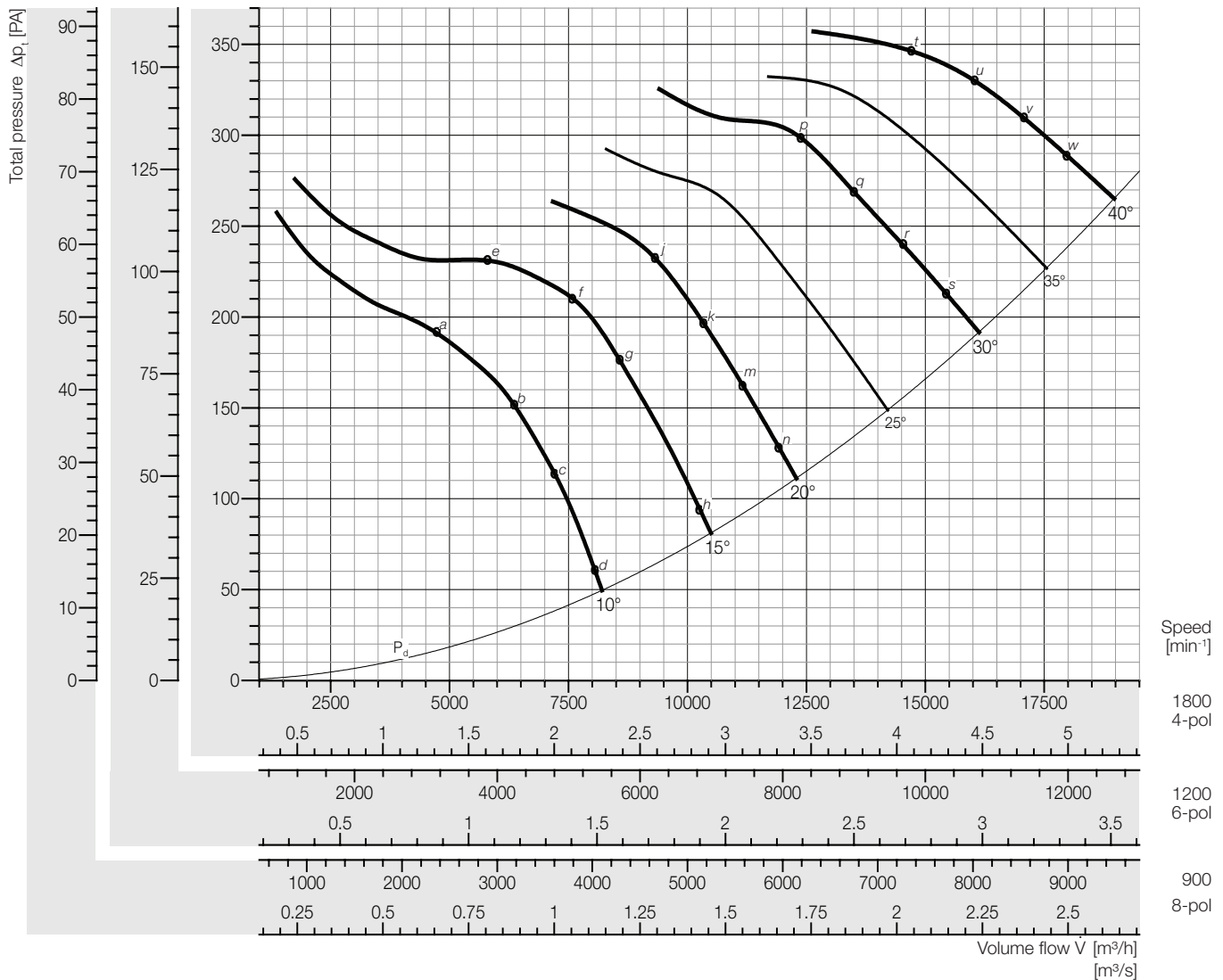
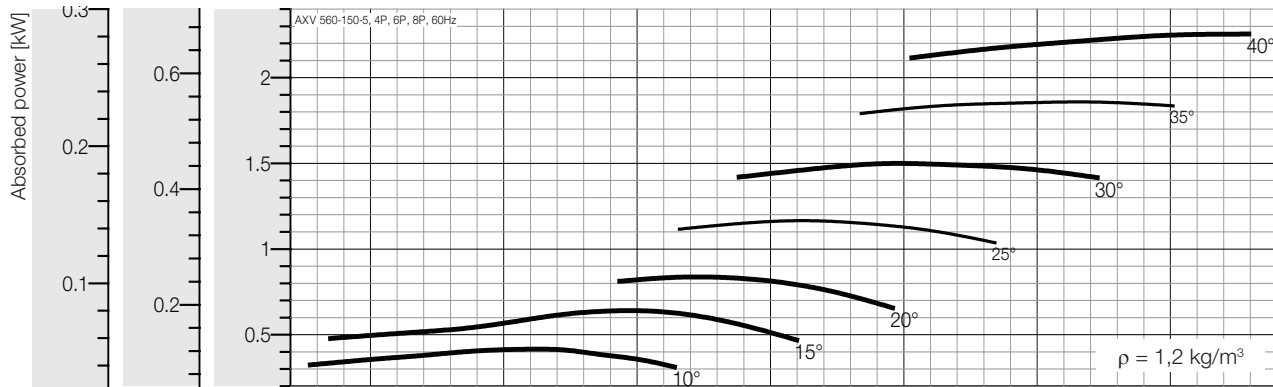

### Peak absorbed power [kW]

n [min <sup>-1</sup> ]	Pitch angle [°]						
	10	15	20	25	30	35	40
900	0,052	0,080	0,105	0,146	0,187	0,232	0,282
Motor	0,18				0,25		0,37
1200	0,123	0,190	0,248	0,345	0,444	0,550	0,668
Motor	0,18	0,25		0,37	0,55		0,75
1800	0,415	0,640	0,837	1,164	1,499	1,858	2,254
Motor	0,55	0,75	1,1	1,5		2,2	3,0

### Sound power level, Lwi(A) [dB(A)]

Lwi(A)	a	b	c	d	e	f	g	h	j	k	m	n	p	q	r	s	t	u	v	w
4P	97	94	93	93	95	91	93	95	90	90	90	90	92	92	92	92	94	95	95	95
6P	87	84	83	83	85	80	83	85	79	79	80	80	82	82	81	82	84	84	84	84
8P	80	77	76	76	77	73	75	78	71	72	72	72	74	74	74	74	76	76	76	77

Plastic Duct

Lwi(A)	a	b	c	d	e	f	g	h	j	k	m	n	p	q	r	s	t	u	v	w
4P	95	92	91	91	93	89	91	93	88	88	88	88	90	90	90	90	92	93	93	93
6P	85	82	81	81	83	78	81	83	77	77	78	78	80	80	79	80	82	82	82	82
8P	78	75	74	74	75	71	73	76	69	70	70	70	72	72	72	72	74	74	74	75

\* Unlined Metal Duct

Fan test laboratory AMCA 210 Test Chamber. Performance certified is for installation type D - Ducted inlet, Ducted outlet. Performance ratings do not include the effects of appurtenances (accessories-belt cover, pulley & belt).

Dimensions + Accessories Page 191 ~ 194;  
Sound power frequency spectrum L<sub>w</sub> Page 196 ~ 200.

The A-weighted sound ratings shown have been calculated per AMCA International Standard 301. Values shown are for inlet LwiA sound power levels for installation Type D: ducted inlet, ducted outlet. Ratings include the effects of duct end correction.

\* Sound power level with unlined metal duct were obtained from the test in the reverberant room. Data are not licensed by AMCA.



# Performance Curve

AXV 560-150-10, 60 Hz

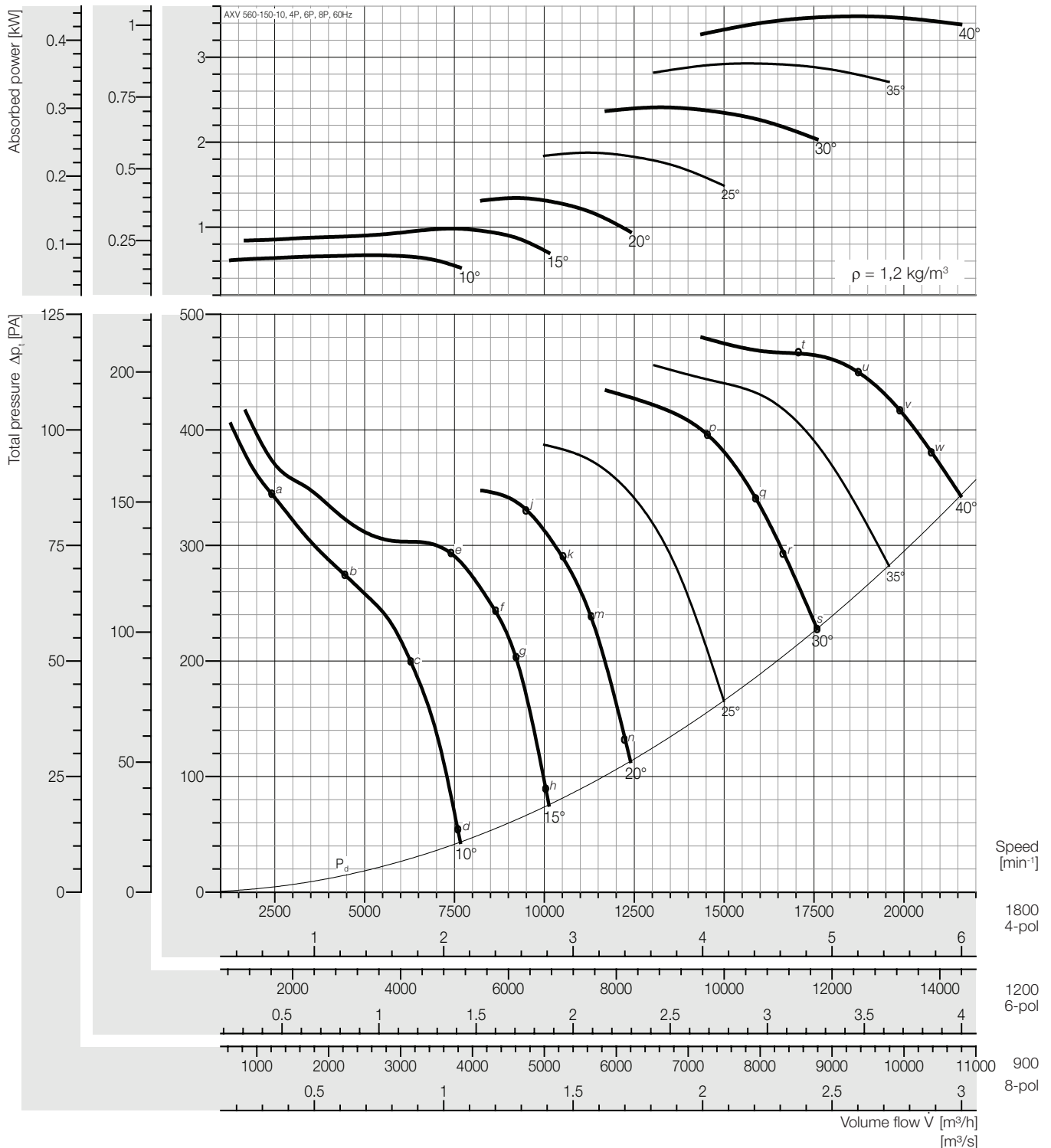

### Peak absorbed power [kW]

n [min <sup>-1</sup> ]	Pitch angle [°]						
	10	15	20	25	30	35	40
900	0,084	0,123	0,168	0,234	0,301	0,366	0,435
Motor	0,18			0,25	0,37		0,55
1200	0,198	0,291	0,398	0,556	0,714	0,867	1,031
Motor	0,25	0,37	0,55	0,75		1,1	
1800	0,668	0,983	1,343	1,876	2,408	2,925	3,479
Motor	0,75	1,1	1,5	2,2	3,0		4,0

### Sound power level, Lwi(A) [dB(A)]

Lwi(A)	a	b	c	d	e	f	g	h	j	k	m	n	p	q	r	s	t	u	v	w
4P	94	96	95	93	100	95	96	98	93	91	91	92	97	97	96	96	96	95	95	95
6P	84	85	85	83	89	85	86	88	83	81	81	82	88	88	86	86	86	85	85	85
8P	75	77	78	76	82	77	78	81	75	74	74	75	81	81	78	79	78	77	78	78

Plastic Duct

Lwi(A)	a	b	c	d	e	f	g	h	j	k	m	n	p	q	r	s	t	u	v	w
4P	92	94	93	91	98	93	94	96	91	89	89	90	95	95	94	94	94	93	93	93
6P	82	83	83	81	87	83	84	86	81	79	79	80	86	86	84	84	84	83	83	83
8P	73	75	76	74	80	75	76	79	73	72	72	73	79	79	76	77	76	75	76	76

\* Unlined Metal Duct

Fan test laboratory AMCA 210 Test Chamber. Performance certified is for installation type D - Ducted inlet, Ducted outlet. Performance ratings do not include the effects of appurtenances (accessories-belt cover, pulley & belt).

Dimensions + Accessories Page 191 - 194;  
Sound power frequency spectrum L<sub>w</sub> Page 196 - 200.

The A-weighted sound ratings shown have been calculated per AMCA International Standard 301. Values shown are for inlet Lwi(A) sound power levels for installation Type D: ducted inlet, ducted outlet. Ratings include the effects of duct end correction.

\* Sound power level with unlined metal duct were obtained from the test in the reverberant room. Data are not licensed by AMCA.





# Performance Curve

AXV 560-200-9, 60 Hz

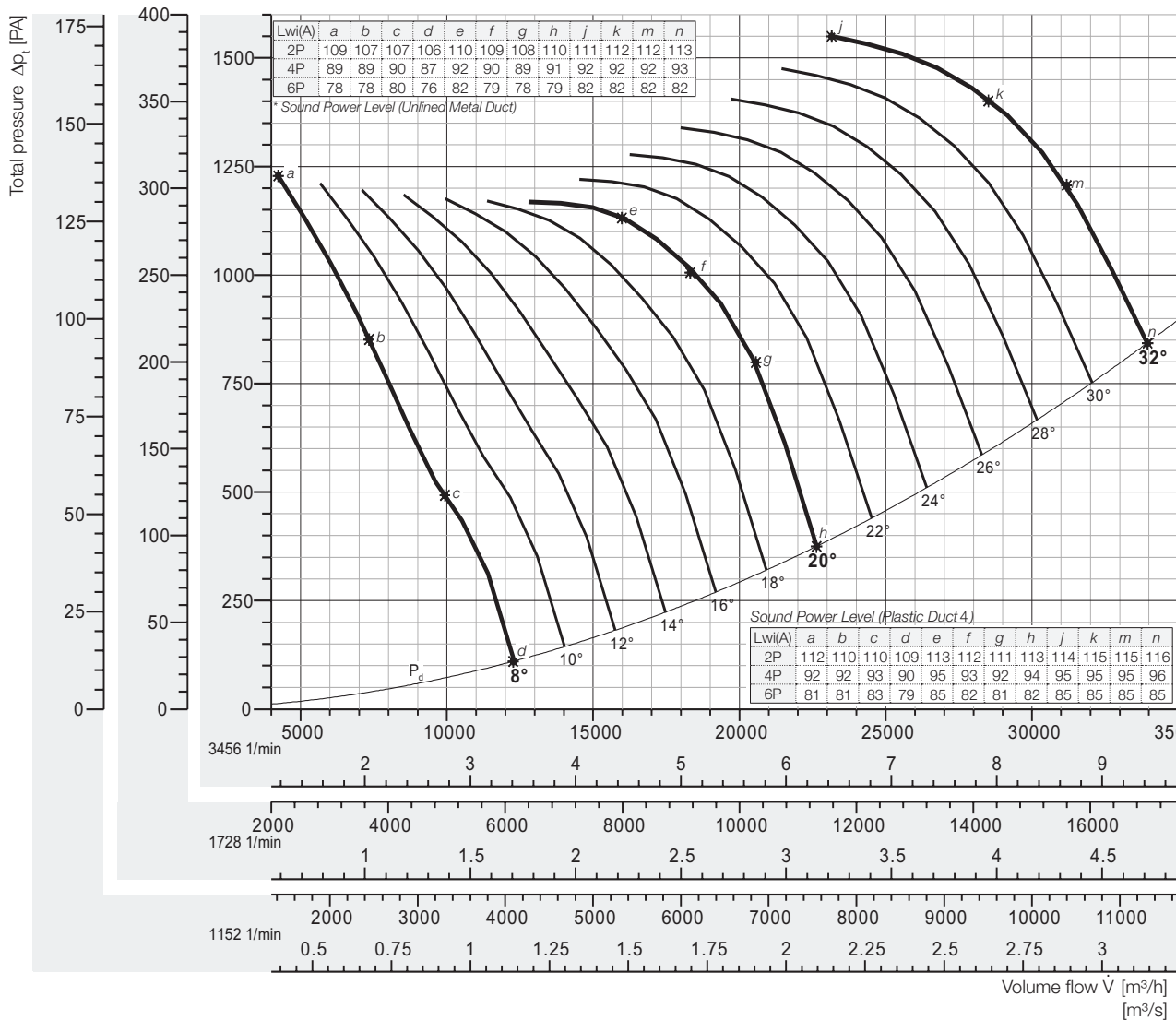
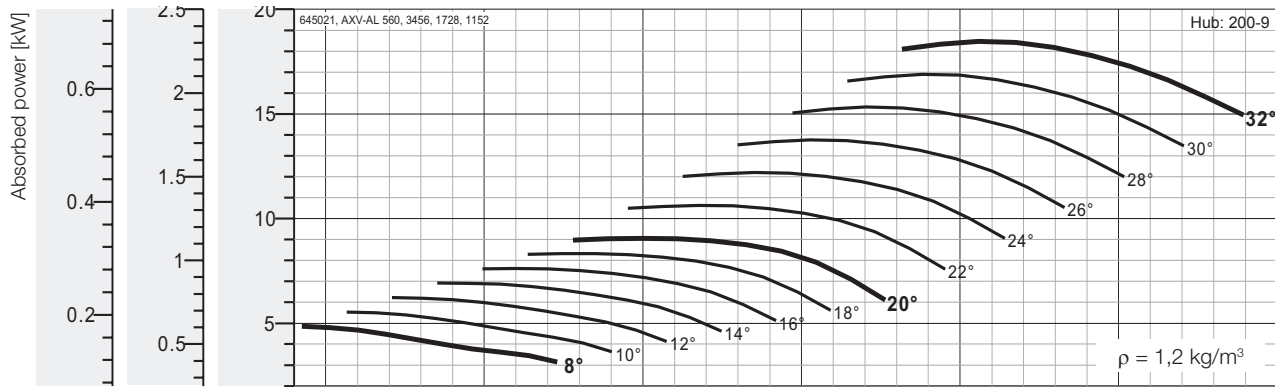

## Peak absorbed power [kW]

n [min <sup>-1</sup> ]	Pitch angle [°]																
	8	10	12	14	16	18	20	22	24	26	28	30	32	34	36	38	40
1152 motor	0,180	0,205	0,231	0,256	0,282	0,308	0,336	0,394	0,452	0,510	0,568	0,626	0,684	-	-	-	-
	0,37							0,55			0,75						
1728 motor	0,607	0,692	0,778	0,864	0,952	1,04	1,13	1,33	1,52	1,72	1,92	2,11	2,31	-	-	-	-
	0,75		1,1				1,5		2,2			3					
3456 motor	4,85	5,54	6,23	6,91	7,61	8,33	9,06	10,6	12,2	13,8	15,3	16,9	18,4	-	-	-	-
	5,5	7,5			11				15		18,5						

Fan test laboratory AMCA 210 Test Chamber. Performance certified is for installation type D - Ducted inlet, Ducted outlet. Performance ratings do not include the effects of appurtenances (accessories-belt cover, pulley & belt).

Dimensions + Accessories Page 191 - 194;  
Sound power frequency spectrum L<sub>w</sub> Page 196 - 200.

The A-weighted sound ratings shown have been calculated per AMCA International Standard 301. Values shown are for inlet Lw(A) sound power levels for installation Type D: ducted inlet, ducted outlet. Ratings include the effects of duct end correction.

\* Sound power level with unlined metal duct were obtained from the test in the reverberant room. Data are not licensed by AMCA.



# Performance Curve

AXV 560-250-7, 60 Hz

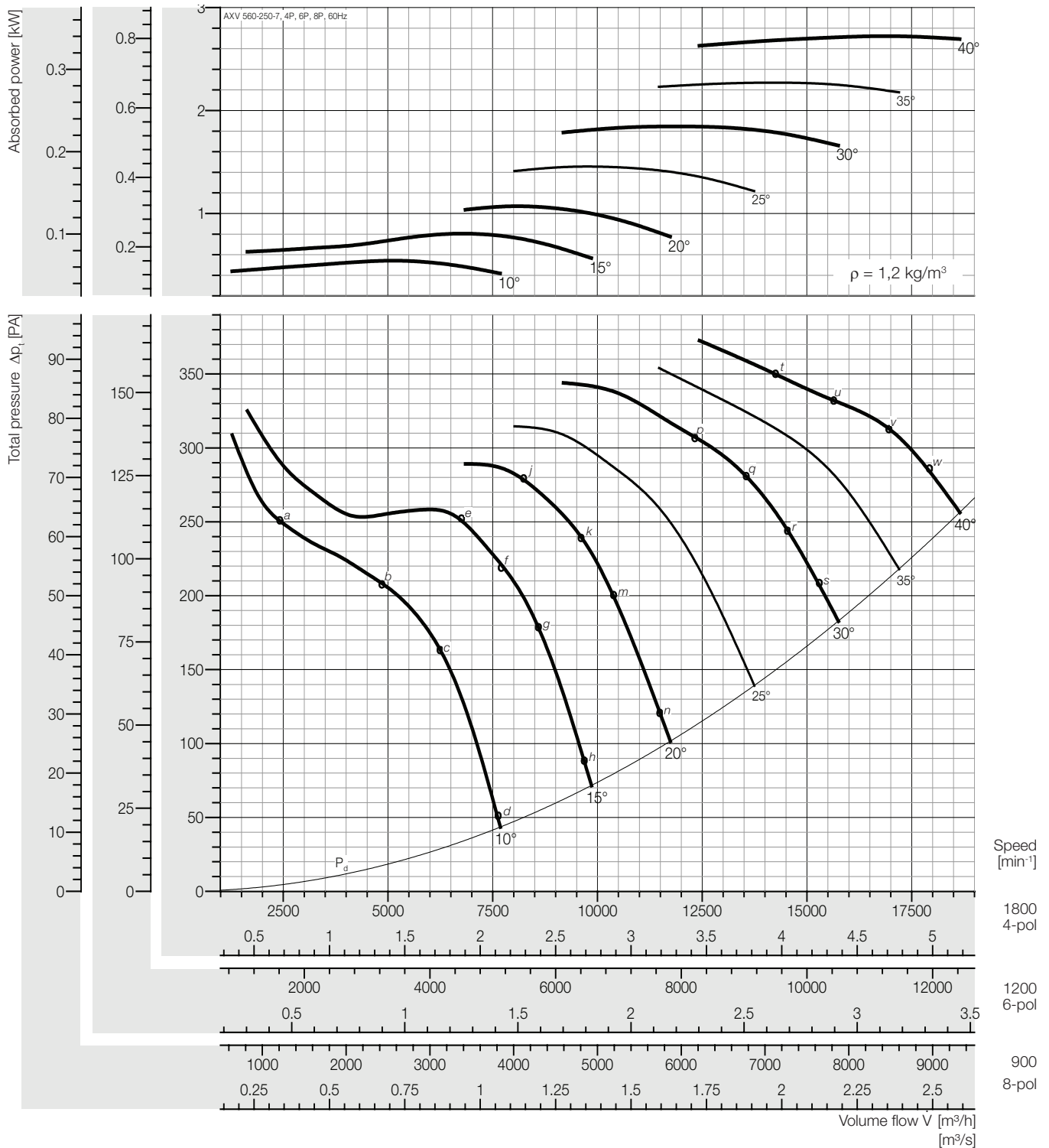

### Peak absorbed power [kW]

n [min <sup>-1</sup> ]	Pitch angle [°]						
	10	15	20	25	30	35	40
900	0,067	0,100	0,134	0,182	0,231	0,284	0,340
Motor	0,18			0,25		0,37	
1200	0,160	0,237	0,317	0,431	0,547	0,673	0,806
Motor	0,18	0,25	0,37	0,55		0,75	1,1
1800	0,540	0,801	1,070	1,455	1,845	2,270	2,722
Motor	0,55	1,1		1,5	2,2	3,0	

### Sound power level, Lwi(A) [dB(A)]

Lwi(A)	a	b	c	d	e	f	g	h	j	k	m	n	p	q	r	s	t	u	v	w
4P	94	96	93	95	94	91	91	91	92	93	94	91	95	95	96	97	95	96	96	97
6P	83	86	83	85	83	81	80	81	81	82	82	80	83	83	84	84	85	85	86	86
8P	75	78	76	78	76	73	73	73	74	74	74	73	76	76	77	77	78	78	78	79

Plastic Duct

Lwi(A)	a	b	c	d	e	f	g	h	j	k	m	n	p	q	r	s	t	u	v	w
4P	92	94	91	93	92	89	89	89	90	91	92	89	93	93	94	95	93	94	94	95
6P	81	84	81	83	81	79	78	79	79	80	80	78	81	81	82	82	83	83	84	84
8P	73	76	74	76	74	71	71	71	72	72	72	71	74	74	75	75	76	76	76	77

\* Unlined Metal Duct

Fan test laboratory AMCA 210 Test Chamber. Performance certified is for installation type D - Ducted inlet, Ducted outlet. Performance ratings do not include the effects of appurtenances (accessories-belt cover, pulley & belt).

Dimensions + Accessories Page 191 - 194;  
Sound power frequency spectrum L<sub>w</sub> Page 196 - 200.

The A-weighted sound ratings shown have been calculated per AMCA International Standard 301. Values shown are for inlet Lwi(A) sound power levels for installation Type D: ducted inlet, ducted outlet. Ratings include the effects of duct end correction.

\* Sound power level with unlined metal duct were obtained from the test in the reverberant room. Data are not licensed by AMCA.



# Performance Curve

AXV 560-250-14, 60 Hz

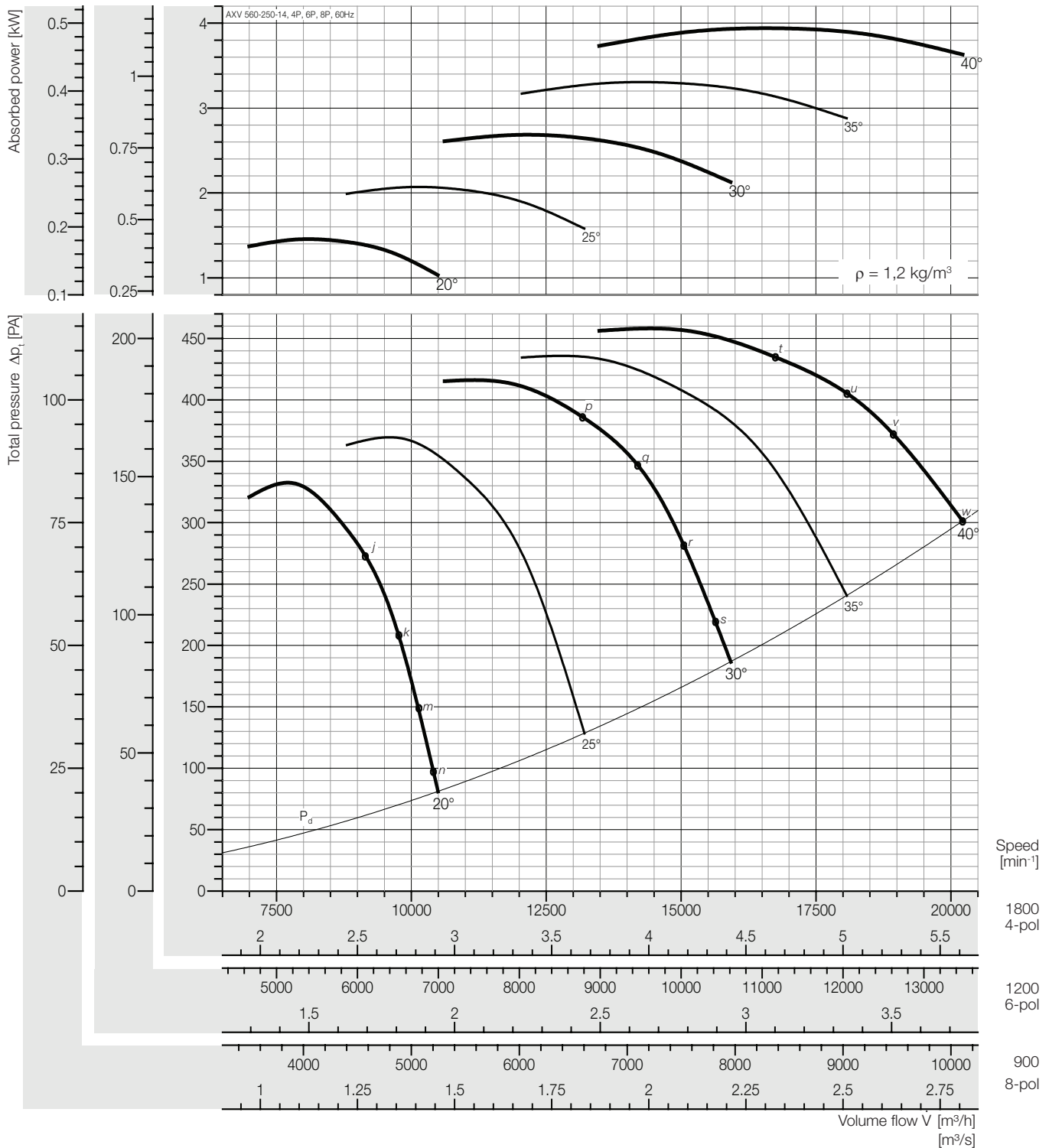

### Peak absorbed power [kW]

n [min <sup>-1</sup> ]	Pitch angle [°]						
	10	15	20	25	30	35	40
900	-	-	0,182	0,259	0,335	0,413	0,493
Motor			0,25	0,37		0,55	
1200	-	-	0,431	0,613	0,795	0,979	1,167
Motor			0,55	0,75	1,1		1,5
1800	-	-	1,456	2,070	2,683	3,305	3,940
Motor			1,5	2,2	3,0	4,0	

### Sound power level, Lwi(A) [dB(A)]

Lwi(A)	a	b	c	d	e	f	g	h	j	k	m	n	p	q	r	s	t	u	v	w
4P	-	-	-	-	-	-	-	-	92	93	94	91	95	95	96	97	95	96	96	97
6P	-	-	-	-	-	-	-	-	81	82	82	80	83	83	84	84	85	85	86	86
8P	-	-	-	-	-	-	-	-	74	74	74	73	76	76	77	77	78	78	78	79

Plastic Duct

Lwi(A)	a	b	c	d	e	f	g	h	j	k	m	n	p	q	r	s	t	u	v	w
4P	-	-	-	-	-	-	-	-	90	91	92	89	93	93	94	95	93	94	94	95
6P	-	-	-	-	-	-	-	-	79	80	80	78	81	81	82	82	83	83	84	84
8P	-	-	-	-	-	-	-	-	72	72	72	71	74	74	75	75	76	76	76	77

\* Unlined Metal Duct

Fan test laboratory AMCA 210 Test Chamber. Performance certified is for installation type D - Ducted inlet, Ducted outlet. Performance ratings do not include the effects of appurtenances (accessories-belt cover, pulley & belt).

Dimensions + Accessories Page 191 - 194;  
Sound power frequency spectrum L<sub>w</sub>(A) Page 196 - 200.

The A-weighted sound ratings shown have been calculated per AMCA International Standard 301. Values shown are for inlet LwiA sound power levels for installation Type D: ducted inlet, ducted outlet. Ratings include the effects of duct end correction.

\* Sound power level with unlined metal duct were obtained from the test in the reverberant room. Data are not licensed by AMCA.



# Performance Curve

AXV 630-110-3, 60 Hz

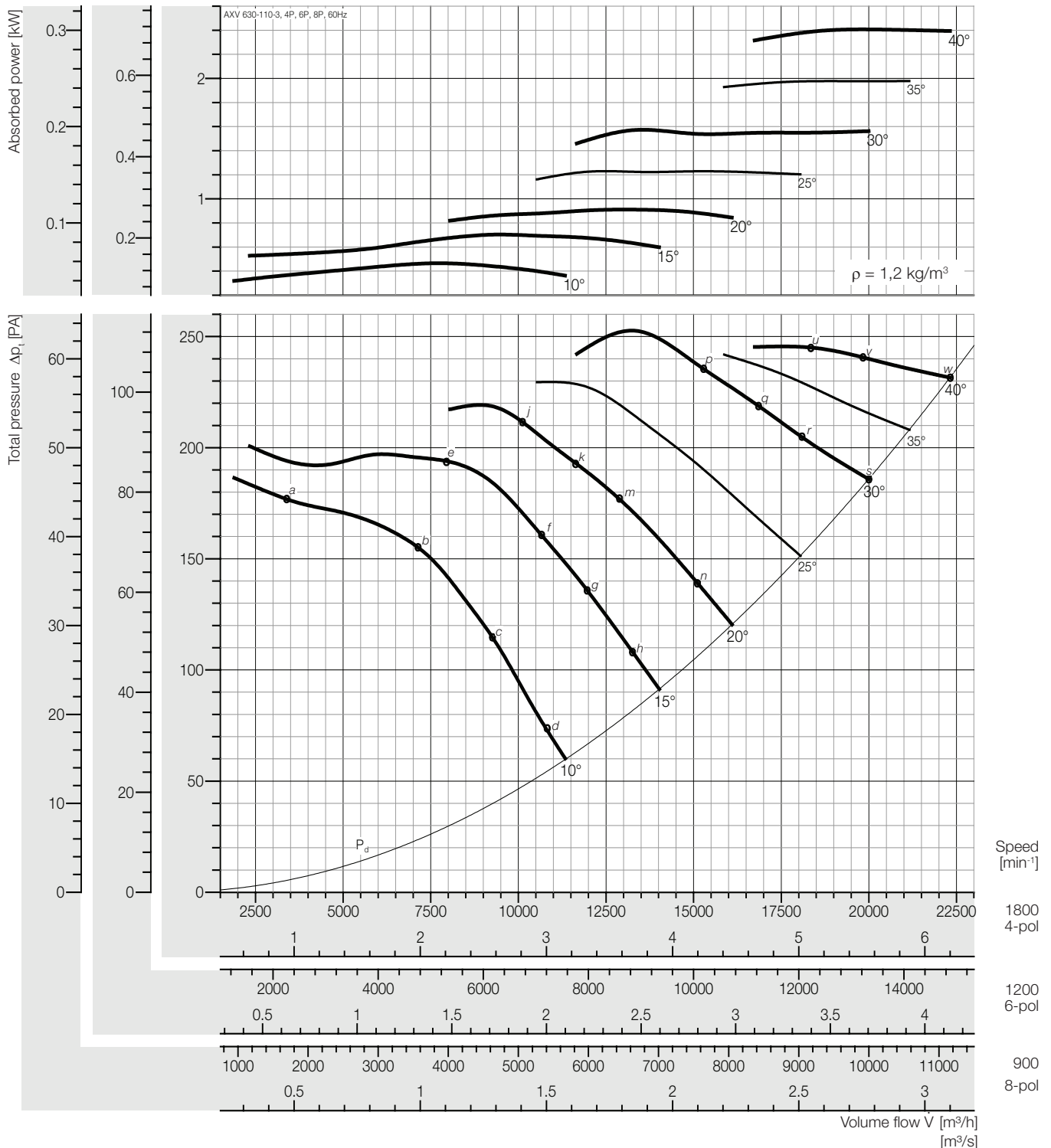

## Peak absorbed power [kW]

n [min <sup>-1</sup> ]	Pitch angle [°]						
	10	15	20	25	30	35	40
900	0,058	0,087	0,114	0,154	0,197	0,247	0,301
Motor	0,37						
1200	0,137	0,207	0,270	0,364	0,466	0,586	0,713
Motor	0,37						
1800	0,463	0,699	0,910	1,229	1,574	1,978	2,407
Motor	0,55	0,75	1,1	1,5	2,2	3,0	

## Sound power level, Lwi(A) [dB(A)]

Lwi(A)	a	b	c	d	e	f	g	h	j	k	m	n	p	q	r	s	t	u	v	w
4P	96	95	94	94	94	93	92	93	93	93	93	93	94	94	94	94	-	97	96	96
6P	86	84	83	84	83	82	81	81	82	82	83	83	83	83	83	83	-	86	85	86
8P	79	77	76	76	75	74	74	74	75	75	75	75	76	76	75	76	-	79	78	78

Plastic Duct

Lwi(A)	a	b	c	d	e	f	g	h	j	k	m	n	p	q	r	s	t	u	v	w
4P	94	93	92	92	92	91	90	91	91	91	91	91	92	92	92	92	-	95	94	94
6P	84	82	81	82	81	80	79	79	80	80	81	81	81	81	81	81	-	84	83	84
8P	77	75	74	74	73	72	72	72	73	73	73	73	74	74	73	74	-	77	76	76

\* Unlined Metal Duct

Fan test laboratory AMCA 210 Test Chamber. Performance certified is for installation type D - Ducted inlet, Ducted outlet. Performance ratings do not include the effects of appurtenances (accessories-belt cover, pulley & belt).

Dimensions + Accessories Page 191 - 194;  
Sound power frequency spectrum L<sub>w</sub>(f) Page 196 - 200.

The A-weighted sound ratings shown have been calculated per AMCA International Standard 301. Values shown are for inlet Lwi(A) sound power levels for installation Type D: ducted inlet, ducted outlet. Ratings include the effects of duct end correction.

\* Sound power level with unlined metal duct were obtained from the test in the reverberant room. Data are not licensed by AMCA.



# Performance Curve

AXV 630-110-6, 60 Hz

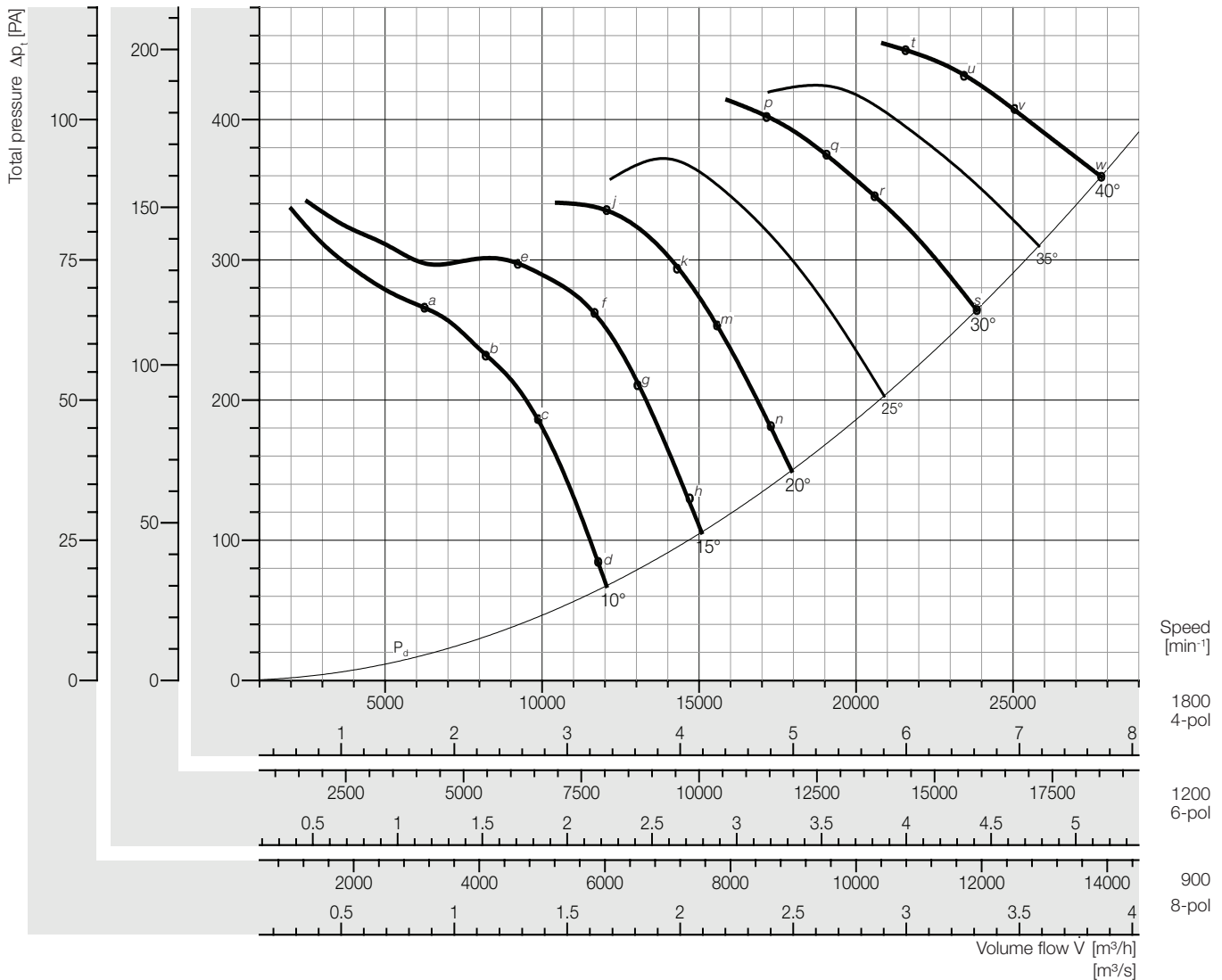
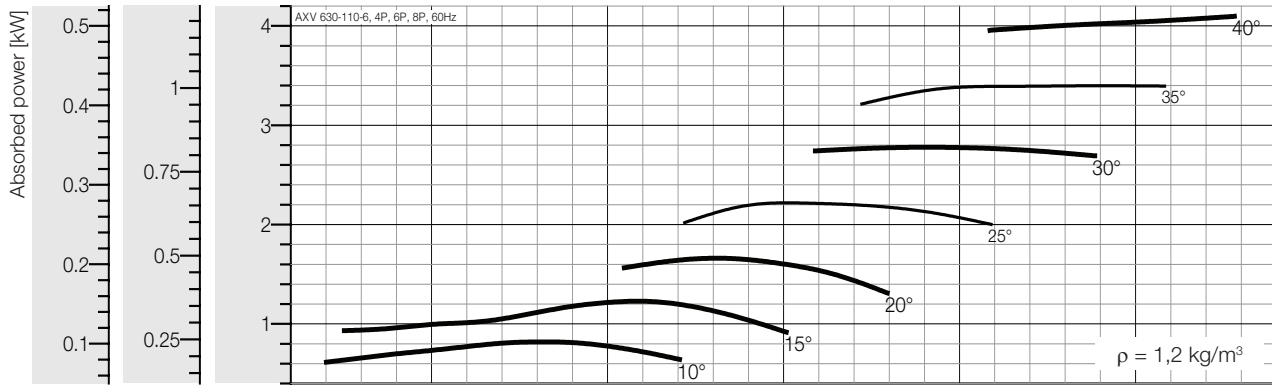

### Peak absorbed power [kW]

n [min <sup>-1</sup> ]	Pitch angle [°]						
	10	15	20	25	30	35	40
900	0,102	0,154	0,208	0,277	0,347	0,425	0,512
Motor	0,37					0,55	
1200	0,242	0,364	0,492	0,657	0,823	1,007	1,214
Motor	0,37		0,55	0,75	1,1	1,5	
1800	0,816	1,228	1,661	2,219	2,778	3,398	4,097
Motor	1,1	1,5	2,2	3,0	4,0		-

### Sound power level, Lwi(A) [dB(A)]

Lwi(A)	a	b	c	d	e	f	g	h	j	k	m	n	p	q	r	s	t	u	v	w
4P	97	98	95	94	100	97	97	97	98	97	97	96	99	98	98	99	98	98	98	98
6P	87	88	84	84	89	85	85	85	85	84	84	84	87	86	86	87	87	87	87	88
8P	79	80	77	76	81	78	78	77	78	77	77	77	80	79	79	79	80	80	80	80

Plastic Duct

Lwi(A)	a	b	c	d	e	f	g	h	j	k	m	n	p	q	r	s	t	u	v	w
4P	95	96	93	92	98	95	95	95	96	95	95	94	97	96	96	97	96	96	96	96
6P	85	86	82	82	87	83	83	83	83	82	82	82	85	84	84	85	85	85	85	86
8P	77	78	75	74	79	76	76	75	76	75	75	75	78	77	77	77	78	78	78	78

\* Unlined Metal Duct

Fan test laboratory AMCA 210 Test Chamber. Performance certified is for installation type D - Ducted inlet, Ducted outlet. Performance ratings do not include the effects of appurtenances (accessories-belt cover, pulley & belt).

Dimensions + Accessories Page 191 - 194;  
Sound power frequency spectrum L<sub>w</sub> Page 196 - 200.

The A-weighted sound ratings shown have been calculated per AMCA International Standard 301. Values shown are for inlet LwiA sound power levels for installation Type D: ducted inlet, ducted outlet. Ratings include the effects of duct end correction.

\* Sound power level with unlined metal duct were obtained from the test in the reverberant room. Data are not licensed by AMCA.



# Performance Curve

AXV 630-150-5, 60 Hz

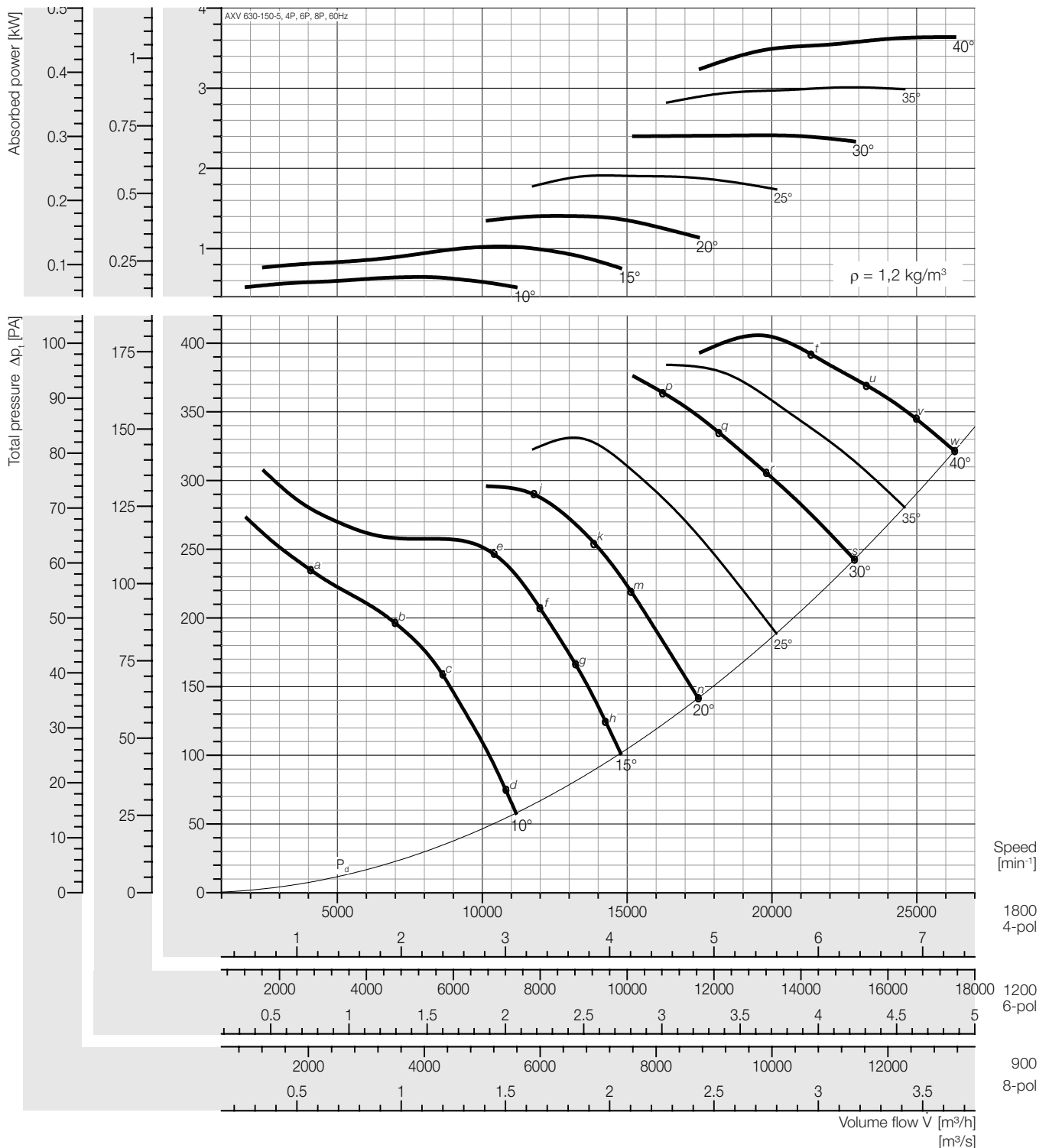

### Peak absorbed power [kW]

n [min <sup>-1</sup> ]	Pitch angle [°]						
	10	15	20	25	30	35	40
900	0,081	0,128	0,176	0,239	0,302	0,376	0,455
Motor	0,37					0,55	
1200	0,191	0,304	0,417	0,566	0,715	0,895	1,078
Motor	0,37		0,55	0,75	1,1		
1800	0,645	1,026	1,407	1,910	2,413	3,012	3,639
Motor	0,75	1,1	1,5	2,2	3,0	4,0	

### Sound power level, Lwi(A) [dB(A)]

Lwi(A)	a	b	c	d	e	f	g	h	j	k	m	n	p	q	r	s	t	u	v	w
4P	95	96	95	92	97	100	95	96	95	95	95	95	97	97	97	98	98	99	99	100
6P	84	86	85	83	87	90	85	87	85	85	85	85	86	86	87	88	88	89	89	90
8P	75	78	77	75	80	83	77	79	77	77	76	77	78	78	77	78	80	80	80	81

Plastic Duct

Lwi(A)	a	b	c	d	e	f	g	h	j	k	m	n	p	q	r	s	t	u	v	w
4P	93	94	93	90	95	98	93	94	93	93	93	93	95	95	95	96	96	97	97	98
6P	82	84	83	81	85	88	83	85	83	83	83	83	84	84	85	86	86	87	87	88
8P	73	76	75	73	78	81	75	77	75	75	74	75	76	76	75	76	78	78	78	79

\* Unlined Metal Duct

Fan test laboratory AMCA 210 Test Chamber. Performance certified is for installation type D - Ducted inlet, Ducted outlet. Performance ratings do not include the effects of appurtenances (accessories-belt cover, pulley & belt).

Dimensions + Accessories Page 191 - 194;  
Sound power frequency spectrum L<sub>w</sub>(A) Page 196 - 200.

The A-weighted sound ratings shown have been calculated per AMCA International Standard 301. Values shown are for inlet Lwi(A) sound power levels for installation Type D: ducted inlet, ducted outlet. Ratings include the effects of duct end correction.

\* Sound power level with unlined metal duct were obtained from the test in the reverberant room. Data are not licensed by AMCA.



# Performance Curve

AXV 630-150-10, 60 Hz

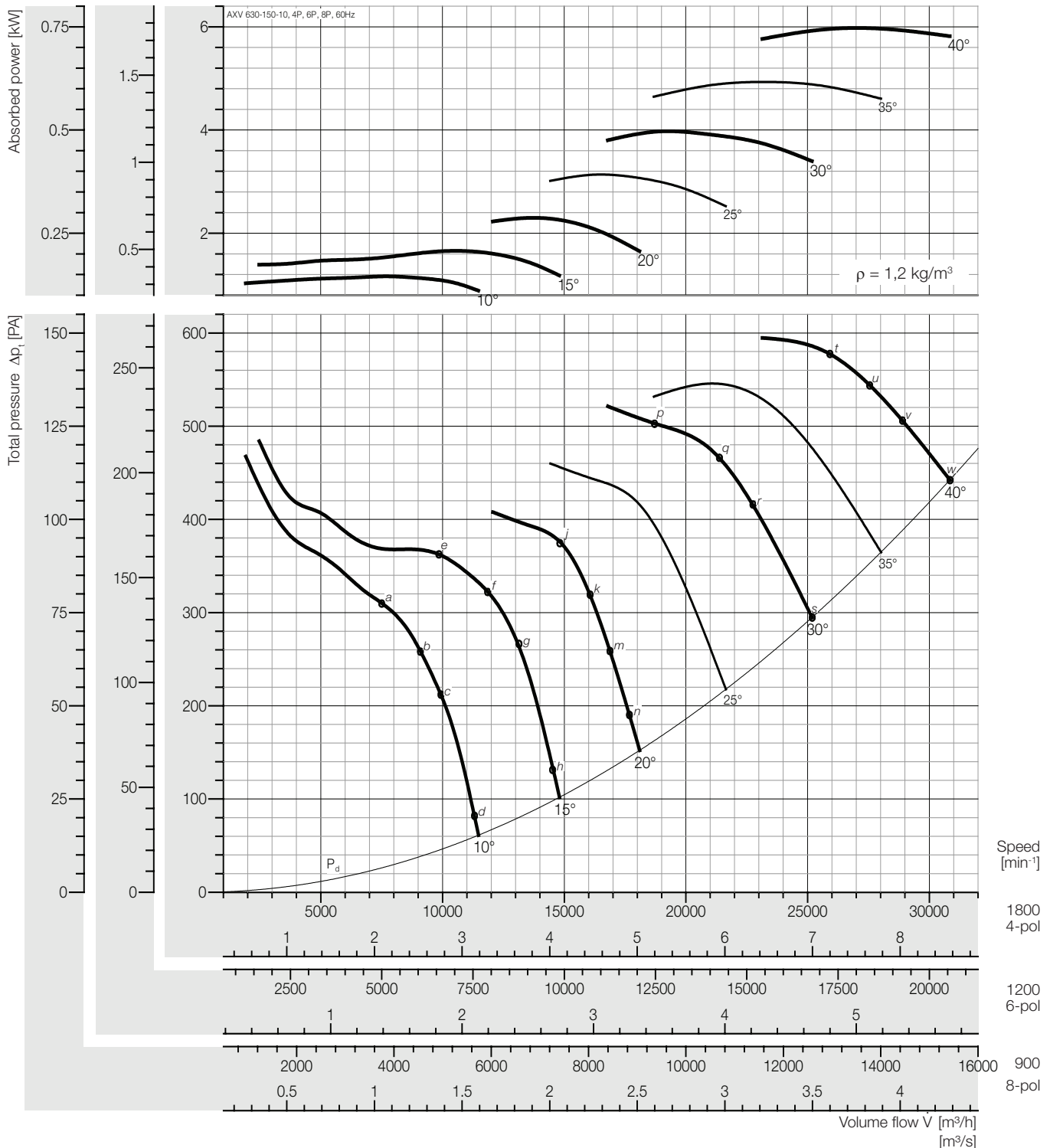

### Peak absorbed power [kW]

n [min <sup>-1</sup> ]	Pitch angle [°]						
	10	15	20	25	30	35	40
900	0,145	0,207	0,287	0,400	0,537	0,642	0,747
Motor	0,37			0,55		0,75	
1200	0,344	0,492	0,680	0,948	1,273	1,521	1,770
Motor	0,37	0,55	0,75	1,1	1,5	2,2	
1800	1,161	1,659	2,296	3,201	4,295	5,135	5,975
Motor	1,5	2,2	3,0	4,0	-		

### Sound power level, Lwi(A) [dB(A)]

Lwi(A)	a	b	c	d	e	f	g	h	j	k	m	n	p	q	r	s	t	u	v	w
4P	99	98	96	96	100	98	95	96	97	96	96	98	98	99	99	99	98	98	99	99
6P	89	88	86	86	90	87	86	87	86	86	87	88	87	88	88	89	88	88	88	89
8P	81	81	79	79	82	80	78	79	79	79	79	80	80	80	80	81	81	80	81	81

Plastic Duct

Lwi(A)	a	b	c	d	e	f	g	h	j	k	m	n	p	q	r	s	t	u	v	w
4P	97	96	94	94	98	96	93	94	95	94	94	96	96	97	97	97	96	96	97	97
6P	87	86	84	84	88	85	84	85	84	84	85	86	85	86	86	87	86	86	86	87
8P	79	79	77	77	80	78	76	77	77	77	77	78	78	78	78	79	79	78	79	79

\* Unlined Metal Duct

Fan test laboratory AMCA 210 Test Chamber. Performance certified is for installation type D - Ducted inlet, Ducted outlet. Performance ratings do not include the effects of appurtenances (accessories-belt cover, pulley & belt).

Dimensions + Accessories Page 191 - 194;  
Sound power frequency spectrum L<sub>wref</sub> Page 196 - 200.

The A-weighted sound ratings shown have been calculated per AMCA International Standard 301. Values shown are for inlet LwiA sound power levels for installation Type D: ducted inlet, ducted outlet. Ratings include the effects of duct end correction.

\* Sound power level with unlined metal duct were obtained from the test in the reverberant room. Data are not licensed by AMCA.



# Performance Curve

AXV 630-200-9, 60 Hz

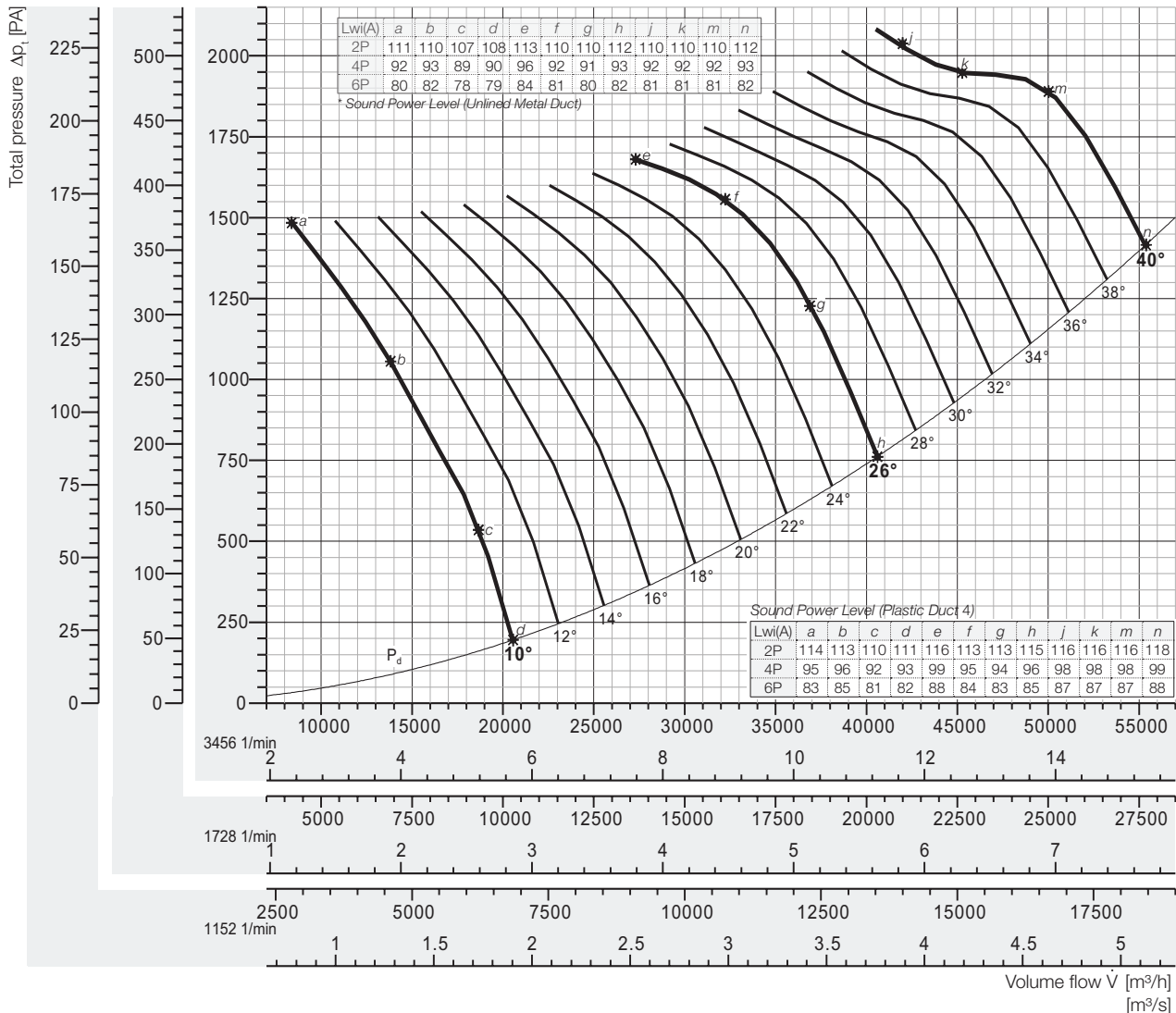
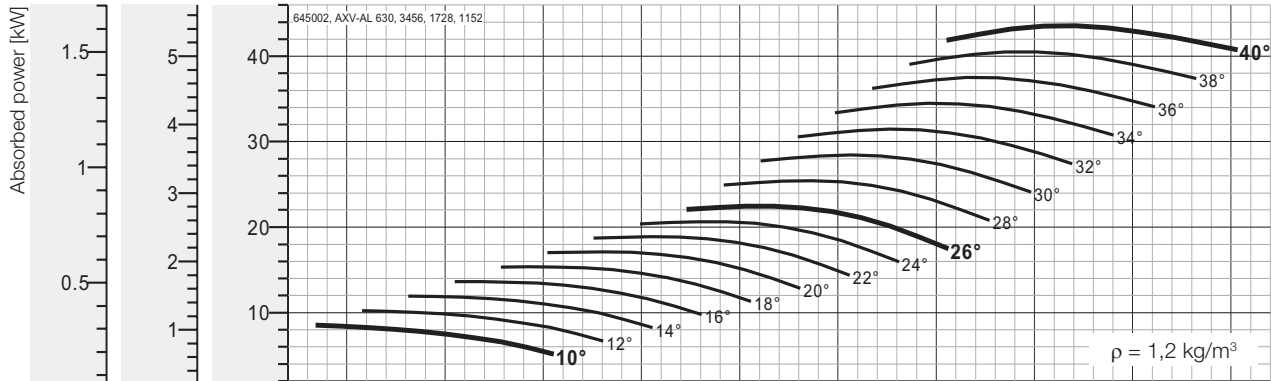

Speed [min<sup>-1</sup>]  
 3456 2-pol  
 1728 4-pol  
 1152 6-pol

## Peak absorbed power [kW]

\* Out of Range

n [min <sup>-1</sup> ]	Pitch angle [°]																
	8	10	12	14	16	18	20	22	24	26	28	30	32	34	36	38	40
1152 motor	-	0,316	0,379	0,442	0,505	0,568	0,624	0,699	0,765	0,831	0,942	1,05	1,17	1,28	1,39	1,50	1,63
		0,37	0,55			0,75			1,1				1,5				2,2
1728 motor	-	1,07	1,28	1,49	1,70	1,92	2,14	2,36	2,58	2,80	3,18	3,56	3,93	4,31	4,69	5,06	5,44
		1,1	1,5		2,2			3			4			5,5			
3456 motor	-	8,54	10,2	11,9	13,6	15,3	17,1	18,9	20,7	22,4	25,4	28,5	31,5	34,5	37,5	40,5	43,6
		11		15		18,5		-*									

Fan test laboratory AMCA 210 Test Chamber. Performance certified is for installation type D - Ducted inlet, Ducted outlet. Performance ratings do not include the effects of appurtenances (accessories-belt cover, pulley & belt).

Dimensions + Accessories Page 191 - 194;  
 Sound power frequency spectrum L<sub>w</sub> Page 196 - 200.

The A-weighted sound ratings shown have been calculated per AMCA International Standard 301. Values shown are for inlet L<sub>wi</sub>A sound power levels for installation Type D: ducted inlet, ducted outlet. Ratings include the effects of duct end correction.

\* Sound power level with unlined metal duct were obtained from the test in the reverberant room. Data are not licensed by AMCA.





# Performance Curve

AXV 630-250-7, 60 Hz

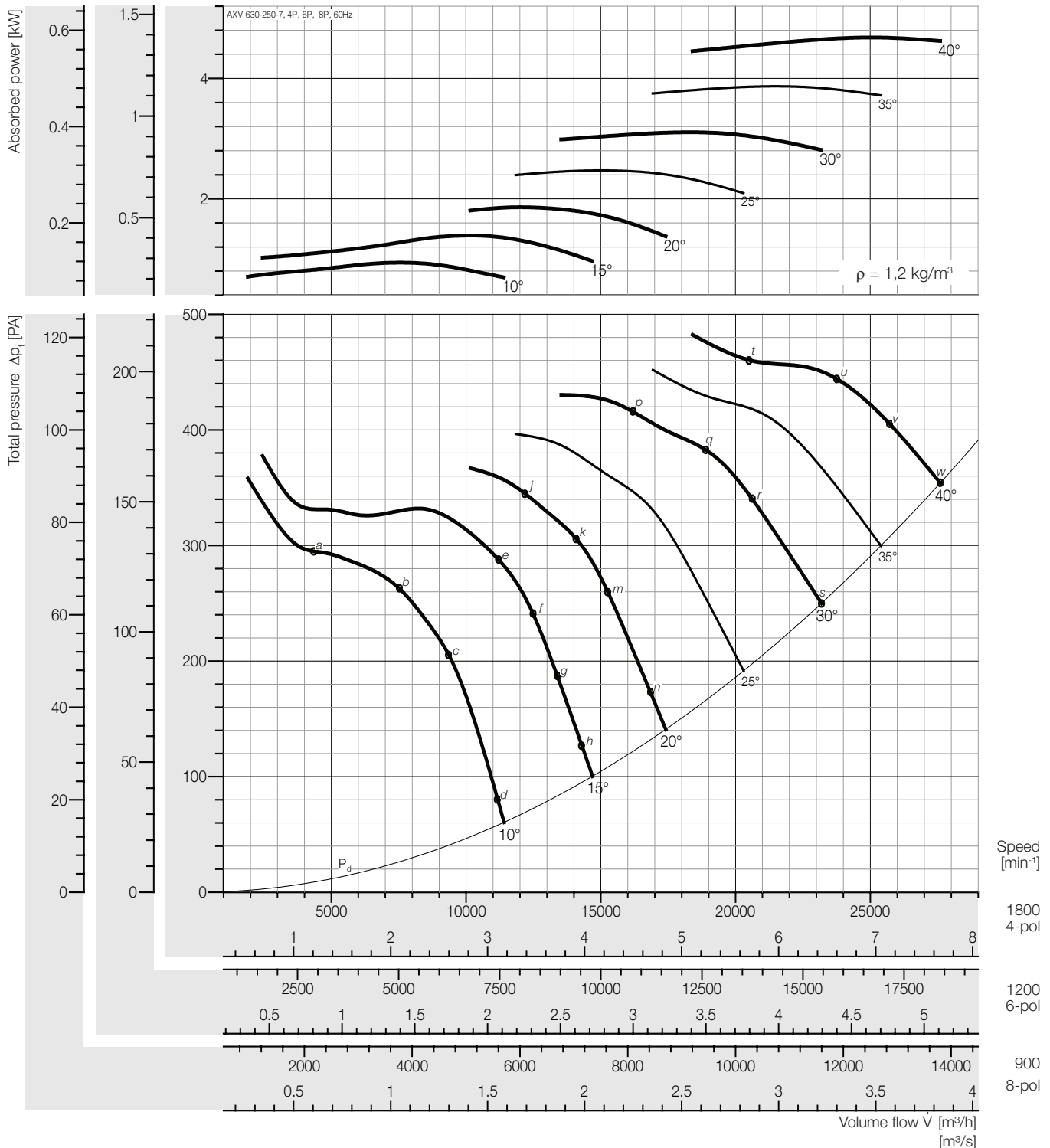

### Peak absorbed power [kW]

n [min <sup>-1</sup> ]	Pitch angle [°]							
	10	15	20	25	30	35	40	
900	0,117	0,173	0,233	0,309	0,388	0,484	0,585	
Motor	0,37						0,55	0,75
1200	0,278	0,411	0,550	0,732	0,920	1,146	1,386	
Motor	0,37	0,55	0,75		1,1	1,5		
1800	0,939	1,387	1,860	2,471	3,104	3,869	4,678	
Motor	1,1	1,5	2,2	3,0	4,0	5,5		

### Sound power level, Lwi(A) [dB(A)]

Lwi(A)	a	b	c	d	e	f	g	h	j	k	m	n	p	q	r	s	t	u	v	w
4P	98	98	96	96	95	95	95	95	95	95	96	96	98	97	97	98	99	99	99	100
6P	88	89	86	86	84	84	85	85	84	85	85	86	86	86	86	87	89	88	88	89
8P	82	83	80	79	77	77	77	76	77	78	78	79	79	79	79	79	82	81	81	82

Plastic Duct

Lwi(A)	a	b	c	d	e	f	g	h	j	k	m	n	p	q	r	s	t	u	v	w
4P	96	96	94	94	93	93	93	93	93	93	94	94	96	95	95	96	97	97	97	98
6P	86	87	84	84	82	82	83	83	82	83	83	84	84	84	84	85	87	86	86	87
8P	80	81	78	77	75	75	75	74	75	76	76	77	77	77	77	77	80	79	79	80

\* Unlined Metal Duct

Fan test laboratory AMCA 210 Test Chamber. Performance certified is for installation type D - Ducted inlet, Ducted outlet. Performance ratings do not include the effects of appurtenances (accessories-belt cover, pulley & belt).

Dimensions + Accessories Page 191 - 194;  
Sound power frequency spectrum L<sub>w</sub>(A) Page 196 - 200.

The A-weighted sound ratings shown have been calculated per AMCA International Standard 301. Values shown are for inlet LwiA sound power levels for installation Type D: ducted inlet, ducted outlet. Ratings include the effects of duct end correction.

\* Sound power level with unlined metal duct were obtained from the test in the reverberant room. Data are not licensed by AMCA.



# Performance Curve

AXV 630-250-14, 60 Hz

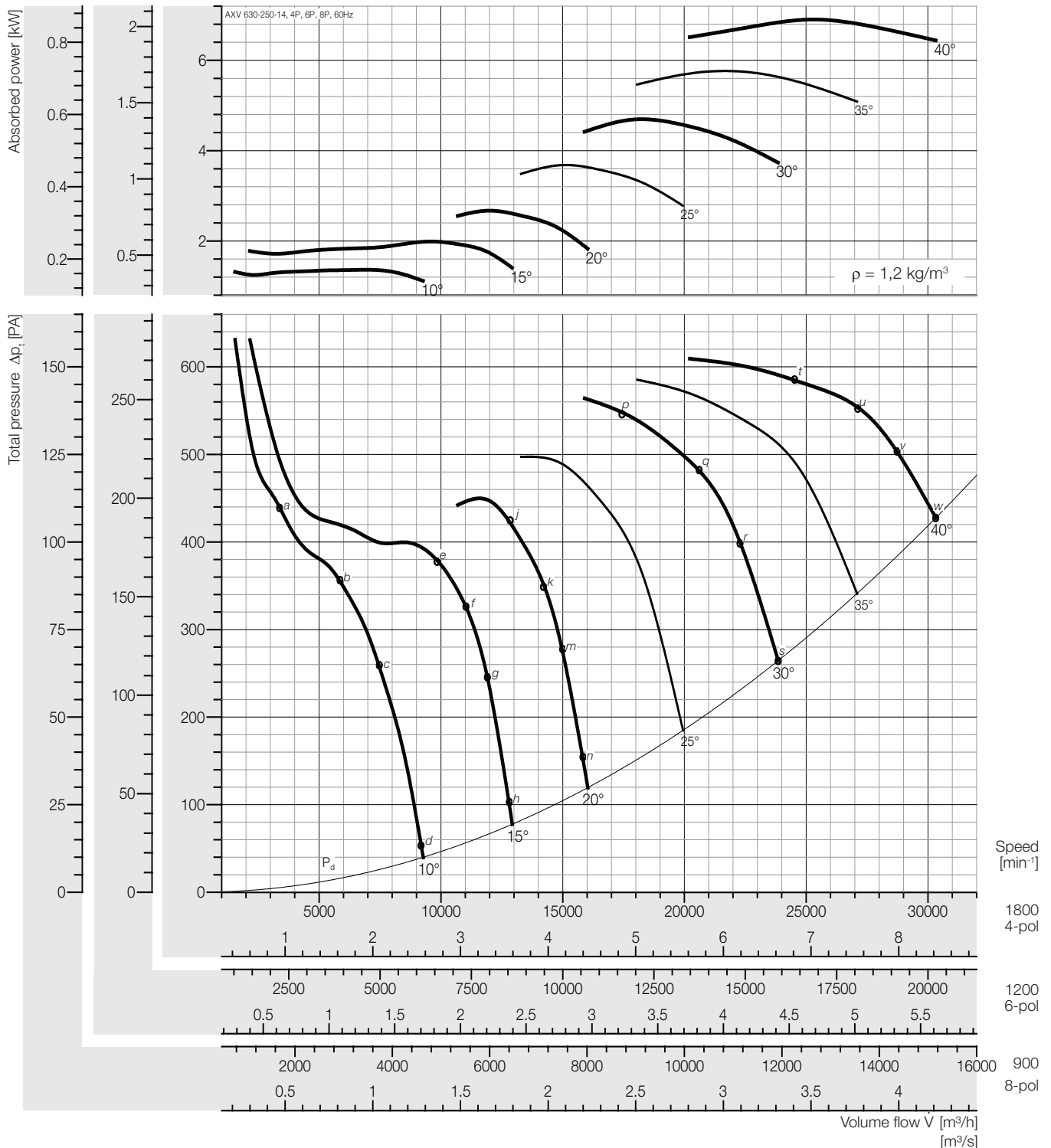

### Peak absorbed power [kW]

n [min <sup>-1</sup> ]	Pitch angle [°]						
	10	15	20	25	30	35	40
900	0,170	0,248	0,334	0,459	0,586	0,720	0,862
Motor	0,37			0,55	0,75		1,1
1200	0,404	0,588	0,791	1,088	1,390	1,707	2,043
Motor	0,55	0,75	1,1		1,5	2,2	
1800	1,362	1,986	2,670	3,673	4,692	5,760	6,894
Motor	1,5	2,2	3,0	4,0	5,5	7,5	

### Sound power level, Lwi(A) [dB(A)]

Lwi(A)	a	b	c	d	e	f	g	h	j	k	m	n	p	q	r	s	t	u	v	w
4P	99	100	99	99	99	97	97	99	98	98	98	99	99	99	101	101	100	101	102	102
6P	87	89	89	89	89	87	87	88	88	87	87	89	88	89	90	90	89	90	90	91
8P	80	81	82	82	82	80	80	81	81	80	80	82	81	82	83	83	82	83	83	84

Plastic Duct

Lwi(A)	a	b	c	d	e	f	g	h	j	k	m	n	p	q	r	s	t	u	v	w
4P	97	98	97	97	97	95	95	97	96	96	96	97	97	97	99	99	98	99	100	100
6P	85	87	87	87	87	85	85	86	86	85	85	87	86	87	88	88	87	88	88	89
8P	78	79	80	80	80	78	78	79	79	78	78	80	79	80	81	81	80	81	81	82

\* Unlined Metal Duct

Fan test laboratory AMCA 210 Test Chamber. Performance certified is for installation type D - Ducted inlet, Ducted outlet. Performance ratings do not include the effects of appurtenances (accessories-belt cover, pulley & belt).

Dimensions + Accessories Page 191 - 194;  
Sound power frequency spectrum L<sub>w</sub> Page 196 - 200.

The A-weighted sound ratings shown have been calculated per AMCA International Standard 301. Values shown are for inlet Lwi(A) sound power levels for installation Type D: ducted inlet, ducted outlet. Ratings include the effects of duct end correction.

\* Sound power level with unlined metal duct were obtained from the test in the reverberant room. Data are not licensed by AMCA.



# Performance Curve

AXV 710-110-3, 60 Hz

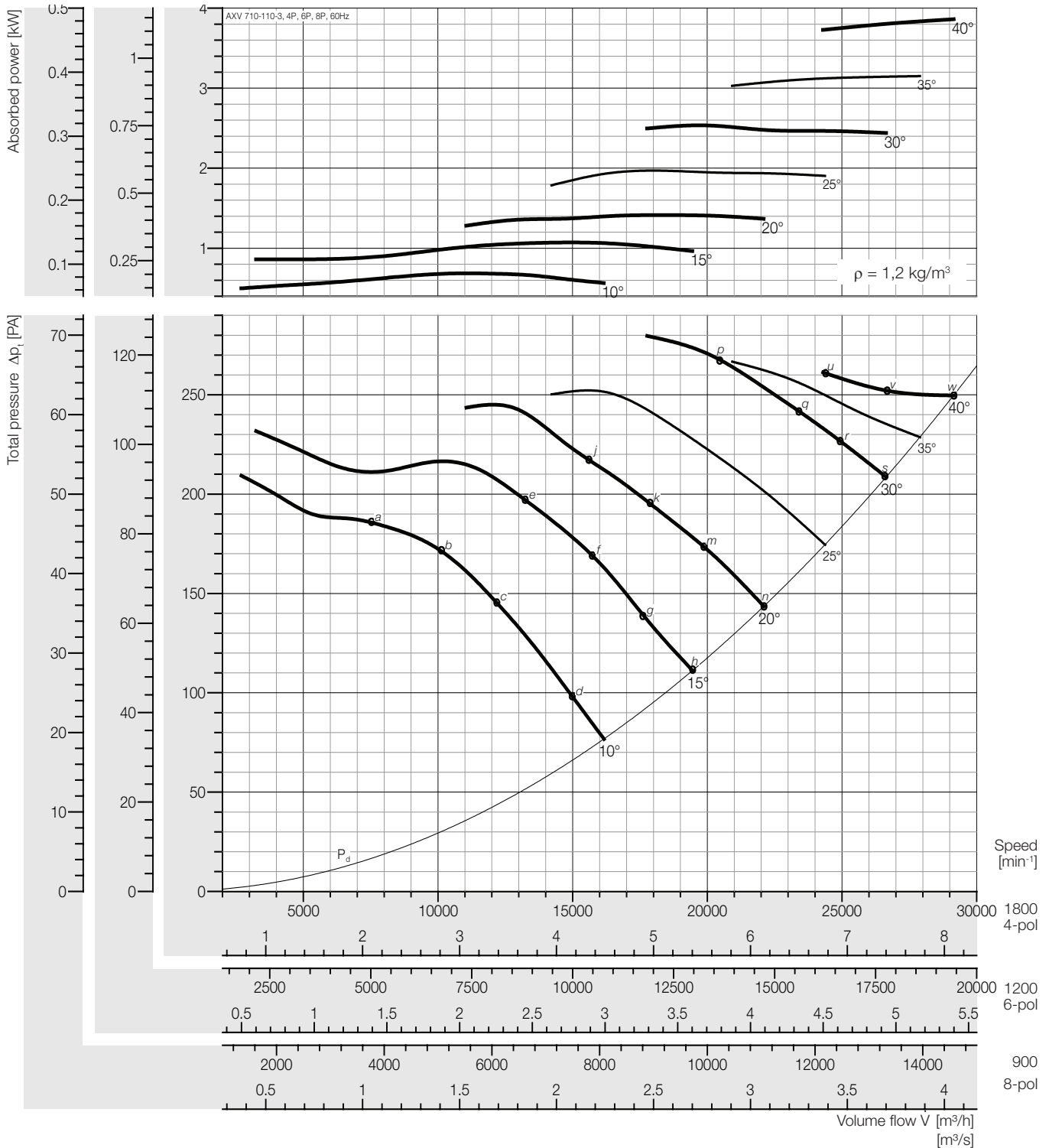

### Peak absorbed power [kW]

n [min <sup>-1</sup> ]	Pitch angle [°]						
	10	15	20	25	30	35	40
900	0,086	0,134	0,177	0,246	0,317	0,394	0,483
Motor	0,37					0,55	
1200	0,203	0,317	0,419	0,583	0,750	0,933	1,144
Motor	0,37		0,55	0,75	1,1		1,5
1800	0,685	1,069	1,414	1,969	2,535	3,150	3,861
Motor	0,75	1,1	1,5	2,2	3,0	4,0	

### Sound power level, Lwi(A) [dB(A)]

Lwi(A)	a	b	c	d	e	f	g	h	j	k	m	n	p	q	r	s	t	u	v	w
4P	98	97	94	90	93	92	92	93	92	92	93	96	97	97	97	97	-	101	99	98
6P	87	86	83	80	83	82	82	83	82	82	83	86	87	87	87	87	-	90	88	88
8P	80	79	76	73	76	75	75	76	75	75	76	79	80	79	79	80	-	82	81	80

*Plastic Duct*

Lwi(A)	a	b	c	d	e	f	g	h	j	k	m	n	p	q	r	s	t	u	v	w
4P	96	95	92	88	91	90	90	91	90	90	91	94	95	95	95	95	-	99	97	96
6P	85	84	81	78	81	80	80	81	80	80	81	84	85	85	85	85	-	88	86	86
8P	78	77	74	71	74	73	73	74	73	73	74	77	78	77	77	78	-	80	79	78

*\* Unlined Metal Duct*

Fan test laboratory AMCA 210 Test Chamber. Performance certified is for installation type D - Ducted inlet, Ducted outlet. Performance ratings do not include the effects of appurtenances (accessories-belt cover, pulley & belt).

Dimensions + Accessories Page 191 - 194;  
Sound power frequency spectrum L<sub>w</sub>(A) Page 196 - 200.

The A-weighted sound ratings shown have been calculated per AMCA International Standard 301. Values shown are for inlet LwiA sound power levels for installation Type D: ducted inlet, ducted outlet. Ratings include the effects of duct end correction.

\* Sound power level with unlined metal duct were obtained from the test in the reverberant room. Data are not licensed by AMCA.



# Performance Curve

AXV 710-110-6, 60 Hz

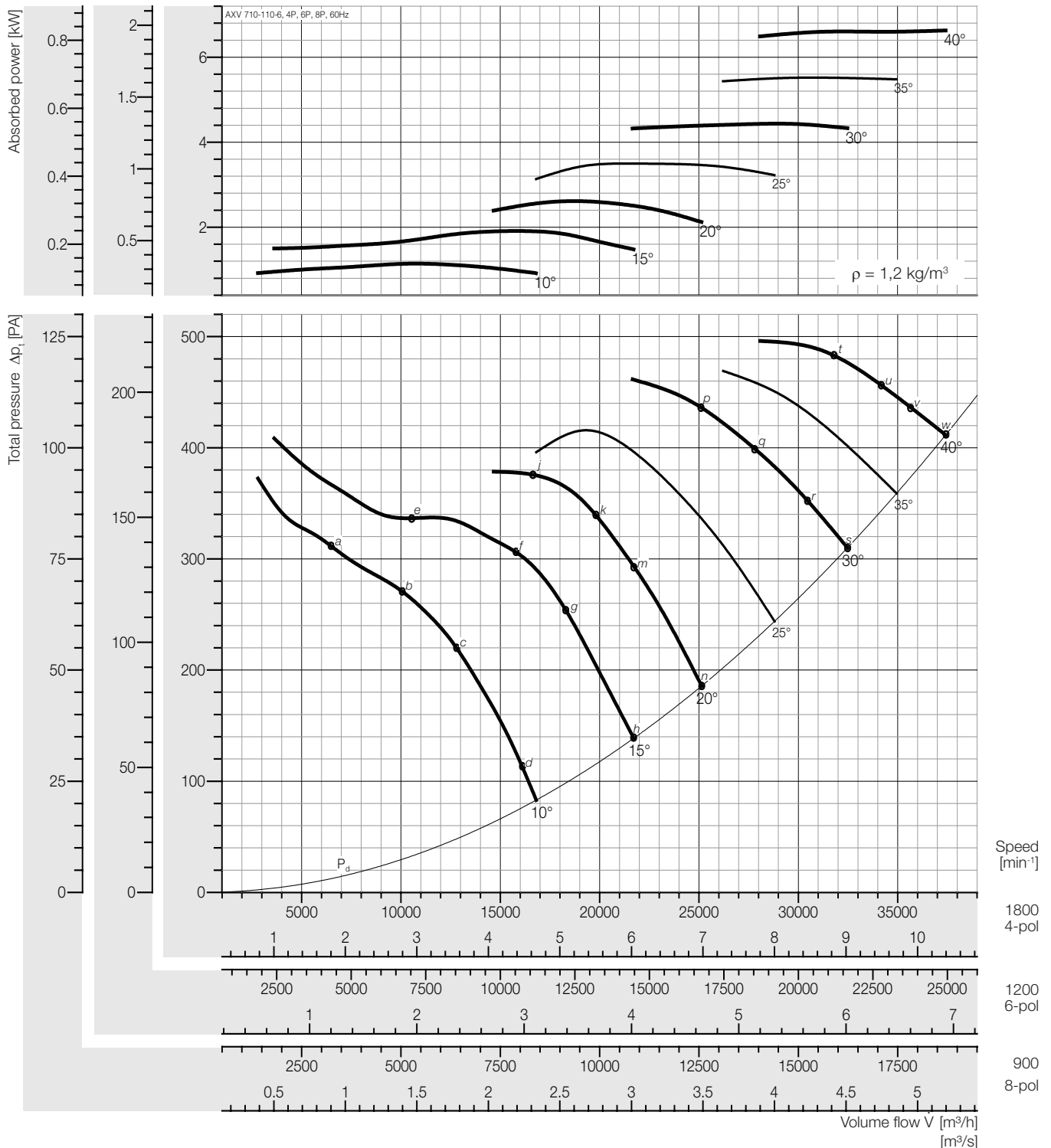

### Peak absorbed power [kW]

n [min <sup>-1</sup> ]	Pitch angle [°]						
	10	15	20	25	30	35	40
900	0,143	0,239	0,326	0,437	0,555	0,690	0,829
Motor	0,37			0,55	0,75		1,1
1200	0,339	0,566	0,773	1,036	1,315	1,635	1,964
Motor	0,37	0,75	1,1		1,5	2,2	
1800	1,144	1,911	2,610	3,496	4,437	5,519	6,629
Motor	1,5	2,2	3,0	4,0	-		

### Sound power level, Lwi(A) [dB(A)]

Lwi(A)	a	b	c	d	e	f	g	h	j	k	m	n	p	q	r	s	t	u	v	w
4P	97	101	100	94	104	99	96	96	101	99	99	101	100	100	99	103	103	103	103	
6P	86	90	90	84	94	89	86	86	90	87	86	87	89	89	88	92	92	92	92	
8P	79	82	83	77	86	82	78	79	83	80	80	81	82	82	81	85	85	85	85	

Plastic Duct

Lwi(A)	a	b	c	d	e	f	g	h	j	k	m	n	p	q	r	s	t	u	v	w
4P	95	99	98	92	102	97	94	94	99	97	97	99	98	98	97	101	101	101	101	
6P	84	88	88	82	92	87	84	84	88	85	84	85	87	87	86	90	90	90	90	
8P	77	80	81	75	84	80	76	77	81	78	78	79	80	80	79	83	83	83	83	

\* Unlined Metal Duct

Fan test laboratory AMCA 210 Test Chamber. Performance certified is for installation type D - Ducted inlet, Ducted outlet. Performance ratings do not include the effects of appurtenances (accessories-belt cover, pulley & belt).

Dimensions + Accessories Page 191 - 194;  
Sound power frequency spectrum L<sub>w</sub>(A) Page 196 - 200.

The A-weighted sound ratings shown have been calculated per AMCA International Standard 301. Values shown are for inlet Lwi(A) sound power levels for installation Type D: ducted inlet, ducted outlet. Ratings include the effects of duct end correction.

\* Sound power level with unlined metal duct were obtained from the test in the reverberant room. Data are not licensed by AMCA.



# Performance Curve

AXV 710-150-5, 60 Hz

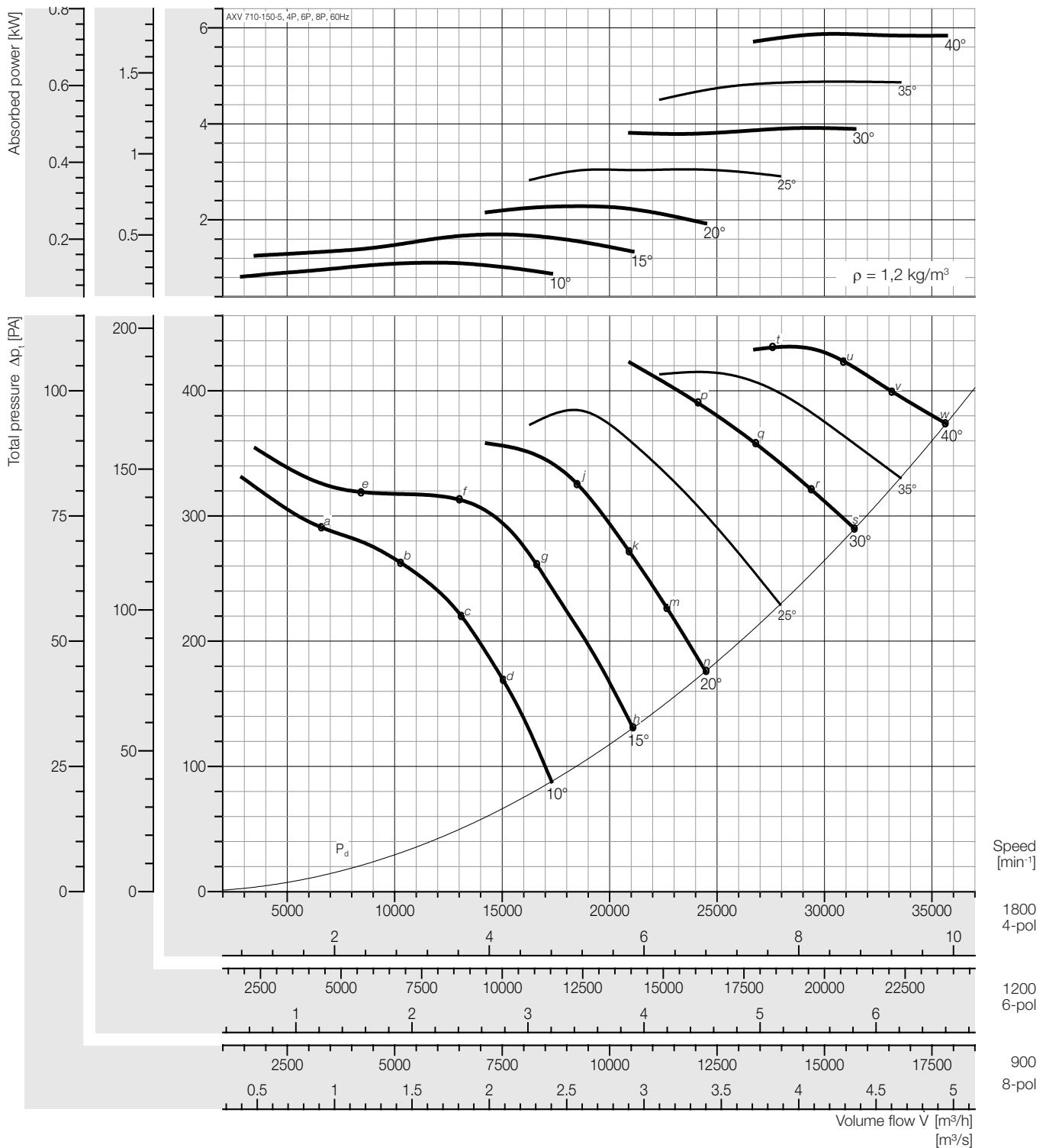

### Peak absorbed power [kW]

n [min <sup>-1</sup> ]	Pitch angle [°]						
	10	15	20	25	30	35	40
900	0,138	0,212	0,286	0,381	0,489	0,610	0,734
Motor	0,37			0,55		0,75	
1200	0,328	0,502	0,677	0,904	1,160	1,446	1,740
Motor	0,37	0,55	0,75	1,1	1,5		2,2
1800	1,106	1,696	2,285	3,050	3,914	4,879	5,874
Motor	1,5	2,2	3,0	4,0			-

### Sound power level, Lwi(A) [dB(A)]

Lwi(A)	a	b	c	d	e	f	g	h	j	k	m	n	p	q	r	s	t	u	v	w
4P	100	101	98	96	100	100	96	96	95	95	95	96	100	100	101	102	103	102	103	103
6P	89	91	88	86	90	90	86	86	85	85	85	86	89	89	90	90	93	92	93	93
8P	81	83	81	78	82	83	78	77	78	78	77	78	82	82	82	82	85	85	85	85

Plastic Duct

Lwi(A)	a	b	c	d	e	f	g	h	j	k	m	n	p	q	r	s	t	u	v	w
4P	98	99	96	94	98	98	94	94	93	93	93	94	98	98	99	100	101	100	101	101
6P	87	89	86	84	88	88	84	84	83	83	83	84	87	87	88	88	91	90	91	91
8P	79	81	79	76	80	81	76	75	76	76	75	76	80	80	80	80	83	83	83	83

\* Unlined Metal Duct

Fan test laboratory AMCA 210 Test Chamber. Performance certified is for installation type D - Ducted inlet, Ducted outlet. Performance ratings do not include the effects of appurtenances (accessories-belt cover, pulley & belt).

Dimensions + Accessories Page 191 - 194;  
Sound power frequency spectrum L<sub>wref</sub> Page 196 - 200.

The A-weighted sound ratings shown have been calculated per AMCA International Standard 301. Values shown are for inlet LwiA sound power levels for installation Type D: ducted inlet, ducted outlet. Ratings include the effects of duct end correction.

\* Sound power level with unlined metal duct were obtained from the test in the reverberant room. Data are not licensed by AMCA.



# Performance Curve

AXV 710-150-10, 4P, 6P, 8P, 60Hz

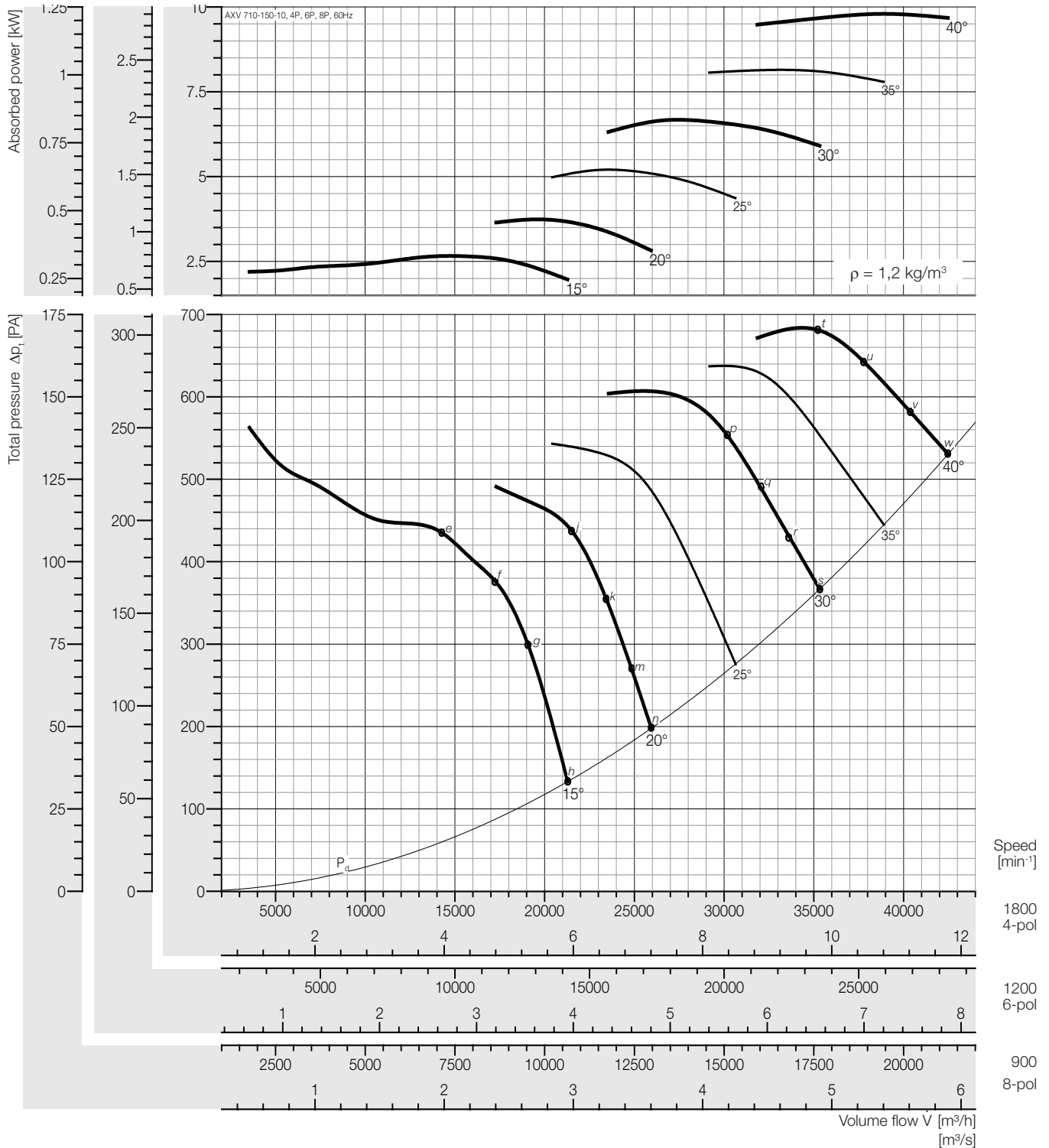

### Peak absorbed power [kW]

n [min <sup>-1</sup> ]	Pitch angle [°]						
	10	15	20	25	30	35	40
900	-	0,332	0,467	0,651	0,834	1,018	1,225
Motor		0,37	0,55	0,75	1,1		1,5
1200	-	0,788	1,108	1,542	1,978	2,414	2,903
Motor		1,1	1,5	2,2		3,0	
1800	-	2,658	3,738	5,205	6,676	8,146	9,796
Motor		3,0	4,0	-			

### Sound power level, Lwi(A) [dB(A)]

Lwi(A)	a	b	c	d	e	f	g	h	j	k	m	n	p	q	r	s	t	u	v	w
4P	-	-	-	-	104	100	98	98	99	98	100	100	102	102	102	103	103	103	104	104
6P	-	-	-	-	94	90	88	89	89	89	90	91	92	92	92	93	93	93	93	94
8P	-	-	-	-	86	83	81	81	81	81	82	82	85	84	85	85	86	86	86	86

Plastic Duct

Lwi(A)	a	b	c	d	e	f	g	h	j	k	m	n	p	q	r	s	t	u	v	w
4P	-	-	-	-	102	98	96	96	97	96	98	98	100	100	100	101	101	101	102	102
6P	-	-	-	-	92	88	86	87	87	87	88	89	90	90	90	91	91	91	91	92
8P	-	-	-	-	84	81	79	79	79	79	80	80	83	82	83	83	84	84	84	84

\* Unlined Metal Duct

Fan test laboratory AMCA 210 Test Chamber. Performance certified is for installation type D - Ducted inlet, Ducted outlet. Performance ratings do not include the effects of appurtenances (accessories-belt cover, pulley & belt).

Dimensions + Accessories Page 191 - 194;  
Sound power frequency spectrum L<sub>w</sub> Page 196 - 200.

The A-weighted sound ratings shown have been calculated per AMCA International Standard 301. Values shown are for inlet Lwi(A) sound power levels for installation Type D: ducted inlet, ducted outlet. Ratings include the effects of duct end correction.

\* Sound power level with unlined metal duct were obtained from the test in the reverberant room. Data are not licensed by AMCA.



# Performance Curve

AXV 710-250-7, 4P, 6P, 8P, 60Hz

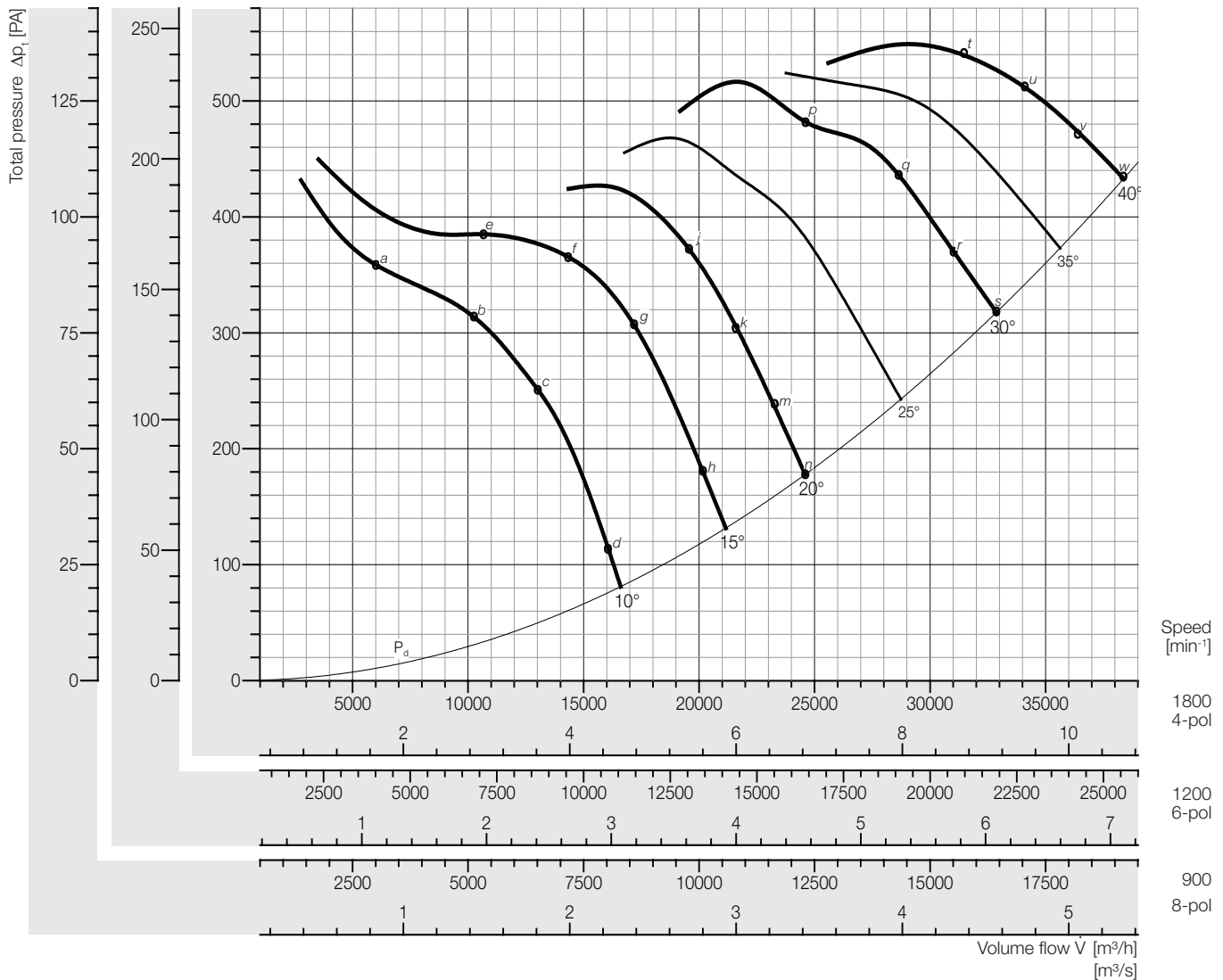
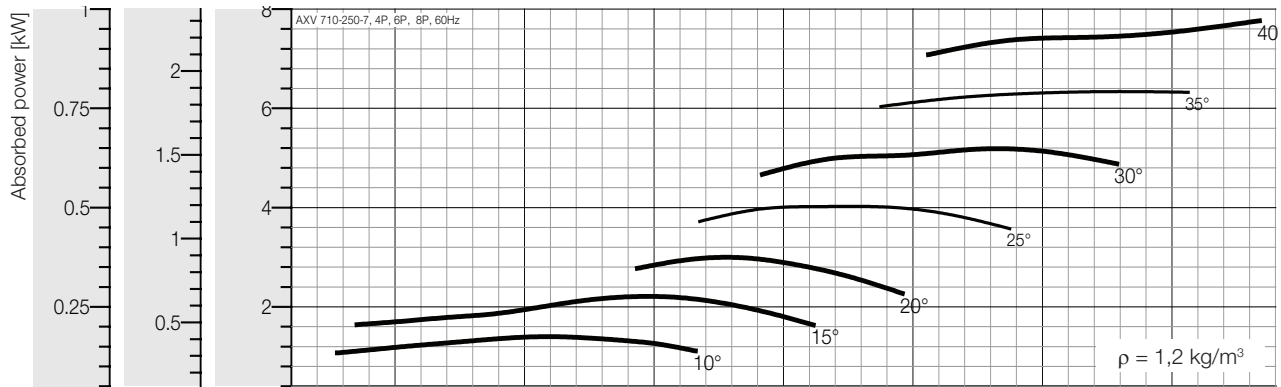

### Peak absorbed power [kW]

n [min <sup>-1</sup> ]	Pitch angle [°]						
	10	15	20	25	30	35	40
900	0,175	0,276	0,375	0,503	0,648	0,792	0,971
Motor	0,37		0,55		0,75	1,1	
1200	0,414	0,654	0,888	1,192	1,537	1,878	2,301
Motor	0,55	0,75	1,1	1,5	2,2		3,0
1800	1,397	2,207	2,998	4,023	5,187	6,338	7,766
Motor	1,5	3,0		5,5		7,5	11

### Sound power level, Lwi(A) [dB(A)]

Lwi(A)	a	b	c	d	e	f	g	h	j	k	m	n	p	q	r	s	t	u	v	w
4P	100	103	101	96	104	102	97	97	97	97	97	92	101	102	102	103	103	104	104	104
6P	90	92	91	86	93	92	87	87	87	86	87	82	91	91	91	92	93	93	94	94
8P	82	85	84	79	85	84	79	80	80	79	80	75	83	84	84	84	86	86	86	87

Plastic Duct

Lwi(A)	a	b	c	d	e	f	g	h	j	k	m	n	p	q	r	s	t	u	v	w
4P	98	101	99	94	102	100	95	95	95	95	95	90	99	100	100	101	101	102	102	102
6P	88	90	89	84	91	90	85	85	85	84	85	80	89	89	89	90	91	91	92	92
8P	80	83	82	77	83	82	77	78	78	77	78	73	81	82	82	82	84	84	84	85

\* Unlined Metal Duct

Fan test laboratory AMCA 210 Test Chamber. Performance certified is for installation type D - Ducted inlet, Ducted outlet. Performance ratings do not include the effects of appurtenances (accessories-belt cover, pulley & belt).

Dimensions + Accessories Page 191 - 194;  
Sound power frequency spectrum L<sub>w</sub>(A) Page 196 - 200.

The A-weighted sound ratings shown have been calculated per AMCA International Standard 301. Values shown are for inlet LwiA sound power levels for installation Type D: ducted inlet, ducted outlet. Ratings include the effects of duct end correction.

\* Sound power level with unlined metal duct were obtained from the test in the reverberant room. Data are not licensed by AMCA.



# Performance Curve

AXV 710-250-9, 60 Hz

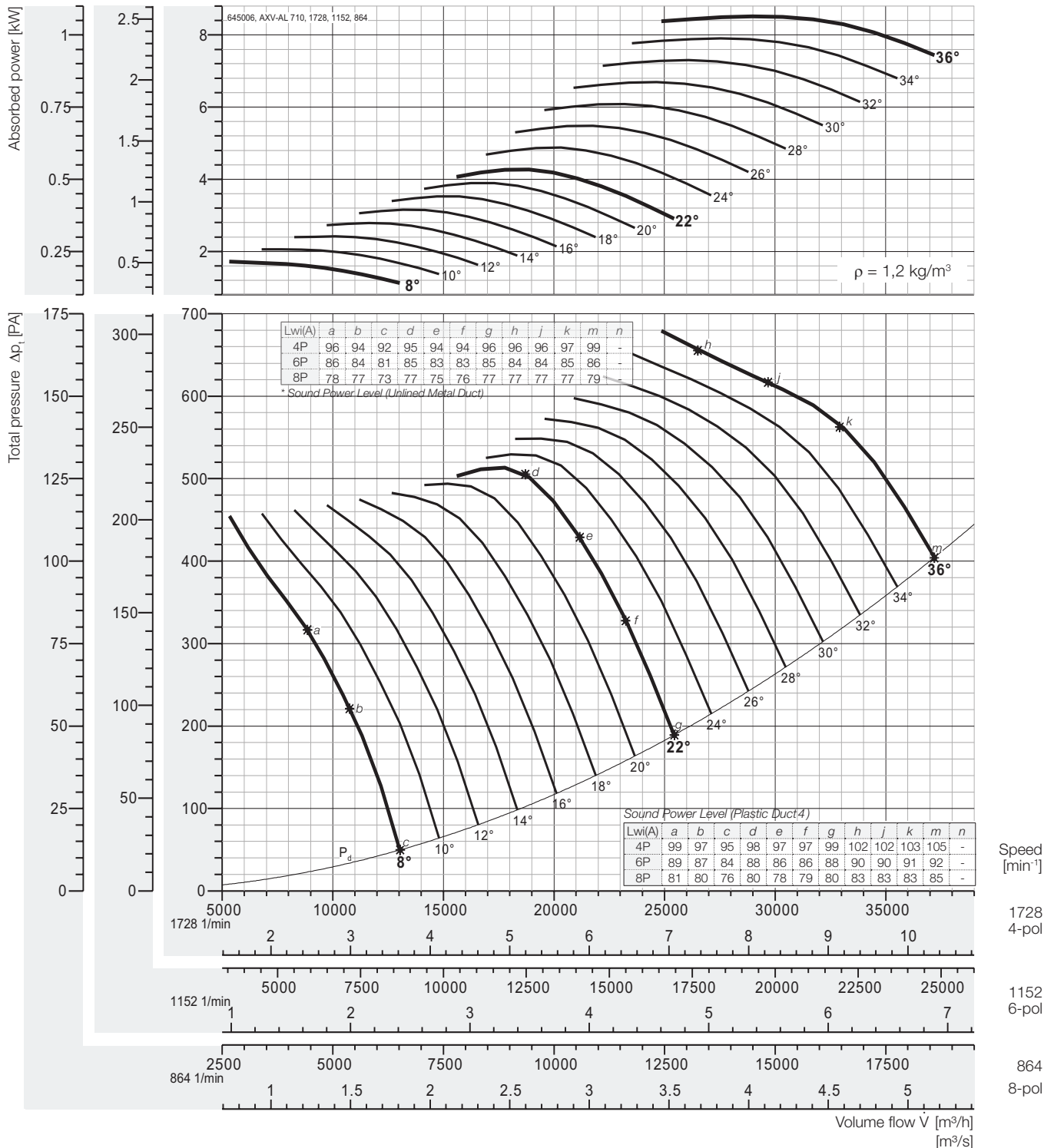

## Peak absorbed power [kW]

n [min <sup>-1</sup> ]	Pitch angle [°]																
	8	10	12	14	16	18	20	22	24	26	28	30	32	34	36	38	40
864 motor	0,215	0,257	0,302	0,348	0,394	0,441	0,487	0,534	0,610	0,685	0,761	0,837	0,912	0,988	1,06	-	-
	0,37				0,55				0,75		1,1						
1152 motor	0,510	0,609	0,715	0,825	0,935	1,04	1,15	1,27	1,45	1,62	1,80	1,98	2,16	2,34	2,52	-	-
	0,55	0,75		1,1			1,5			2,2				3			
1728 motor	1,72	2,06	2,41	2,78	3,15	3,52	3,90	4,27	4,88	5,48	6,09	6,69	7,30	7,91	8,51	-	-
	2,2		3		4			5,5			7,5			11			

Fan test laboratory AMCA 210 Test Chamber. Performance certified is for installation type D - Ducted inlet, Ducted outlet. Performance ratings do not include the effects of appurtenances (accessories-belt cover, pulley & belt).

Dimensions + Accessories Page 191 - 194;  
Sound power frequency spectrum  $L_{wref}$  Page 196 - 200.

The A-weighted sound ratings shown have been calculated per AMCA International Standard 301. Values shown are for inlet LwiA sound power levels for installation Type D: ducted inlet, ducted outlet. Ratings include the effects of duct end correction.

\* Sound power level with unlined metal duct were obtained from the test in the reverberant room. Data are not licensed by AMCA.





# Performance Curve

AXV 710-250-14, 60 Hz

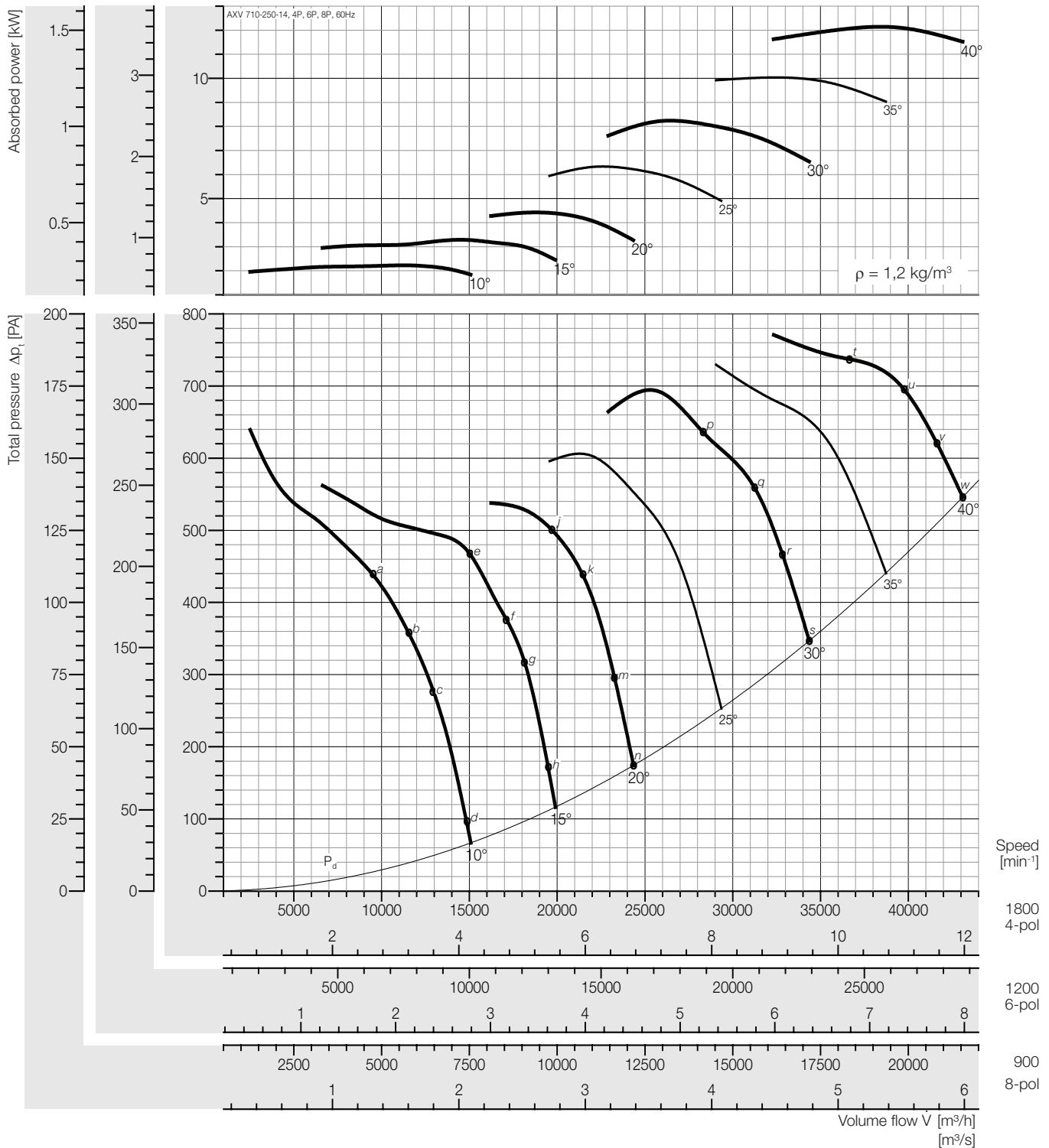

### Peak absorbed power [kW]

n [min <sup>-1</sup> ]	Pitch angle [°]						
	10	15	20	25	30	35	40
900	0,278	0,410	0,553	0,791	1,030	1,254	1,518
Motor	0,37	0,55	0,75	1,1		1,5	2,2
1200	0,659	0,971	1,311	1,876	2,441	2,973	3,598
Motor	0,75	1,1	1,5	2,2	3,0	4,0	
1800	2,225	3,278	4,424	6,331	8,237	10,03	12,14
Motor	3,0	4,0	5,5	7,5	11		-

### Sound power level, Lwi(A) [dB(A)]

Lwi(A)	a	b	c	d	e	f	g	h	j	k	m	n	p	q	r	s	t	u	v	w
4P	103	103	103	100	105	101	99	100	101	100	100	101	103	103	104	105	105	105	106	106
6P	92	93	93	91	95	91	89	91	91	90	90	91	92	93	94	94	95	95	96	96
8P	84	86	86	84	87	84	82	83	84	83	83	84	85	86	86	87	88	88	88	88

Plastic Duct

Lwi(A)	a	b	c	d	e	f	g	h	j	k	m	n	p	q	r	s	t	u	v	w
4P	101	101	101	98	103	99	97	98	99	98	98	99	101	101	102	103	103	103	104	104
6P	90	91	91	89	93	89	87	89	89	88	88	89	90	91	92	92	93	93	94	94
8P	82	84	84	82	85	82	80	81	82	81	81	82	83	84	84	85	86	86	86	86

\* Unlined Metal Duct

Fan test laboratory AMCA 210 Test Chamber. Performance certified is for installation type D - Ducted inlet, Ducted outlet. Performance ratings do not include the effects of appurtenances (accessories-belt cover, pulley & belt).

Dimensions + Accessories Page 191 ~ 194;  
Sound power frequency spectrum L<sub>w,ref</sub> Page 196 ~ 200.

The A-weighted sound ratings shown have been calculated per AMCA International Standard 301. Values shown are for inlet LwiA sound power levels for installation Type D: ducted inlet, ducted outlet. Ratings include the effects of duct end correction.

\* Sound power level with unlined metal duct were obtained from the test in the reverberant room. Data are not licensed by AMCA.



# Performance Curve

AXV 800-150-5, 60 Hz

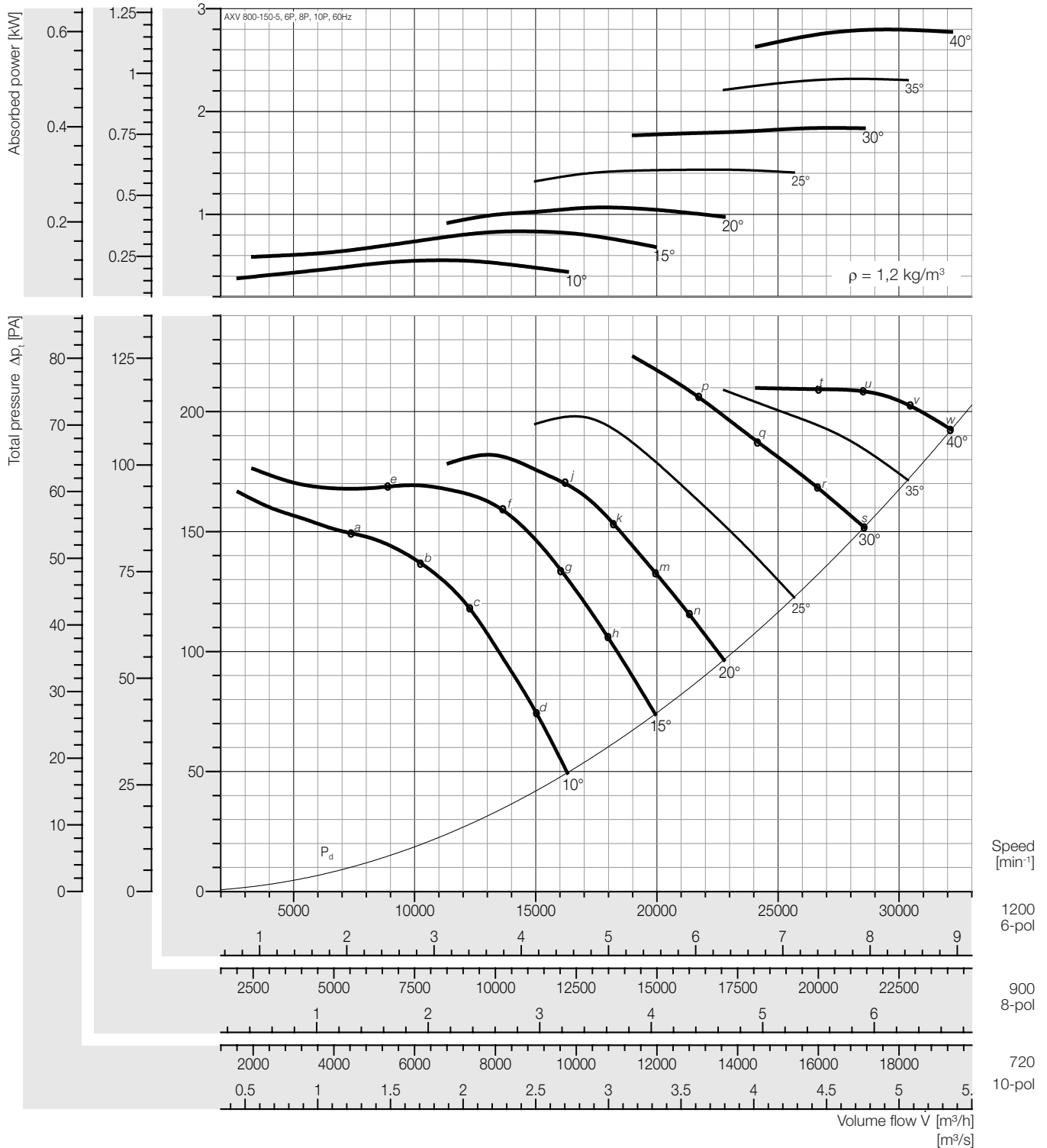

### Peak absorbed power [kW]

n [min <sup>-1</sup> ]	Pitch angle [°]						
	10	15	20	25	30	35	40
720	0,119	0,180	0,231	0,310	0,397	0,500	0,604
Motor	0,37				0,55		0,75
900	0,233	0,352	0,450	0,605	0,776	0,978	1,180
Motor	0,37		0,55	0,75	1,1		1,5
1200	0,552	0,835	1,067	1,435	1,840	2,317	2,797
Motor	0,75	1,1		1,5	2,2	-	

### Sound power level, Lwi(A) [dB(A)]

Lwi(A)	a	b	c	d	e	f	g	h	j	k	m	n	p	q	r	s	t	u	v	w
6P	95	94	91	90	96	91	89	89	90	91	91	91	94	93	94	94	95	94	95	95
8P	87	87	84	82	88	83	81	81	82	82	82	82	85	85	85	86	87	87	87	87
10P	81	81	78	76	82	77	75	75	76	77	76	77	79	79	79	80	81	81	81	81

Plastic Duct

Lwi(A)	a	b	c	d	e	f	g	h	j	k	m	n	p	q	r	s	t	u	v	w
6P	93	92	89	88	94	89	87	87	88	89	89	89	92	91	92	92	93	92	93	93
8P	85	85	81	80	86	81	79	79	80	80	80	80	83	83	83	84	85	85	85	85
10P	79	79	76	74	80	75	73	73	74	75	74	75	77	77	77	78	79	79	79	79

\* Unlined Metal Duct

Fan test laboratory AMCA 210 Test Chamber. Performance certified is for installation type D - Ducted inlet, Ducted outlet. Performance ratings do not include the effects of appurtenances (accessories-belt cover, pulley & belt).

Dimensions + Accessories Page 191 - 194;  
Sound power frequency spectrum L<sub>w</sub>(f) Page 196 - 200.

The A-weighted sound ratings shown have been calculated per AMCA International Standard 301. Values shown are for inlet Lwi(A) sound power levels for installation Type D: ducted inlet, ducted outlet. Ratings include the effects of duct end correction.

\* Sound power level with unlined metal duct were obtained from the test in the reverberant room. Data are not licensed by AMCA.



# Performance Curve

AXV 800-150-10, 60 Hz

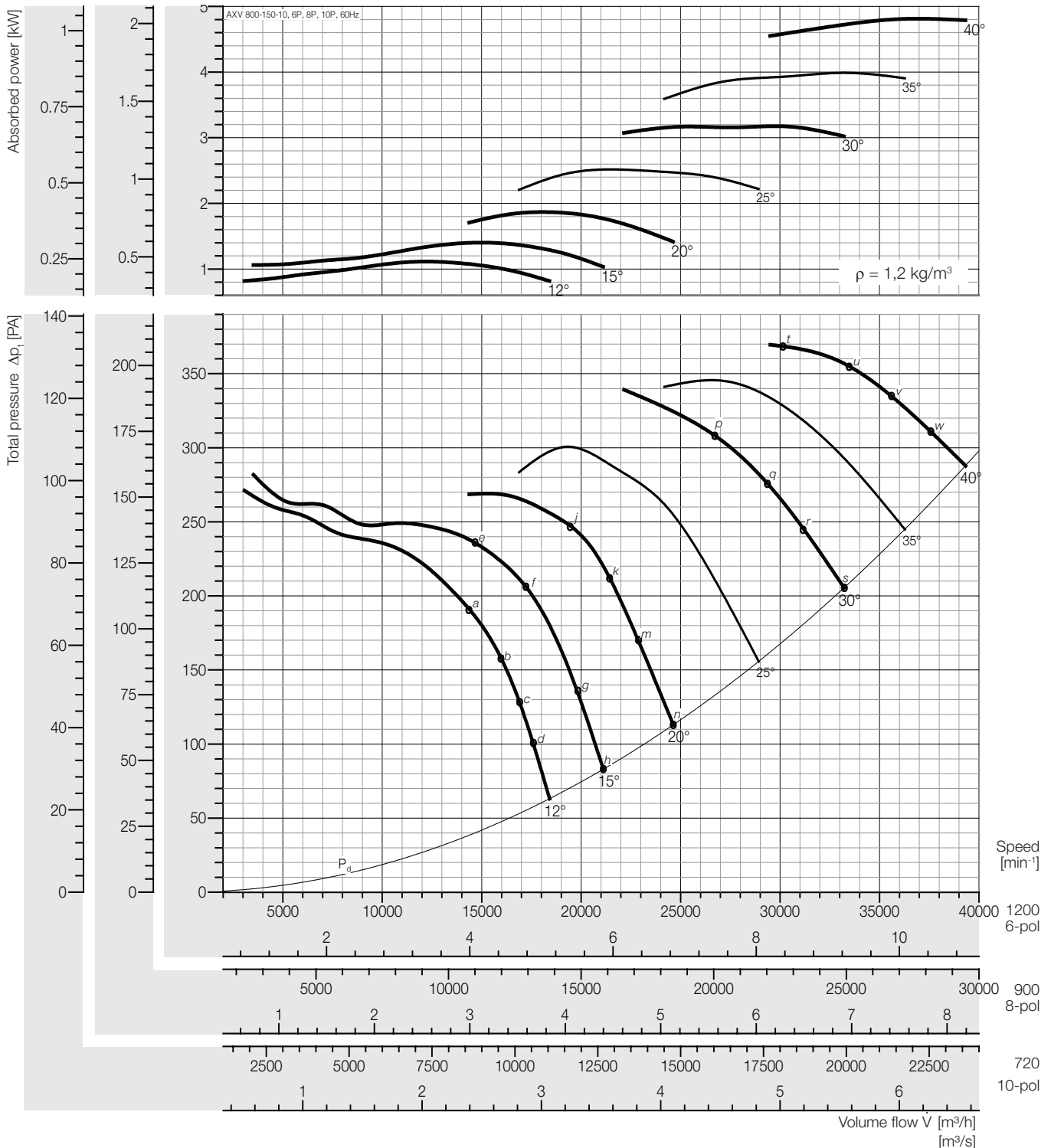

### Peak absorbed power [kW]

n [min <sup>-1</sup> ]	Pitch angle [°]						
	10	15	20	25	30	35	40
720	0,240	0,303	0,403	0,543	0,686	0,861	1,039
Motor	0,37		0,55		0,75		1,1
900	0,469	0,592	0,788	1,060	1,339	1,682	2,030
Motor	0,55	0,75	1,1		1,5	-	
1200	1,111	1,403	1,867	2,514	3,175	3,987	4,812
Motor	1,5	1,5	2,2		-		

### Sound power level, Lwi(A) [dB(A)]

Lwi(A)	a	b	c	d	e	f	g	h	j	k	m	n	p	q	r	s	t	u	v	w
6P	96	93	92	93	97	95	94	94	95	95	95	95	96	96	96	96	96	96	97	97
8P	89	85	84	85	89	86	85	86	86	86	86	86	87	87	87	87	87	88	88	89
10P	83	79	79	79	83	80	80	80	80	80	80	81	81	81	81	82	82	83	83	83

Plastic Duct

Lwi(A)	a	b	c	d	e	f	g	h	j	k	m	n	p	q	r	s	t	u	v	w
6P	94	91	90	91	95	93	92	92	93	93	93	93	94	94	94	94	94	94	95	95
8P	87	83	82	83	87	84	83	84	84	84	84	84	85	85	85	85	86	86	87	87
10P	81	77	77	77	81	78	78	78	78	78	78	79	79	79	79	80	80	81	81	81

\* Unlined Metal Duct

Fan test laboratory AMCA 210 Test Chamber. Performance certified is for installation type D - Ducted inlet, Ducted outlet. Performance ratings do not include the effects of appurtenances (accessories-belt cover, pulley & belt).

Dimensions + Accessories Page 191 - 194;  
Sound power frequency spectrum L<sub>w(f)</sub> Page 196 - 200.

The A-weighted sound ratings shown have been calculated per AMCA International Standard 301. Values shown are for inlet Lwi(A) sound power levels for installation Type D: ducted inlet, ducted outlet. Ratings include the effects of duct end correction.

\* Sound power level with unlined metal duct were obtained from the test in the reverberant room. Data are not licensed by AMCA.



# Performance Curve

AXV 800-250-7, 60 Hz

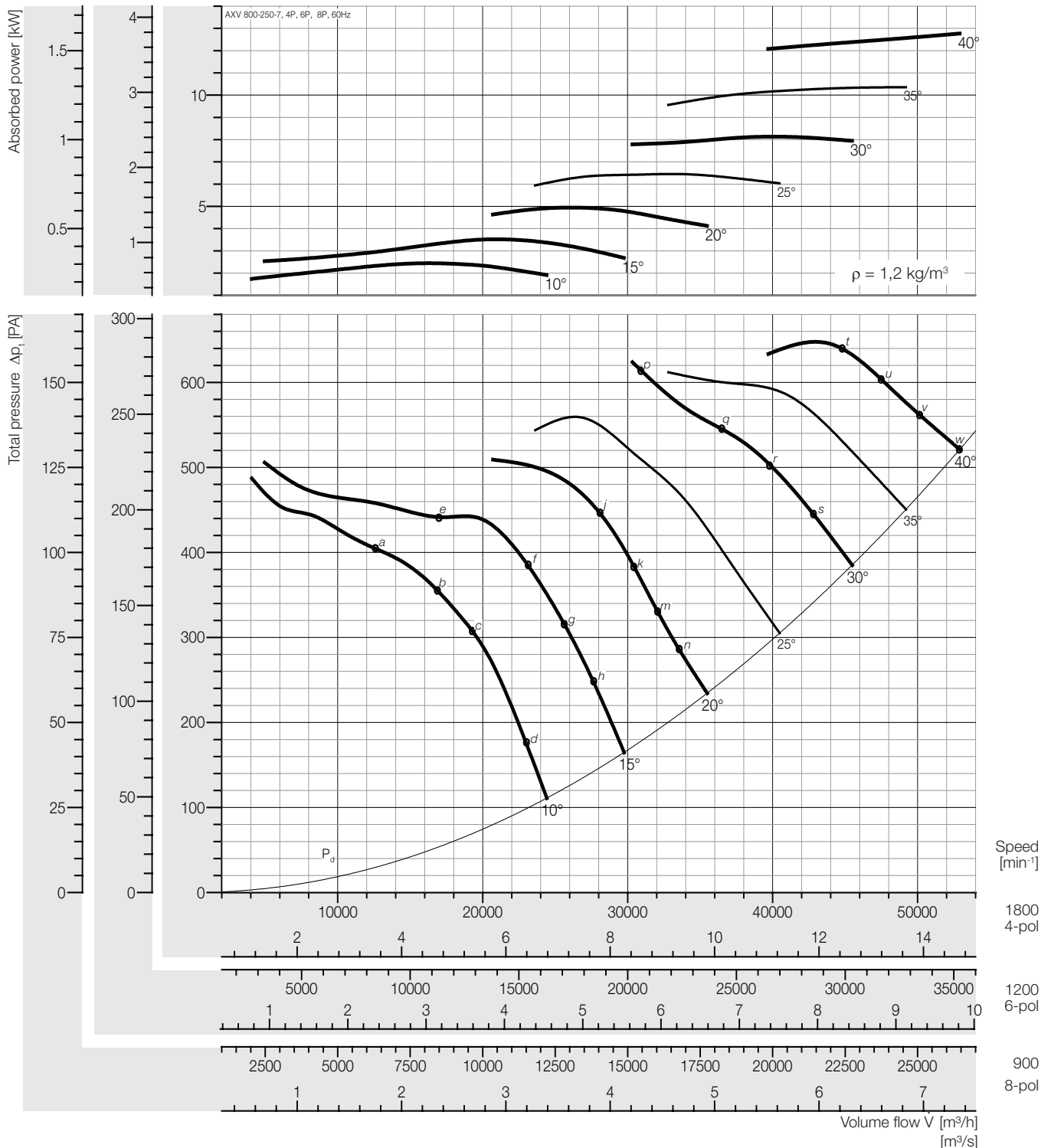

## Peak absorbed power [kW]

n [min <sup>-1</sup> ]	Pitch angle [°]						
	10	15	20	25	30	35	40
900	0,304	0,439	0,618	0,807	1,017	1,295	1,596
Motor	0,37	0,55	0,75	1,1		1,5	2,2
1200	0,721	1,041	1,464	1,912	2,410	3,069	3,784
Motor	0,75	1,1	1,5	2,2	3,0	4,0	
1800	2,434	3,514	4,941	6,454	8,132	10,36	12,77
Motor	3,0	4,0	5,5	7,5	11		-

## Sound power level, Lwi(A) [dB(A)]

Lwi(A)	a	b	c	d	e	f	g	h	j	k	m	n	p	q	r	s	t	u	v	w
4P	106	105	103	102	106	101	100	100	101	101	101	101	101	102	102	103	106	106	106	106
6P	96	95	93	91	96	91	90	90	90	91	91	91	91	92	92	92	95	95	96	96
8P	88	88	86	84	89	84	83	83	83	83	83	84	83	84	84	85	88	88	88	89

Plastic Duct

Lwi(A)	a	b	c	d	e	f	g	h	j	k	m	n	p	q	r	s	t	u	v	w
4P	104	103	101	100	104	99	98	98	99	99	99	99	99	100	100	101	104	104	104	104
6P	94	93	91	89	94	89	88	88	88	89	89	89	89	90	90	90	93	93	94	94
8P	86	86	84	82	87	82	81	81	81	81	81	82	81	82	82	83	86	86	86	87

\* Unlined Metal Duct

Fan test laboratory AMCA 210 Test Chamber. Performance certified is for installation type D - Ducted inlet, Ducted outlet. Performance ratings do not include the effects of appurtenances (accessories-belt cover, pulley & belt).

Dimensions + Accessories Page 191 - 194;  
Sound power frequency spectrum L<sub>w</sub> Page 196 - 200.

The A-weighted sound ratings shown have been calculated per AMCA International Standard 301. Values shown are for inlet Lwi(A) sound power levels for installation Type D: ducted inlet, ducted outlet. Ratings include the effects of duct end correction.

\* Sound power level with unlined metal duct were obtained from the test in the reverberant room. Data are not licensed by AMCA.



# Performance Curve

AXV 800-250-9, 60 Hz

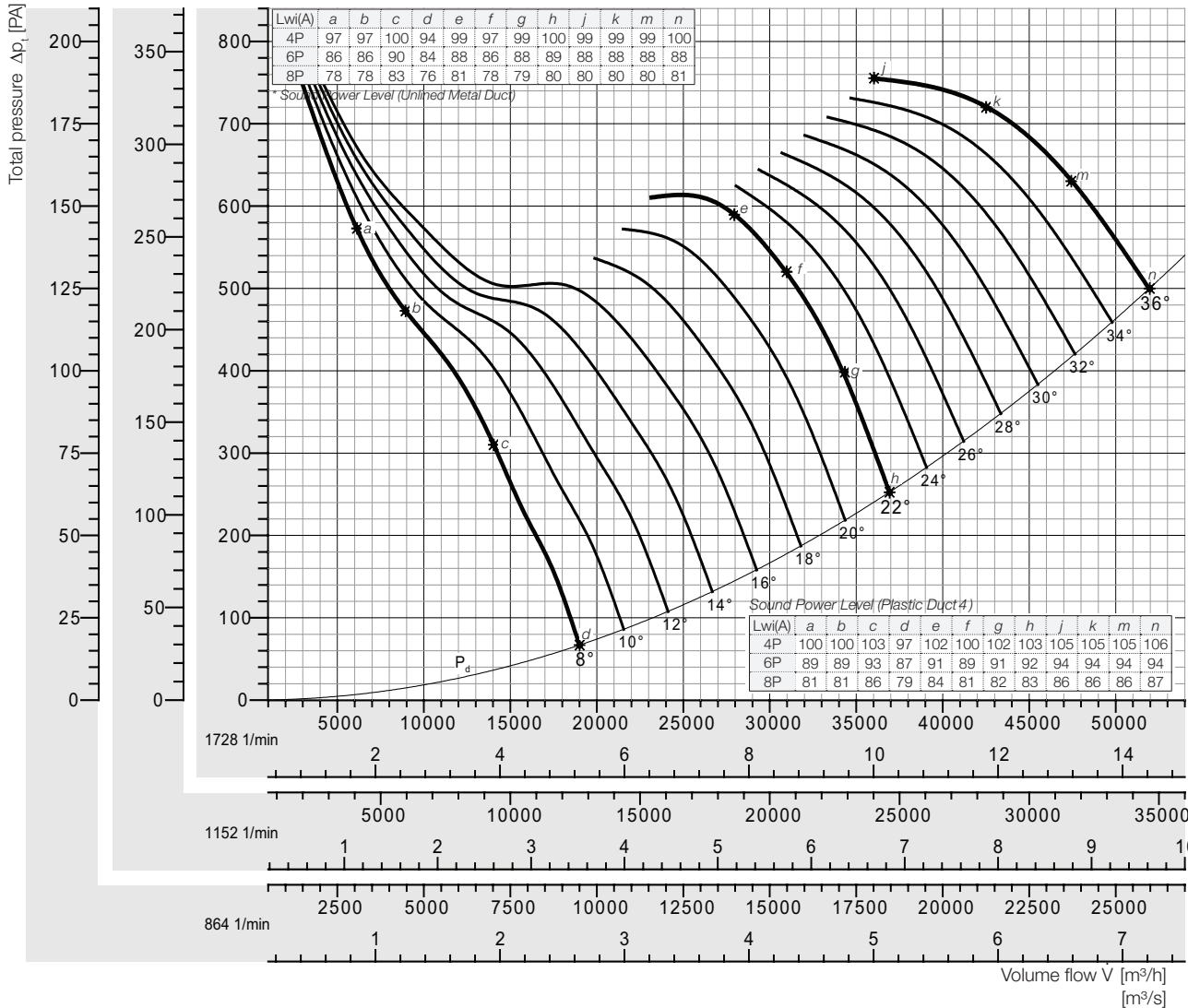
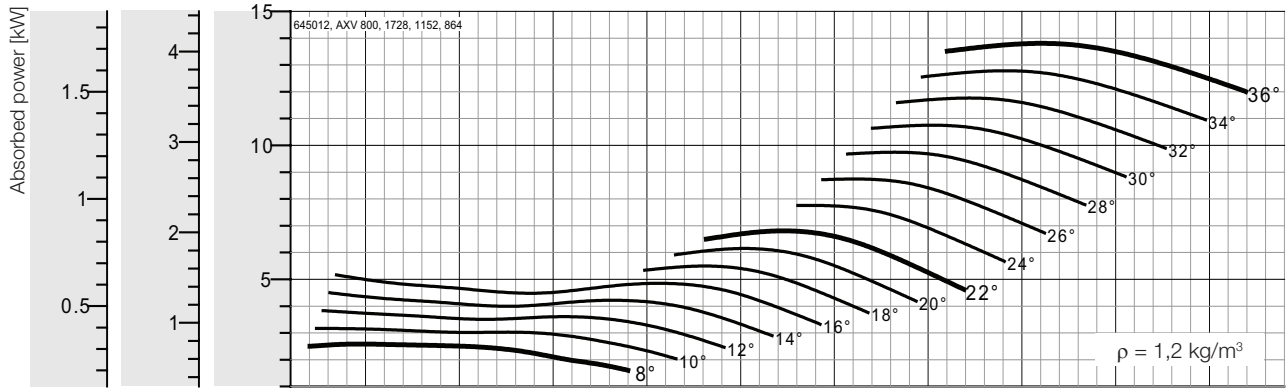

## Peak absorbed power [kW]

n [min <sup>-1</sup> ]	Pitch angle [°]																
	8	10	12	14	16	18	20	22	24	26	28	30	32	34	36	38	40
864 motor	0,323	0,396	0,479	0,562	0,645	0,687	0,769	0,851	0,970	1,09	1,22	1,34	1,47	1,60	1,73	-	-
1152 motor	0,765	0,938	1,14	1,33	1,53	1,63	1,82	2,02	2,30	2,59	2,89	3,19	3,49	3,79	4,09	-	-
1728 motor	2,58	3,17	3,83	4,50	5,16	5,49	6,15	6,81	7,76	8,74	9,74	10,8	11,8	12,9	13,8	-	-

Fan test laboratory AMCA 210 Test Chamber. Performance certified is for installation type D - Ducted inlet, Ducted outlet. Performance ratings do not include the effects of appurtenances (accessories-belt cover, pulley & belt).

Dimensions + Accessories Page 191 - 194;  
Sound power frequency spectrum L<sub>w</sub> Page 196 - 200.

The A-weighted sound ratings shown have been calculated per AMCA International Standard 301. Values shown are for inlet Lw(A) sound power levels for installation Type D: ducted inlet, ducted outlet. Ratings include the effects of duct end correction.

\* Sound power level with unlined metal duct were obtained from the test in the reverberant room. Data are not licensed by AMCA.



# Performance Curve

AXV 800-250-14, 60 Hz

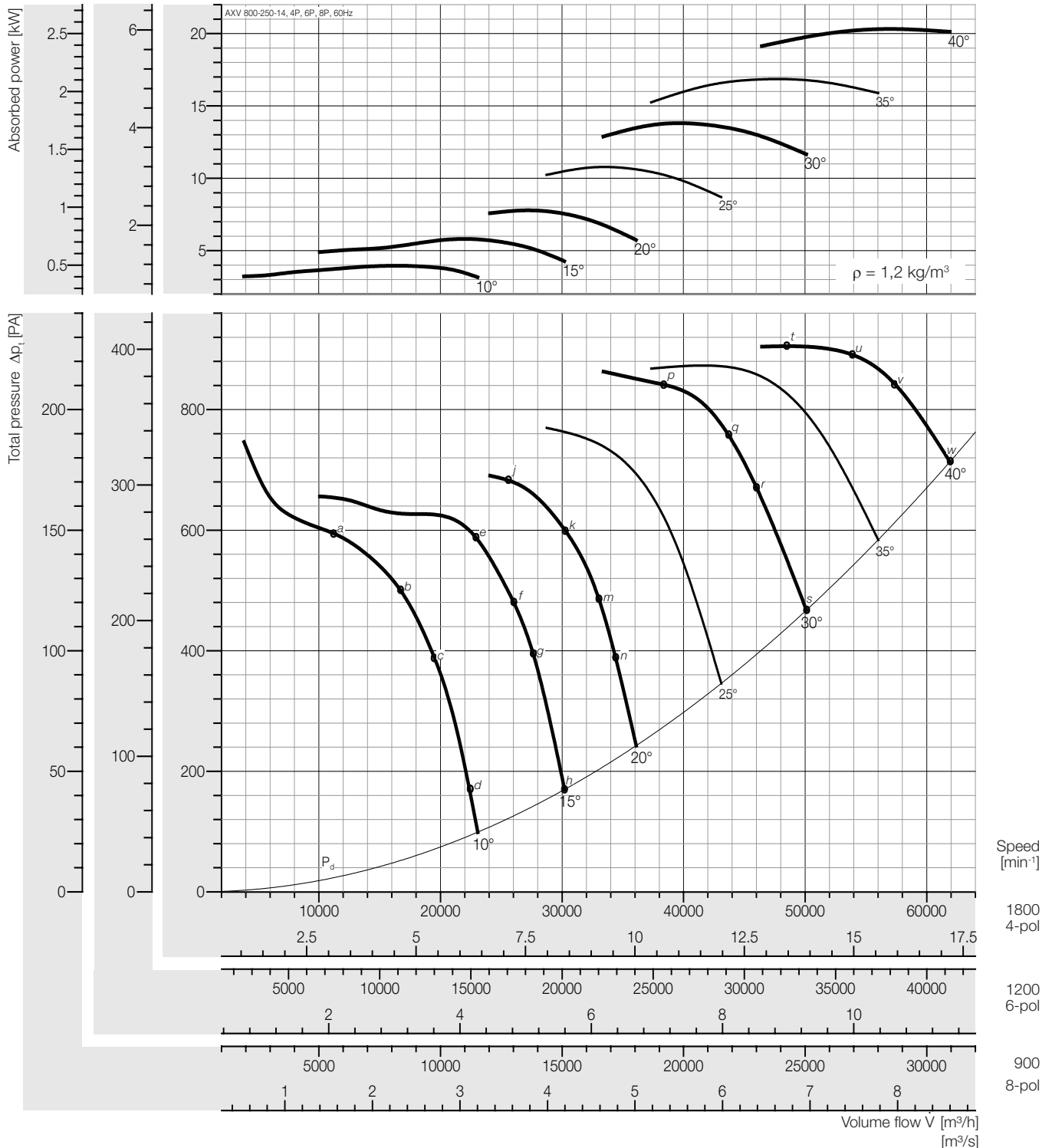

### Peak absorbed power [kW]

n [min <sup>-1</sup> ]	Pitch angle [°]						
	10	15	20	25	30	35	40
900	0,494	0,725	0,972	1,348	1,725	2,107	2,539
Motor	0,55	0,75	1,1	1,5	2,2		3,0
1200	1,172	1,717	2,305	3,195	4,088	4,994	6,019
Motor	1,5	2,2	3,0	4,0	5,5		7,5
1800	3,956	5,796	7,779	13,80	16,86	10,36	20,32
Motor	4,0	7,5	11	-			

### Sound power level, Lwi(A) [dB(A)]

Lwi(A)	a	b	c	d	e	f	g	h	j	k	m	n	p	q	r	s	t	u	v	w
4P	108	107	106	105	107	103	102	104	109	105	104	106	105	106	107	107	109	109	109	110
6P	96	97	96	95	97	93	92	94	98	94	93	95	94	95	95	96	96	97	97	98
8P	89	90	89	88	90	87	86	87	91	87	86	88	87	88	88	89	90	90	90	91

Plastic Duct

Lwi(A)	a	b	c	d	e	f	g	h	j	k	m	n	p	q	r	s	t	u	v	w
4P	106	105	104	103	105	101	100	102	107	103	102	104	103	104	105	105	107	107	107	108
6P	94	95	94	93	95	91	90	92	96	92	91	93	92	93	93	94	94	95	95	96
8P	87	88	87	86	88	85	84	85	89	85	84	86	85	86	86	87	88	88	88	89

\* Unlined Metal Duct

Fan test laboratory AMCA 210 Test Chamber. Performance certified is for installation type D - Ducted inlet, Ducted outlet. Performance ratings do not include the effects of appurtenances (accessories-belt cover, pulley & belt).

Dimensions + Accessories Page 191 - 194;  
Sound power frequency spectrum L<sub>w</sub>(f) Page 196 - 200.

The A-weighted sound ratings shown have been calculated per AMCA International Standard 301. Values shown are for inlet Lwi(A) sound power levels for installation Type D: ducted inlet, ducted outlet. Ratings include the effects of duct end correction.

\* Sound power level with unlined metal duct were obtained from the test in the reverberant room. Data are not licensed by AMCA.



# Performance Curve

AXV 900-250-7, 60 Hz

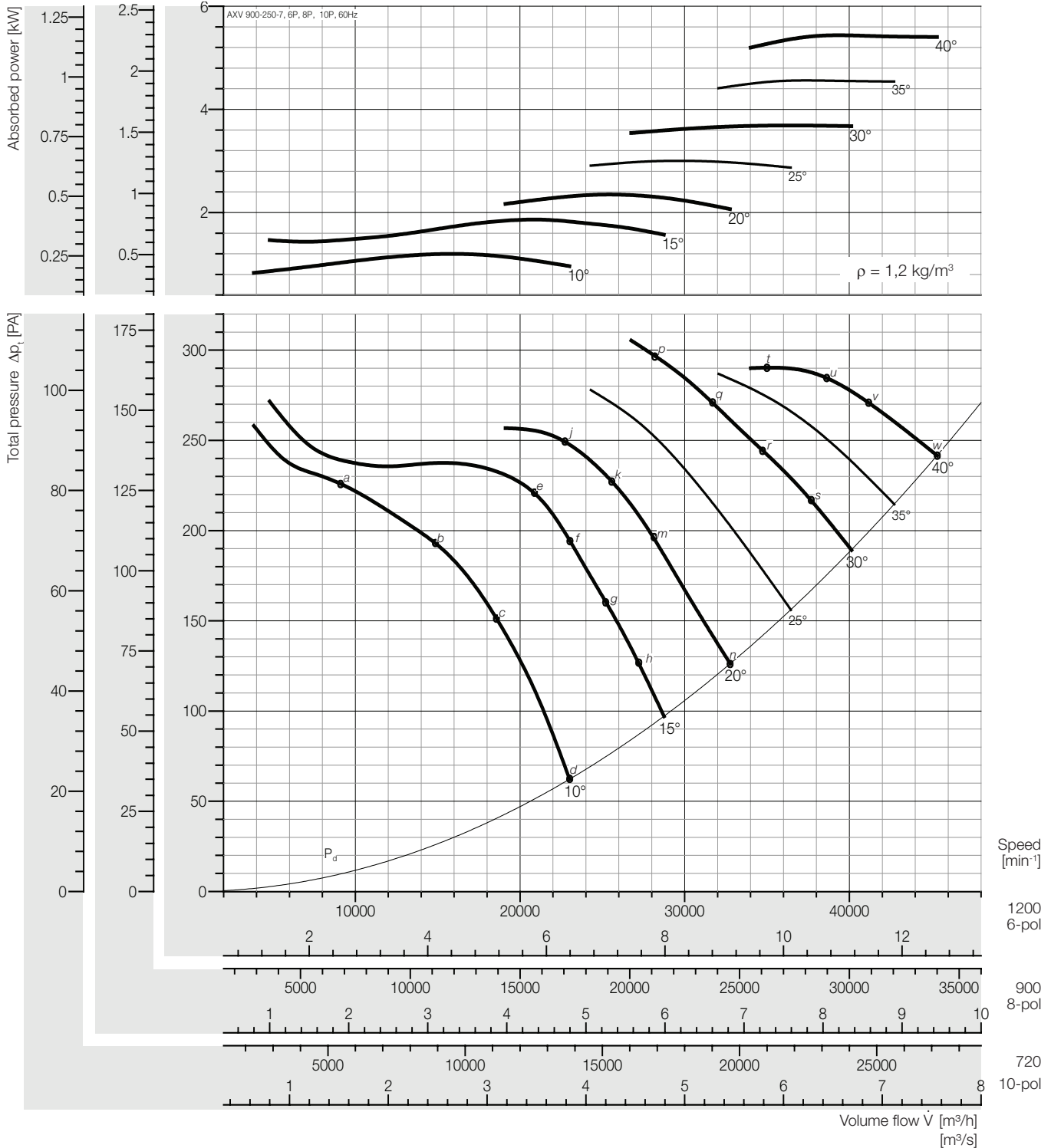

### Peak absorbed power [kW]

n [min <sup>-1</sup> ]	Pitch angle [°]						
	10	15	20	25	30	35	40
720	0,258	0,402	0,507	0,649	0,796	0,985	1,174
Motor	0,37	0,55	0,75	1,1	1,5	2,2	
900	0,504	0,786	0,991	1,267	1,555	1,924	2,293
Motor	0,55	1,1	1,5	2,2	3,0		
1200	1,195	1,863	2,348	3,002	3,687	4,560	5,436
Motor	1,5	2,2	3,0	4,0	5,5		

### Sound power level, Lwi(A) [dB(A)]

Lwi(A)	a	b	c	d	e	f	g	h	j	k	m	n	p	q	r	s	t	u	v	w
6P	96	98	94	90	94	91	90	90	93	91	90	91	95	94	94	94	100	96	95	95
8P	88	91	87	84	87	84	83	83	86	84	83	84	88	87	87	87	93	88	88	88
10P	82	85	81	79	81	79	78	78	81	79	78	79	82	82	82	81	87	83	82	83

Plastic Duct

Lwi(A)	a	b	c	d	e	f	g	h	j	k	m	n	p	q	r	s	t	u	v	w
6P	94	96	92	88	92	89	88	88	91	89	88	89	93	92	92	92	98	94	93	93
8P	86	89	85	82	85	82	81	81	84	82	81	82	86	85	85	85	91	86	86	86
10P	80	83	79	77	79	77	76	76	79	77	76	77	80	80	80	79	85	81	80	81

\* Unlined Metal Duct

Fan test laboratory AMCA 210 Test Chamber. Performance certified is for installation type D - Ducted inlet, Ducted outlet. Performance ratings do not include the effects of appurtenances (accessories-belt cover, pulley & belt).

Dimensions + Accessories Page 191 - 194;  
Sound power frequency spectrum L<sub>w</sub>(A) Page 196 - 200.

The A-weighted sound ratings shown have been calculated per AMCA International Standard 301. Values shown are for inlet Lwi(A) sound power levels for installation Type D: ducted inlet, ducted outlet. Ratings include the effects of duct end correction.

\* Sound power level with unlined metal duct were obtained from the test in the reverberant room. Data are not licensed by AMCA.



# Performance Curve

AXV 900-250-14, 60 Hz

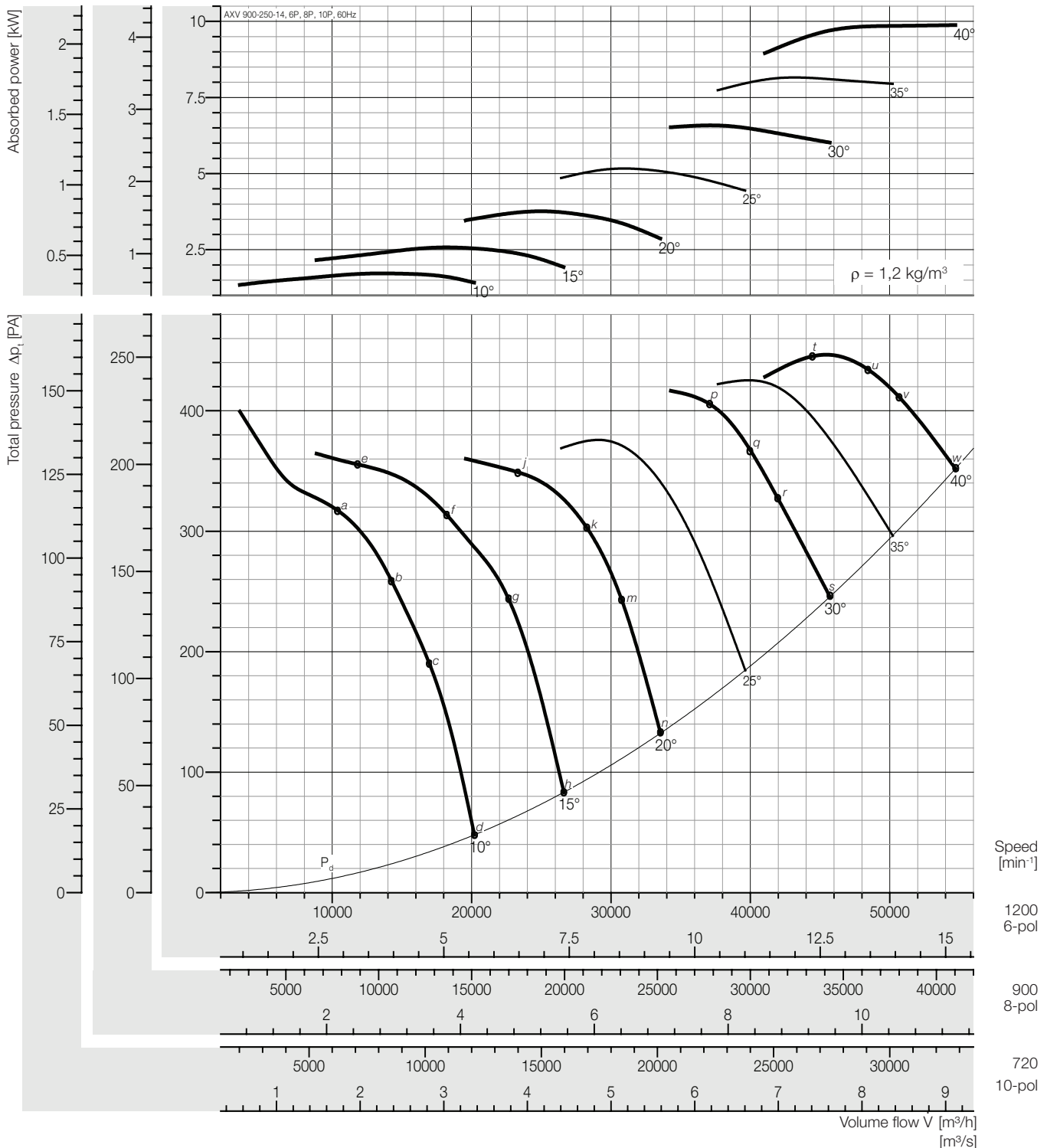

### Peak absorbed power [kW]

n [min <sup>-1</sup> ]	Pitch angle [°]						
	10	15	20	25	30	35	40
720	0,370	0,555	0,811	1,116	1,422	1,762	2,134
Motor	0,37	0,75	1,1	1,5		2,2	
900	0,724	1,085	1,583	2,179	2,777	3,441	4,168
Motor	0,75	1,1	2,2		3,0	4,0	5,5
1200	1,715	2,572	3,753	5,166	6,583	8,157	9,879
Motor	2,2	3,0	4,0	5,5	7,5	11	

### Sound power level, Lwi(A) [dB(A)]

Lwi(A)	a	b	c	d	e	f	g	h	j	k	m	n	p	q	r	s	t	u	v	w
6P	98	100	99	97	99	102	98	96	102	96	94	95	95	95	95	96	96	96	97	98
8P	91	93	92	90	92	94	91	89	95	89	88	89	89	88	88	89	90	89	90	91
10P	85	87	87	85	85	88	86	84	89	84	83	84	83	82	82	83	84	84	84	85

Plastic Duct

Lwi(A)	a	b	c	d	e	f	g	h	j	k	m	n	p	q	r	s	t	u	v	w
6P	96	98	97	95	97	100	96	94	100	94	92	93	93	93	93	94	94	94	95	96
8P	89	91	90	88	90	92	89	87	93	87	87	87	87	86	86	87	88	87	88	89
10P	83	85	85	83	83	83	83	82	87	82	81	82	81	80	80	81	82	82	82	83

\* Unlined Metal Duct

Fan test laboratory AMCA 210 Test Chamber. Performance certified is for installation type D - Ducted inlet, Ducted outlet. Performance ratings do not include the effects of appurtenances (accessories-belt cover, pulley & belt).

Dimensions + Accessories Page 191 - 194;  
Sound power frequency spectrum L<sub>w</sub> Page 196 - 200.

The A-weighted sound ratings shown have been calculated per AMCA International Standard 301. Values shown are for inlet Lwi(A) sound power levels for installation Type D: ducted inlet, ducted outlet. Ratings include the effects of duct end correction.

\* Sound power level with unlined metal duct were obtained from the test in the reverberant room. Data are not licensed by AMCA.





# Performance Curve

AXV 900-300-10, 60 Hz

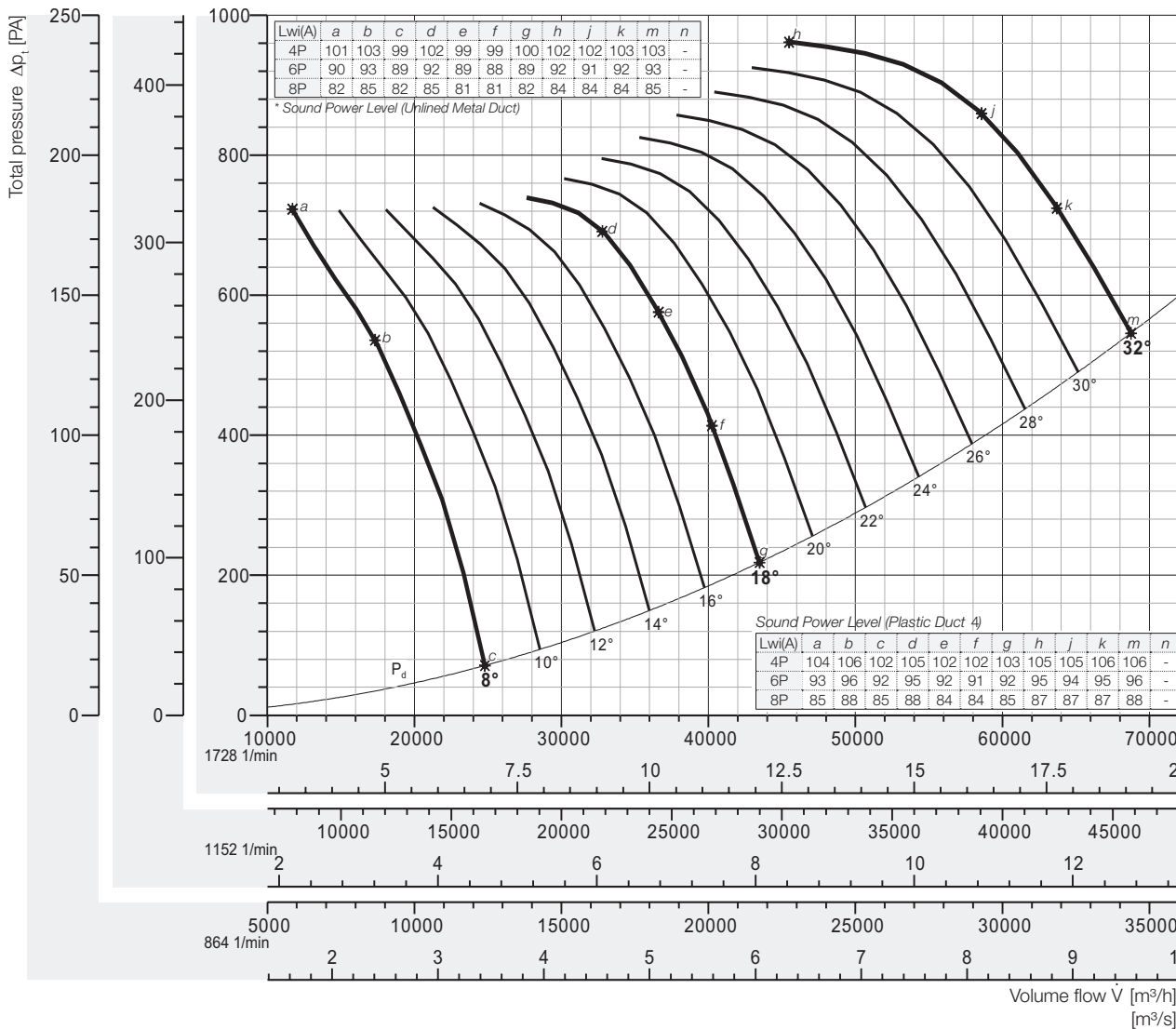
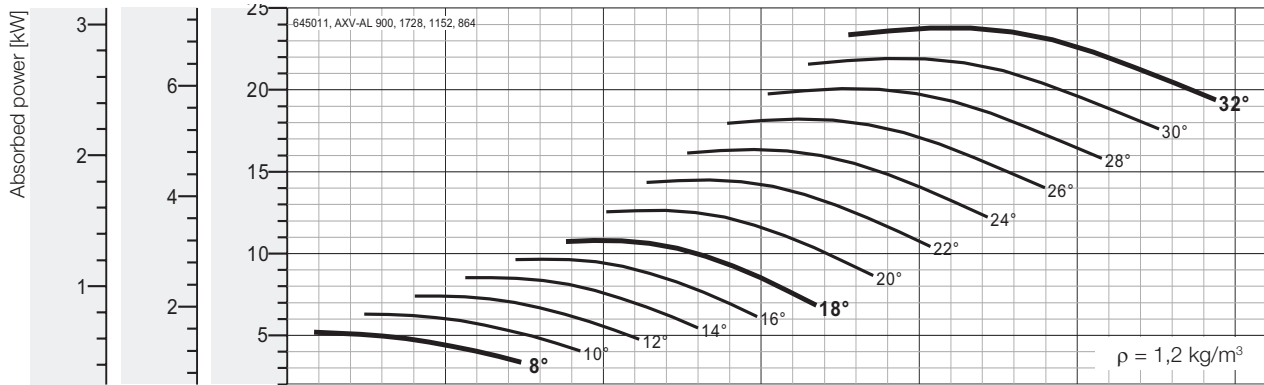

Speed [min<sup>-1</sup>]  
 1728 4-pol  
 1152 6-pol  
 864 8-pol

## Peak absorbed power [kW]

\* Out of Range

n [min <sup>-1</sup> ]	Pitch angle [°]																
	8	10	12	14	16	18	20	22	24	26	28	30	32	34	36	38	40
864 motor	0,649	0,787	0,926	1,07	1,21	1,35	1,58	1,81	2,04	2,28	2,51	2,74	2,97	-	-	-	-
1152 motor	1,54	1,87	2,19	2,53	2,86	3,20	3,74	4,29	4,84	5,39	5,95	6,50	7,05	-	-	-	-
1728 motor	5,19	6,30	7,41	8,53	9,66	10,8	12,6	14,5	16,3	18,2	20,1	21,9	23,8	-	-	-	-

Fan test laboratory AMCA 210 Test Chamber. Performance certified is for installation type D - Ducted inlet, Ducted outlet. Performance ratings do not include the effects of appurtenances (accessories-belt cover, pulley & belt).

Dimensions + Accessories Page 191 ~ 194;  
 Sound power frequency spectrum L<sub>w,dB</sub> Page 196 ~ 200.

The A-weighted sound ratings shown have been calculated per AMCA International Standard 301. Values shown are for inlet Lw(A) sound power levels for installation Type D: ducted inlet, ducted outlet. Ratings include the effects of duct end correction.

\* Sound power level with unlined metal duct were obtained from the test in the reverberant room. Data are not licensed by AMCA.



# Performance Curve

AXV 1000-250-7, 6P, 8P, 10P, 60Hz

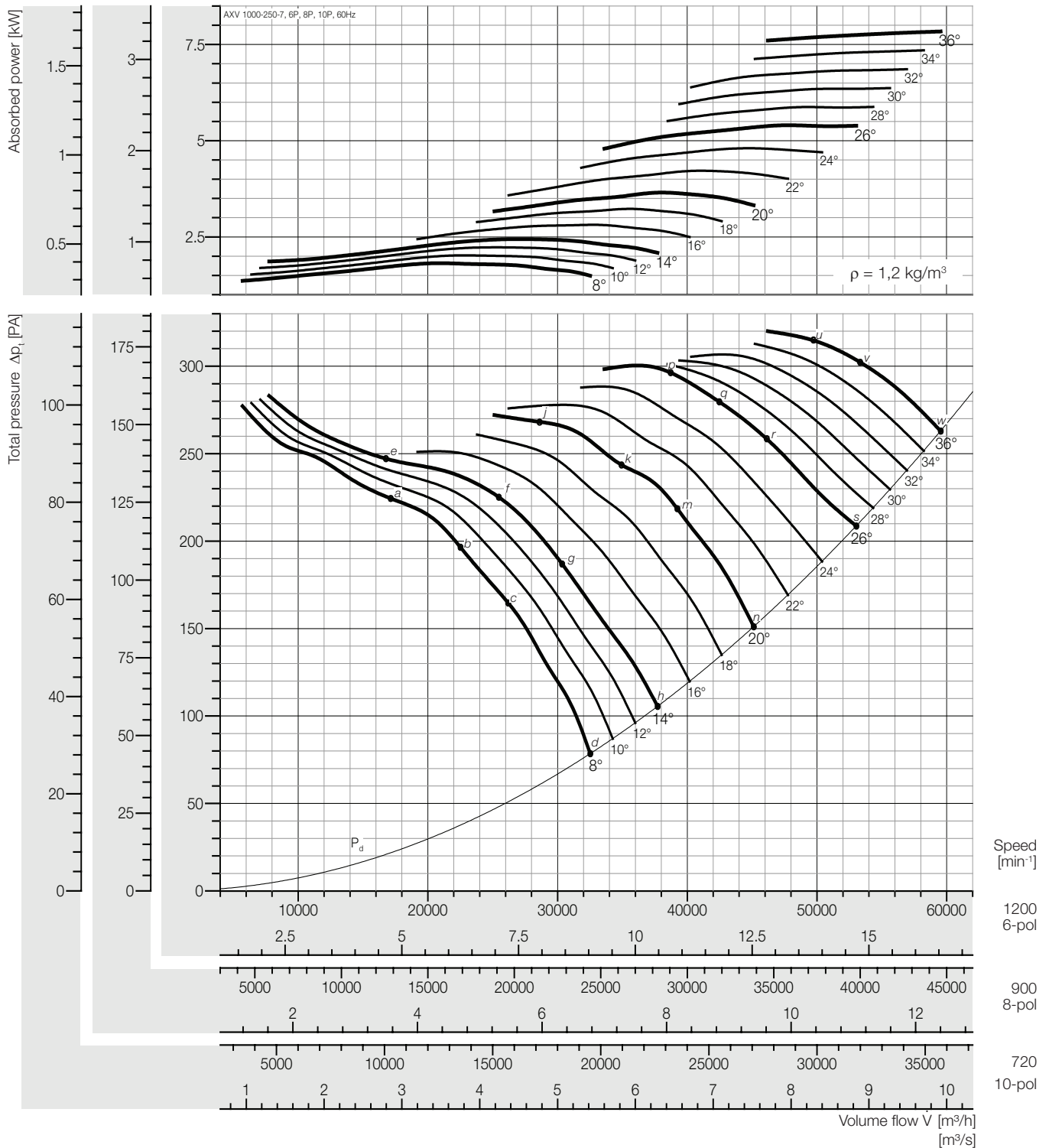

### Peak absorbed power [kW]

n [min <sup>-1</sup> ]	Pitch angle [°]														
	8	10	12	14	16	18	20	22	24	26	28	30	32	34	36
720	0,39	0,44	0,48	0,53	0,61	0,70	0,79	0,91	1,04	1,17	1,27	1,38	1,48	1,59	1,69
Motor	0,55				0,75		1,1			1,5				2,2	
900	0,77	0,85	0,94	1,03	1,19	1,36	1,54	1,78	2,03	2,28	2,48	2,69	2,89	3,10	3,31
Motor	1,1				1,5		2,2			3,0				4,0	
1200	1,82	2,02	2,23	2,44	2,81	3,22	3,65	4,22	4,80	5,40	5,88	6,37	6,86	7,35	7,84
Motor	2,2		3,0		4,0		5,5			7,5				11	

### Sound power level, Lwi(A) [dB(A)]

Lwi(A)	a	b	c	d	e	f	g	h	j	k	m	n	p	q	r	s	t	u	v	w
6P	99	100	99	92	100	102	100	92	104	101	97	93	101	96	96	95	-	97	96	97
8P	92	92	92	85	92	94	93	86	96	94	90	86	94	89	89	88	-	90	89	90
10P	86	87	87	80	86	89	88	81	90	88	85	81	88	84	84	83	-	84	83	85
Plastic Duct																				
Lwi(A)	a	b	c	d	e	f	g	h	j	k	m	n	p	q	r	s	t	u	v	w
6P	97	98	97	90	98	100	98	90	102	99	95	91	99	94	94	93	-	95	94	95
8P	90	90	90	83	90	92	91	84	94	92	88	84	92	87	87	86	-	88	87	88
10P	84	85	85	78	84	87	86	79	88	86	83	79	86	82	82	81	-	82	81	83
* Unlined Metal Duct																				

Fan test laboratory AMCA 210 Test Chamber. Performance certified is for installation type D - Ducted inlet, Ducted outlet. Performance ratings do not include the effects of appurtenances (accessories-belt cover, pulley & belt).

Dimensions + Accessories Page 191 - 194;  
Sound power frequency spectrum L<sub>w</sub> Page 196 - 200.

The A-weighted sound ratings shown have been calculated per AMCA International Standard 301. Values shown are for inlet LwiA sound power levels for installation Type D: ducted inlet, ducted outlet. Ratings include the effects of duct end correction.

\* Sound power level with unlined metal duct were obtained from the test in the reverberant room. Data are not licensed by AMCA.



# Performance Curve

AXV 1000-250-14, 60 Hz

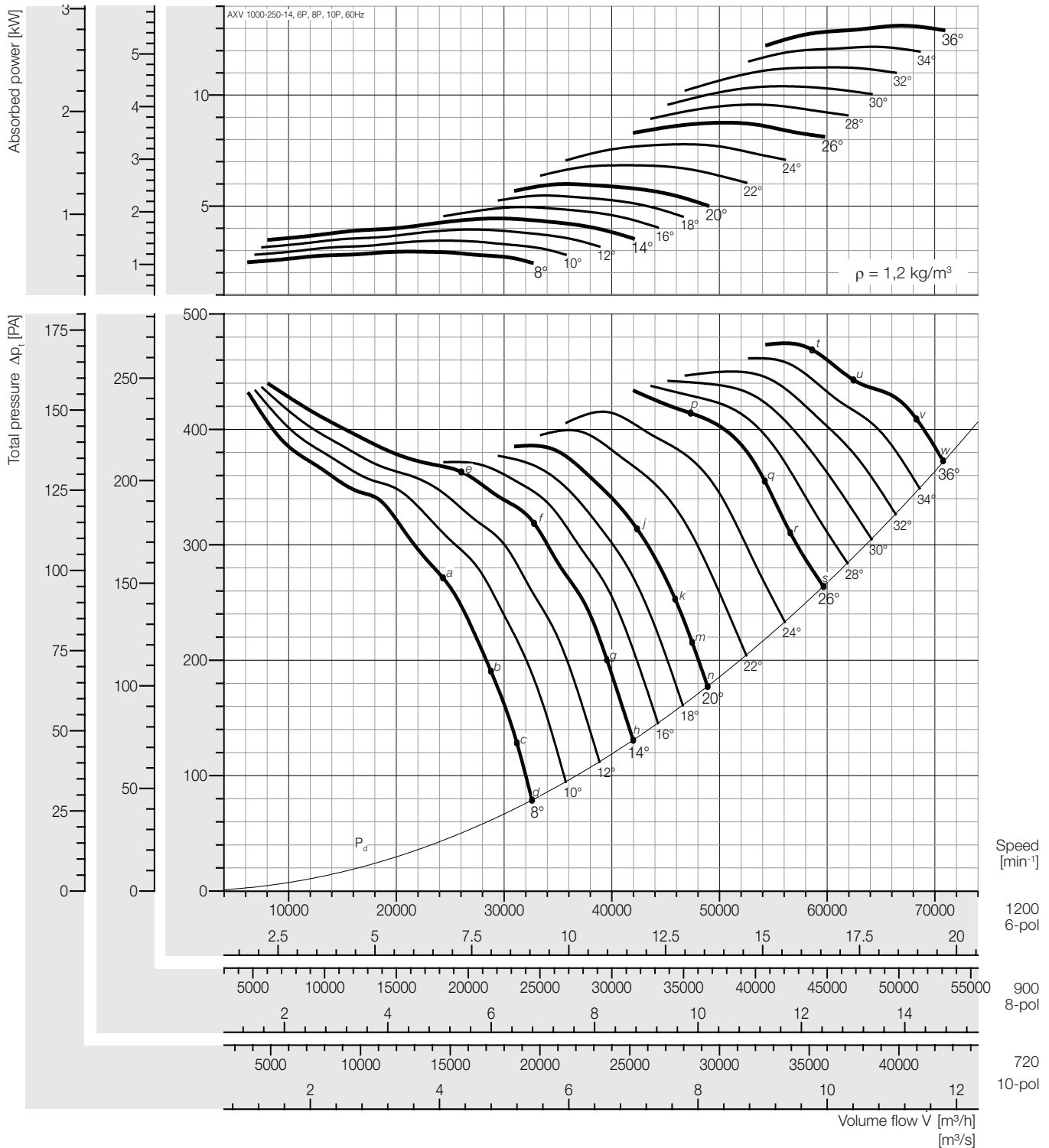

### Peak absorbed power [kW]

n [min <sup>-1</sup> ]	Pitch angle [°]														
	8	10	12	14	16	18	20	22	24	26	28	30	32	34	36
720	0,64	0,74	0,85	0,96	1,07	1,18	1,29	1,48	1,68	1,89	2,07	2,25	2,43	2,63	2,83
Motor	0,75	1,1			1,5			2,2			3,0				
900	1,24	1,45	1,66	1,87	2,09	2,31	2,53	2,88	3,28	3,69	4,04	4,39	4,74	5,13	5,54
Motor	1,5	2,2			3,0			4,0			5,5			7,5	
1200	2,95	3,43	3,93	4,43	4,95	5,47	5,99	6,84	7,78	8,75	9,57	10,4	11,2	12,2	13,1
Motor	3,0	4,0			5,5			7,5			11				

### Sound power level, Lwi(A) [dB(A)]

Lwi(A)	a	b	c	d	e	f	g	h	j	k	m	n	p	q	r	s	t	u	v	w
6P	103	101	97	96	102	104	96	95	101	97	96	96	104	99	98	97	101	100	99	99
8P	96	94	90	90	95	97	90	88	94	91	89	89	97	92	91	90	94	93	92	92
10P	90	89	85	85	89	91	84	83	89	85	84	84	91	86	85	85	88	87	86	87
Plastic Duct																				
Lwi(A)	a	b	c	d	e	f	g	h	j	k	m	n	p	q	r	s	t	u	v	w
6P	101	99	95	94	100	102	94	93	99	95	94	94	102	97	96	95	99	98	97	97
8P	94	92	88	88	93	95	88	86	92	89	87	87	95	90	89	88	92	91	90	90
10P	88	87	83	83	87	89	82	81	87	83	82	82	89	84	83	83	86	85	84	85
* Unlined Metal Duct																				

Fan test laboratory AMCA 210 Test Chamber. Performance certified is for installation type D - Ducted inlet, Ducted outlet. Performance ratings do not include the effects of appurtenances (accessories-belt cover, pulley & belt).

Dimensions + Accessories Page 191 - 194;  
Sound power frequency spectrum L<sub>w</sub>(A) Page 196 - 200.

The A-weighted sound ratings shown have been calculated per AMCA International Standard 301. Values shown are for inlet Lwi(A) sound power levels for installation Type D: ducted inlet, ducted outlet. Ratings include the effects of duct end correction.

\* Sound power level with unlined metal duct were obtained from the test in the reverberant room. Data are not licensed by AMCA.



# Performance Curve

AXV 1000-300-10, 60 Hz

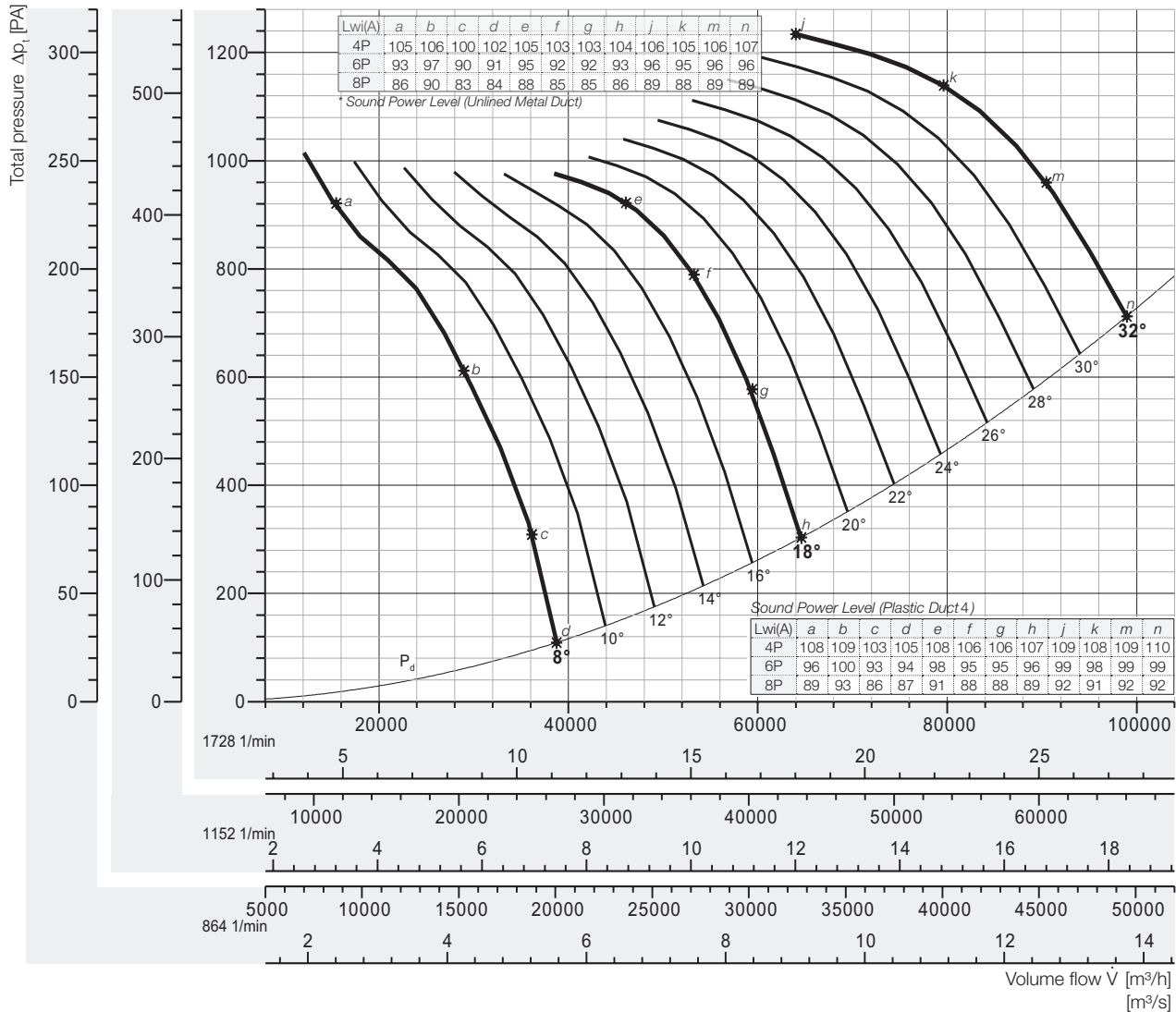
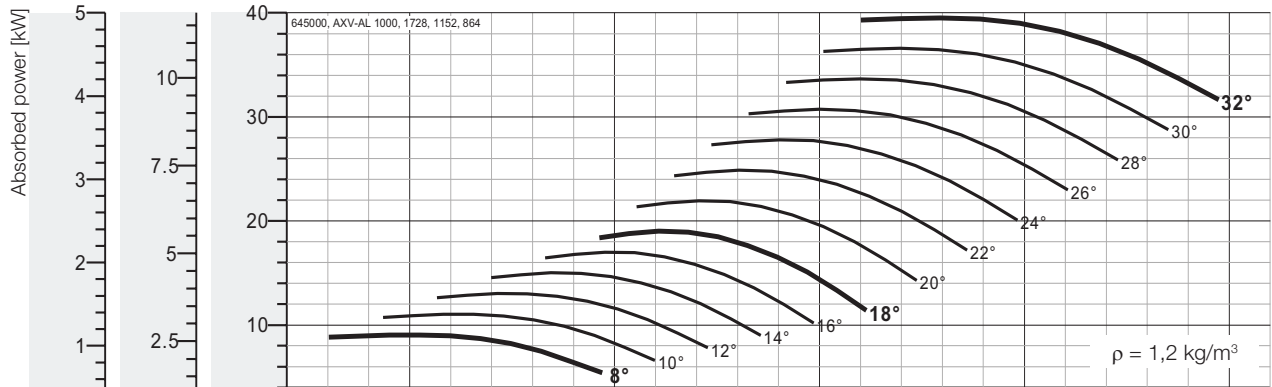

## Peak absorbed power [kW]

n [min <sup>-1</sup> ]	Pitch angle [°]																
	8	10	12	14	16	18	20	22	24	26	28	30	32	34	36	38	40
864 motor	1,13	1,38	1,63	1,88	2,13	2,38	2,74	3,11	3,47	3,84	4,21	4,57	4,94	-	-	-	-
	1,5		2,2			3		4			5,5						
1152 motor	2,68	3,27	3,86	4,45	5,04	5,63	6,50	7,37	8,24	9,10	9,97	10,8	11,7	-	-	-	-
	3	4		5,5		7,5		11			15						
1728 motor	9,05	11,0	13,0	15,0	17,0	19,0	21,9	24,9	27,8	30,7	33,7	36,6	39,5	-	-	-	-
	11		15		18,5	22		30		37		45					

Fan test laboratory AMCA 210 Test Chamber. Performance certified is for installation type D - Ducted inlet, Ducted outlet. Performance ratings do not include the effects of appurtenances (accessories-belt cover, pulley & belt).

Dimensions + Accessories Page 191 - 194;  
Sound power frequency spectrum L<sub>w</sub> Page 196 - 200.

The A-weighted sound ratings shown have been calculated per AMCA International Standard 301. Values shown are for inlet Lw(A) sound power levels for installation Type D: ducted inlet, ducted outlet. Ratings include the effects of duct end correction.

\* Sound power level with unlined metal duct were obtained from the test in the reverberant room. Data are not licensed by AMCA.

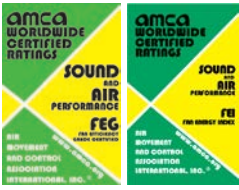

# Performance Curve

AXV 1120-300-5, 60 Hz

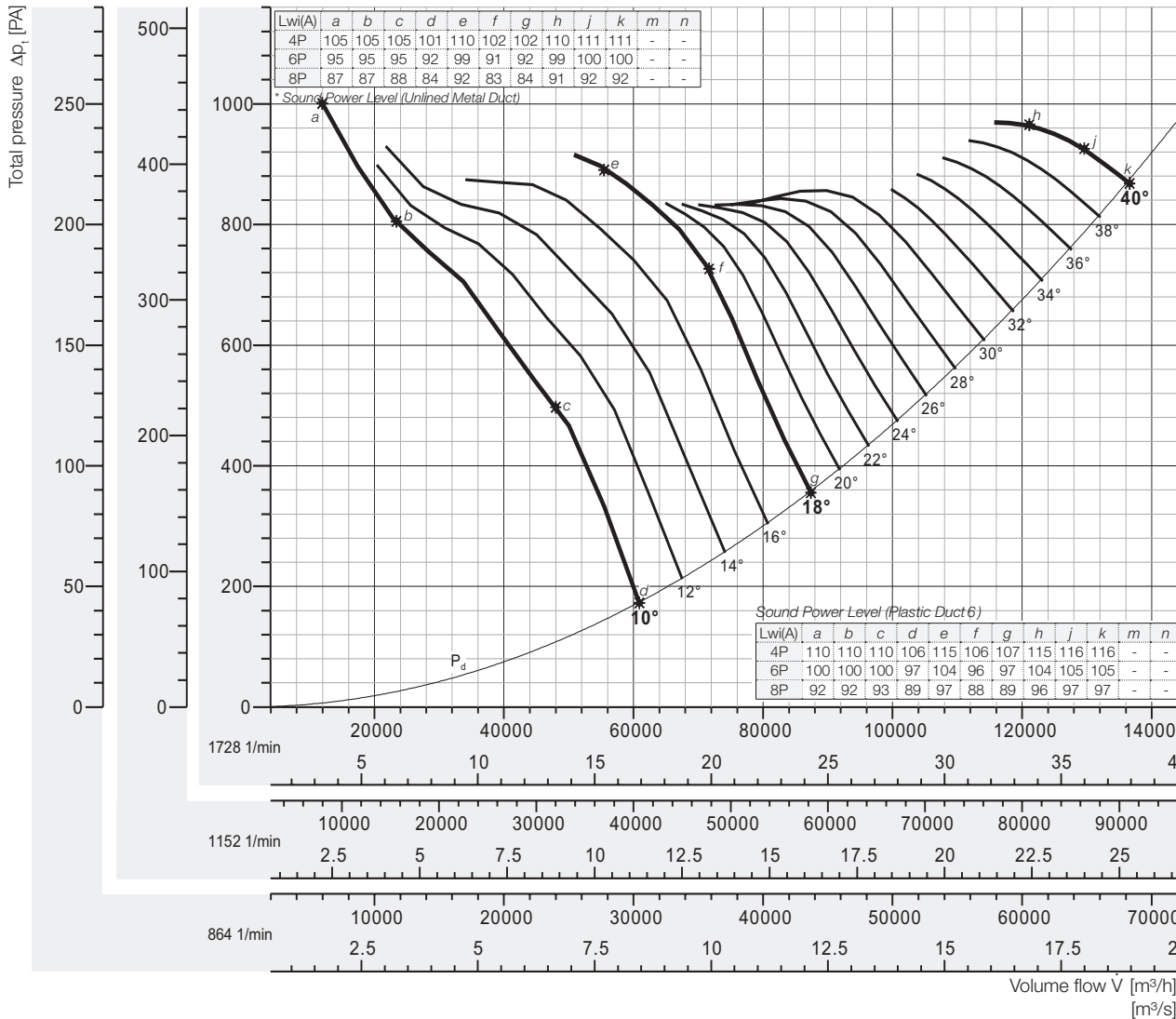
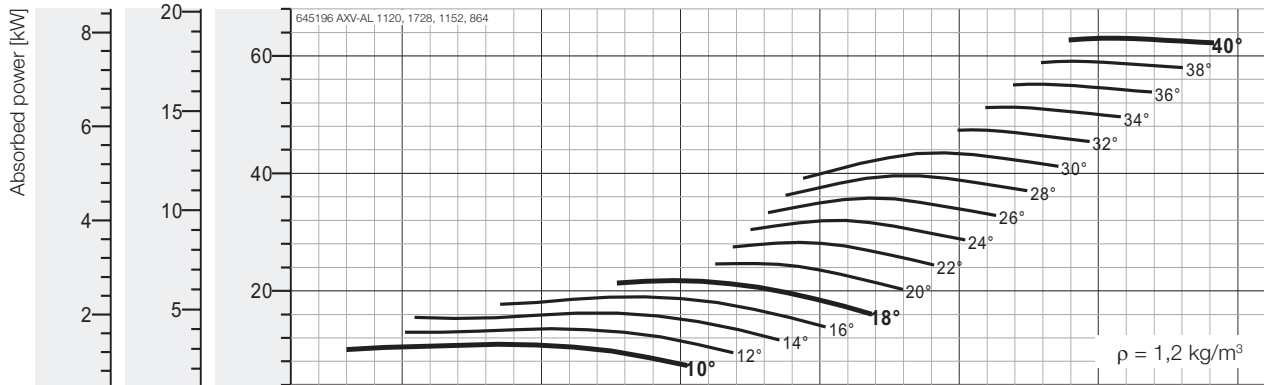

Speed [min<sup>-1</sup>]  
 1728 4-pol  
 1152 6-pol  
 864 8-pol

## Peak absorbed power [kW]

n [min <sup>-1</sup> ]	Pitch angle [°]																
	8	10	12	14	16	18	20	22	24	26	28	30	32	34	36	38	40
864 motor	-	1,36	1,70	2,03	2,37	2,72	3,08	3,53	4,00	4,48	4,95	5,44	5,93	6,41	6,90	7,39	7,88
1152 motor	-	3,23	4,02	4,81	5,62	6,44	7,31	8,37	9,48	10,6	11,7	12,9	14,0	15,2	16,3	17,5	18,7
1728 motor	-	10,9	13,6	16,2	19,0	21,7	24,7	28,3	32,0	35,8	39,6	43,5	47,4	51,3	55,2	59,1	63,0

Fan test laboratory AMCA 210 Test Chamber. Performance certified is for installation type D - Ducted inlet, Ducted outlet. Performance ratings do not include the effects of appurtenances (accessories-belt cover, pulley & belt).

Dimensions + Accessories Page 191 ~ 194;  
 Sound power frequency spectrum L<sub>w</sub> Page 196 ~ 200.

The A-weighted sound ratings shown have been calculated per AMCA International Standard 301. Values shown are for inlet Lw<sub>i</sub> sound power levels for installation Type D: ducted inlet, ducted outlet. Ratings include the effects of duct end correction.

\* Sound power level with unlined metal duct were obtained from the test in the reverberant room. Data are not licensed by AMCA.



# Performance Curve

AXV 1250-370-6, 60 Hz

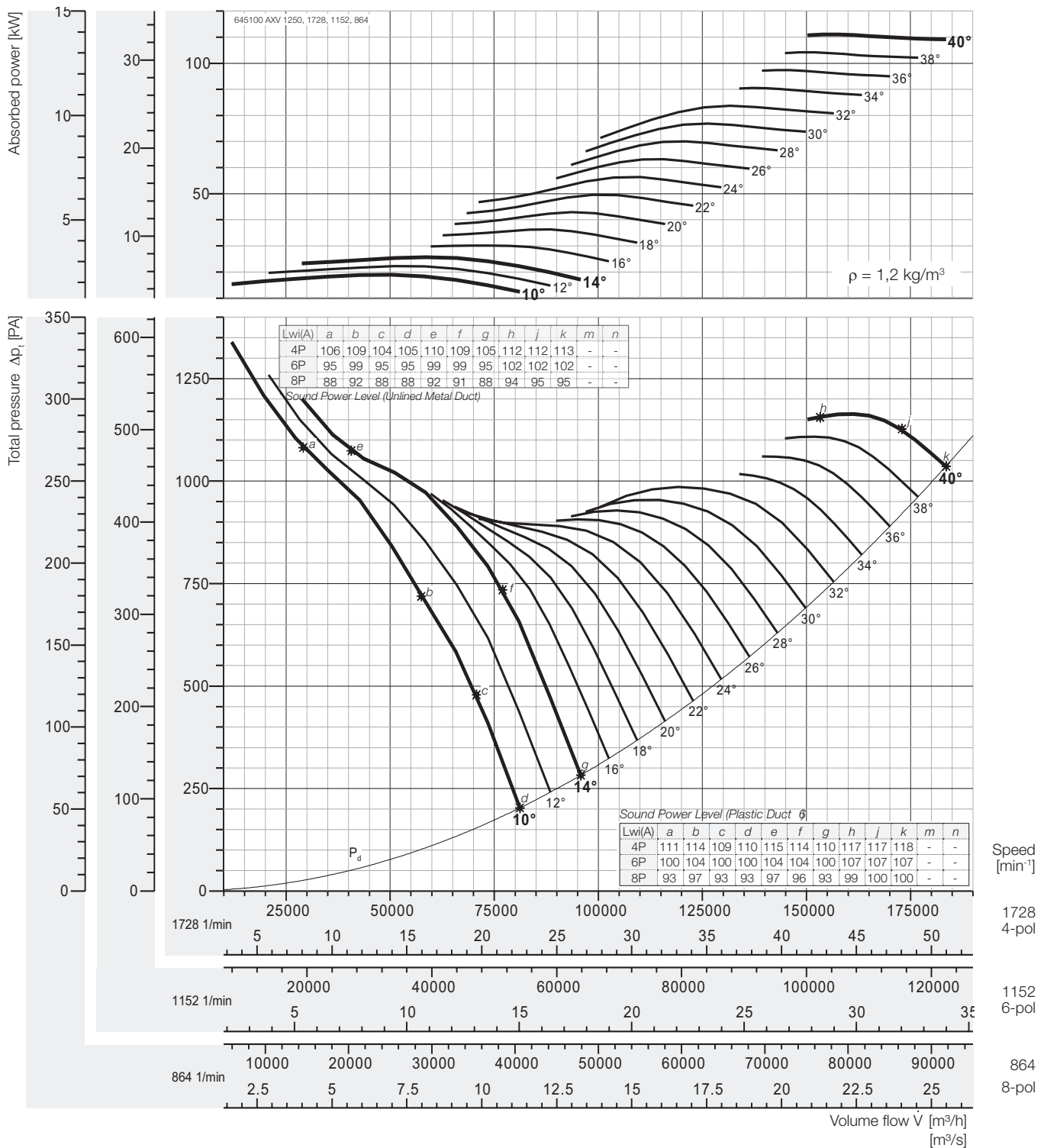

## Peak absorbed power [kW]

n [min <sup>-1</sup> ]	Pitch angle [°]																
	8	10	12	14	16	18	20	22	24	26	28	30	32	34	36	38	40
864 motor	-	2,38	2,79	3,21	3,77	4,54	5,37	6,20	7,05	7,90	8,76	9,62	10,5	11,3	12,2	13,0	13,7
		3		4		5,5		7,5		11				15			
1152 motor	-	5,63	6,60	7,60	8,93	10,8	12,7	14,7	16,7	18,7	20,8	22,8	24,8	26,8	28,9	30,9	32,5
		7,5		11			15		18,5	22		30				37	
1728 motor	-	19,0	22,3	25,7	30,2	36,3	43,0	49,6	56,4	63,2	70,1	76,9	83,8	90,6	97,4	104,2	109,6
		22	30		37		45	55	75			90		110			

Fan test laboratory AMCA 210 Test Chamber. Performance certified is for installation type D - Ducted inlet, Ducted outlet. Performance ratings do not include the effects of appurtenances (accessories-belt cover, pulley & belt).

Dimensions + Accessories Page 191 - 194;  
Sound power frequency spectrum  $L_{wne}$  Page 196 - 200.

The A-weighted sound ratings shown have been calculated per AMCA International Standard 301. Values shown are for inlet LwiA sound power levels for installation Type D: ducted inlet, ducted outlet. Ratings include the effects of duct end correction.

\* Sound power level with unlined metal duct were obtained from the test in the reverberant room. Data are not licensed by AMCA.



# Performance Curve

AXV 1400-420-6, 60 Hz

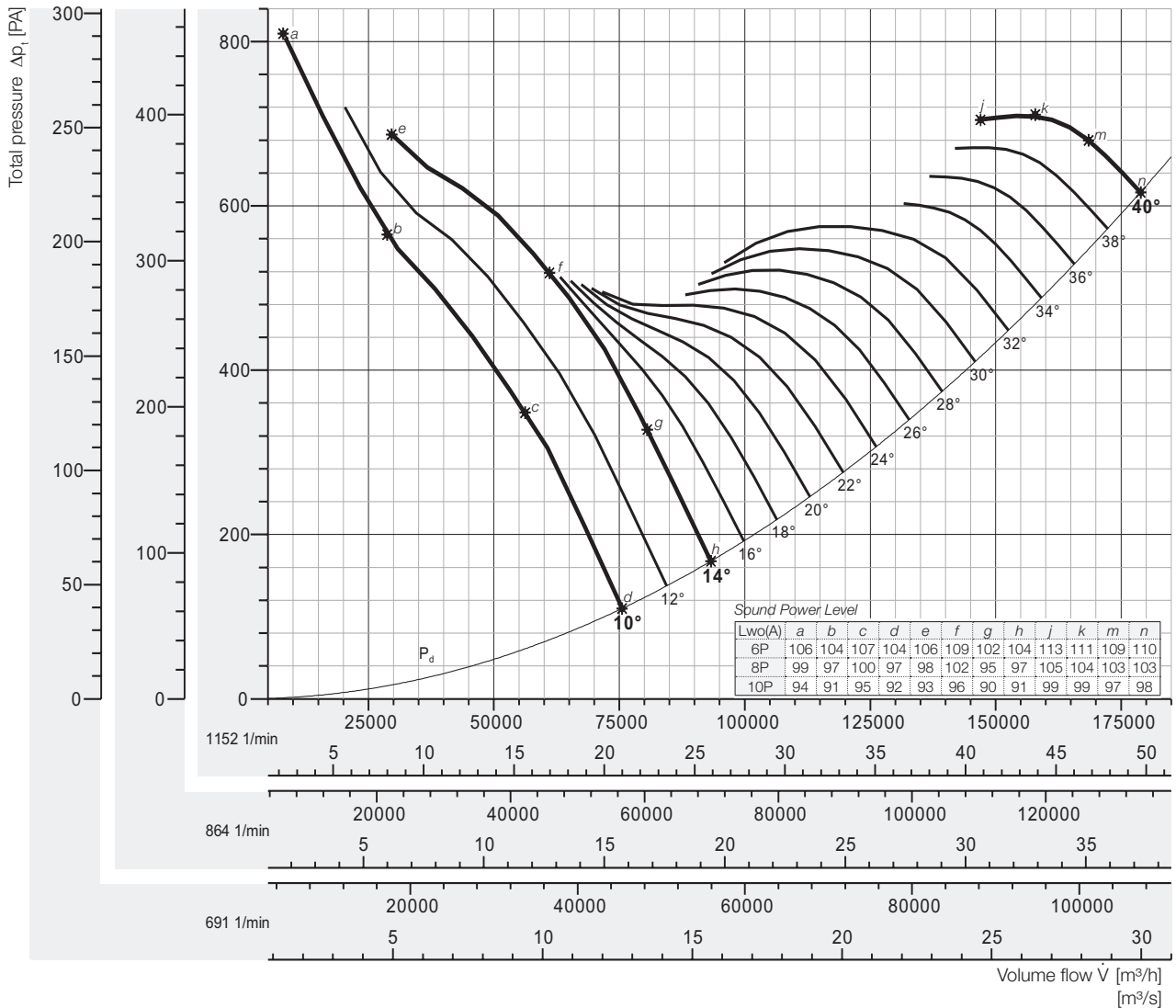
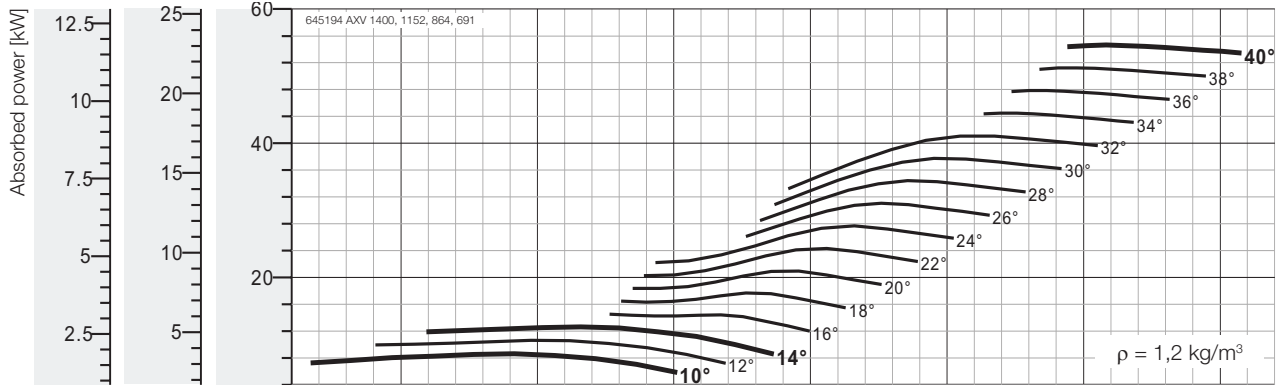

## Peak absorbed power [kW]

n [min <sup>-1</sup> ]	Pitch angle [°]																
	8	10	12	14	16	18	20	22	24	26	28	30	32	34	36	38	40
691 motor	-	1,86	2,29	2,73	3,13	3,81	4,52	5,25	5,98	6,70	7,42	8,15	8,86	9,60	10,3	11,0	11,8
		2,2	3		4		5,5		7,5			11					15
864 motor	-	3,63	4,47	5,33	6,13	7,45	8,84	10,3	11,7	13,1	14,5	15,9	17,3	18,8	20,2	21,6	23,0
		4	5,5		7,5		11		15			18,5		22			30
1152 motor	-	8,60	10,6	12,6	14,5	17,6	20,9	24,3	27,7	31,1	34,4	37,7	41,1	44,5	47,9	51,2	54,6
		11		15		18,5	22	30		37		45			55		

Fan test laboratory AMCA 210 Test Chamber. Performance certified is for installation type A - Free inlet, Free outlet. Performance ratings do not include the effects of appurtenances (accessories-belt cover, pulley & belt).

The A-weighted sound ratings shown have been calculated per AMCA International Standard 301. Values shown are for outlet LwoA sound power levels for installation Type A: free inlet, free outlet.

Dimensions + Accessories Page 191 - 194;  
Sound power frequency spectrum L<sub>max</sub> Page 196 - 200.



# Performance Curve

AXV 1600-420-6, 60 Hz

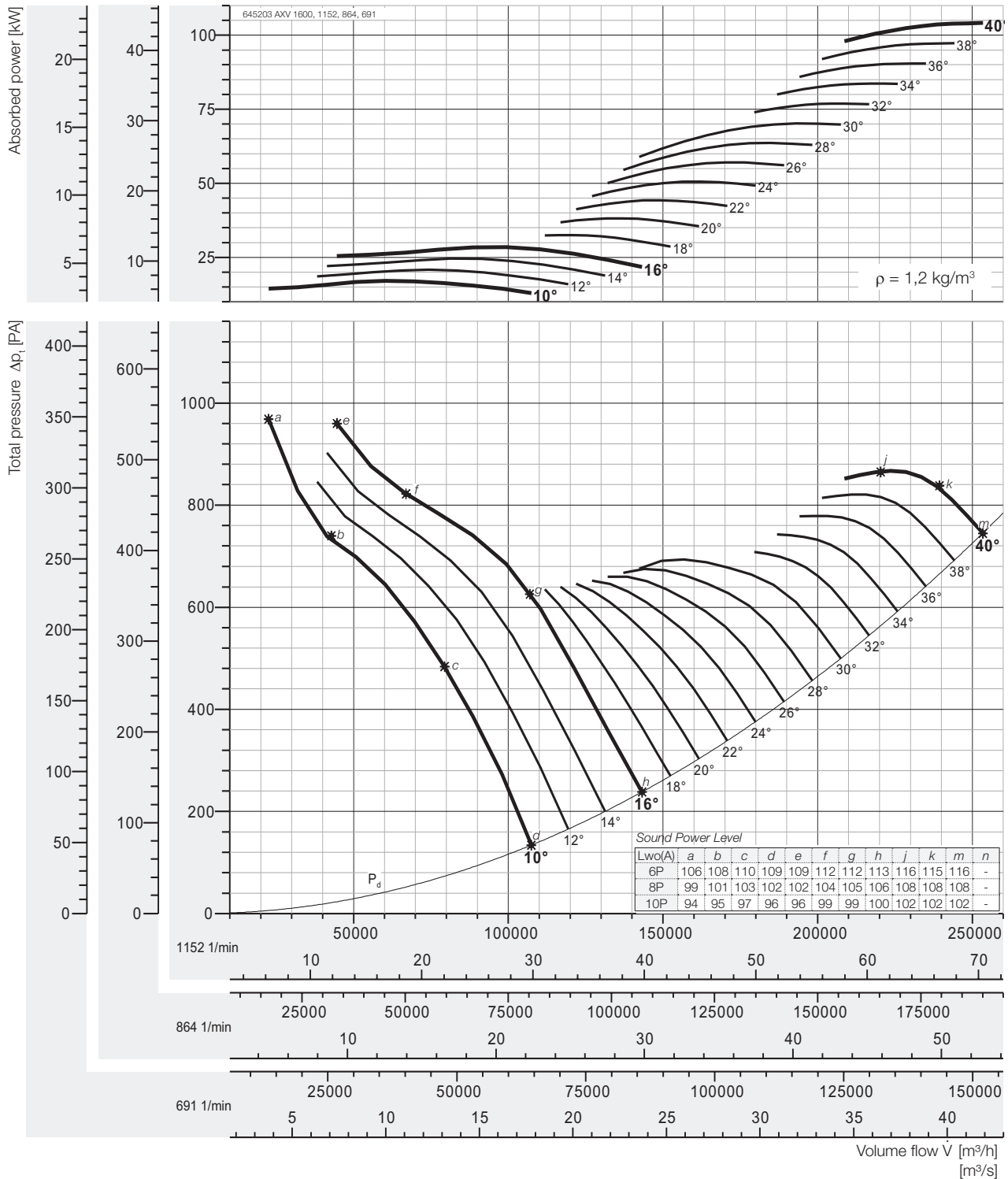

## Peak absorbed power [kW]

n [min <sup>-1</sup> ]	Pitch angle [°]																
	8	10	12	14	16	18	20	22	24	26	28	30	32	34	36	38	40
691 motor	-	3,68	4,49	5,31	6,13	7,02	8,24	9,55	10,9	12,3	13,7	15,2	16,6	18,1	19,5	21,0	22,5
		4	5,5		7,5		11			15		18,5		22		30	
864 motor	-	7,19	8,77	10,4	12,0	13,7	16,1	18,5	21,3	24,1	26,8	29,6	32,4	35,3	38,1	41,0	43,9
		7,5	11		15		18,5		22	30		37		45			
1152 motor	-	17,0	20,8	24,6	28,4	32,5	38,2	44,3	50,6	57,0	63,6	70,2	76,9	83,6	90,4	97,3	104,1
		18,5	22	30		37	45		55	75		90		110			

Fan test laboratory AMCA 210 Test Chamber. Performance certified is for installation type A - Free inlet, Free outlet. Performance ratings do not include the effects of appurtenances (accessories-belt cover, pulley & belt).

The A-weighted sound ratings shown have been calculated per AMCA International Standard 301. Values shown are for outlet L<sub>wa</sub> sound power levels for installation Type A: free inlet, free outlet.

Dimensions + Accessories Page 191 - 194;  
Sound power frequency spectrum L<sub>wa</sub> Page 196 - 200.





# Performance Curve

AXV 1800-540-6, 60 Hz

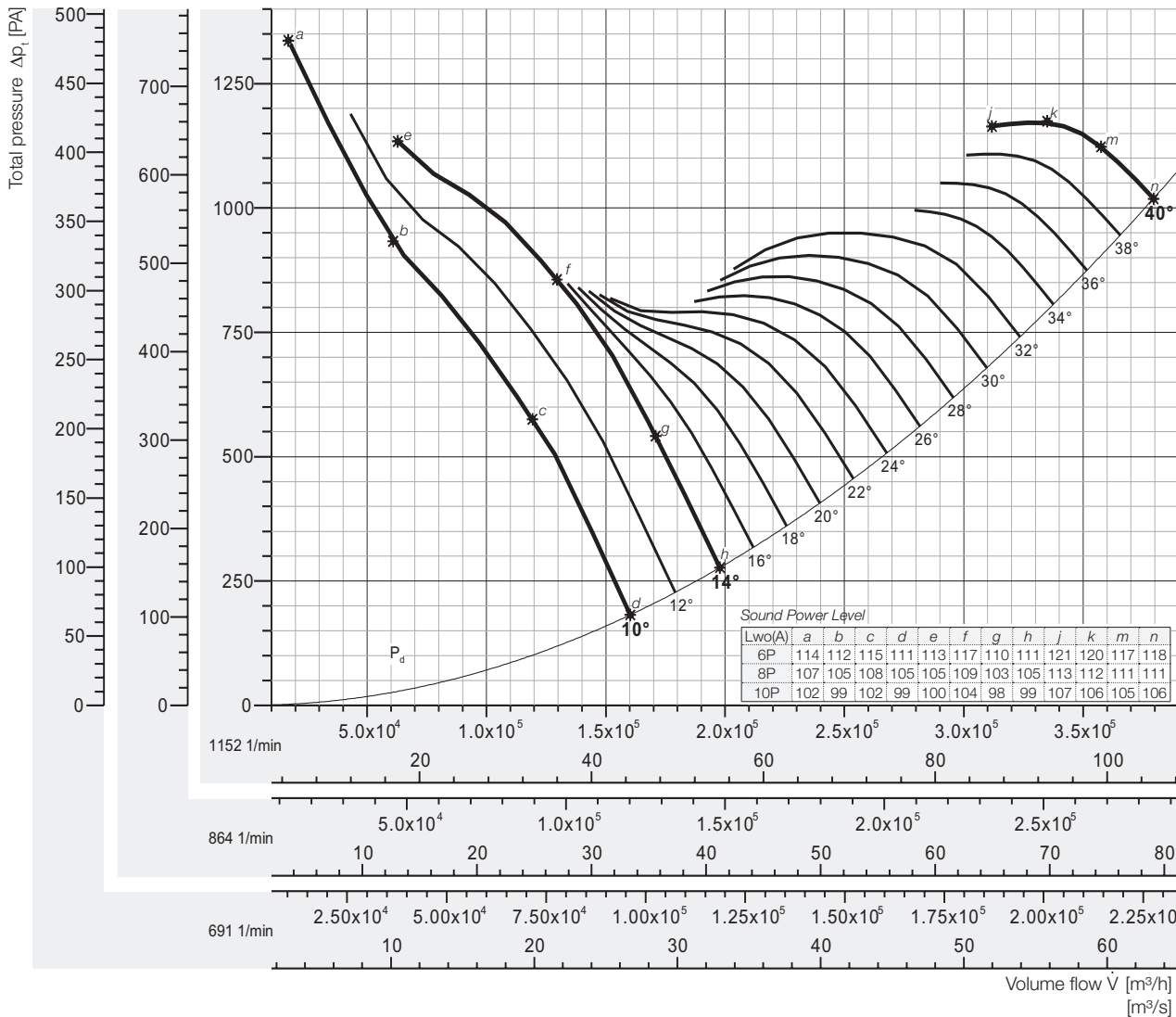
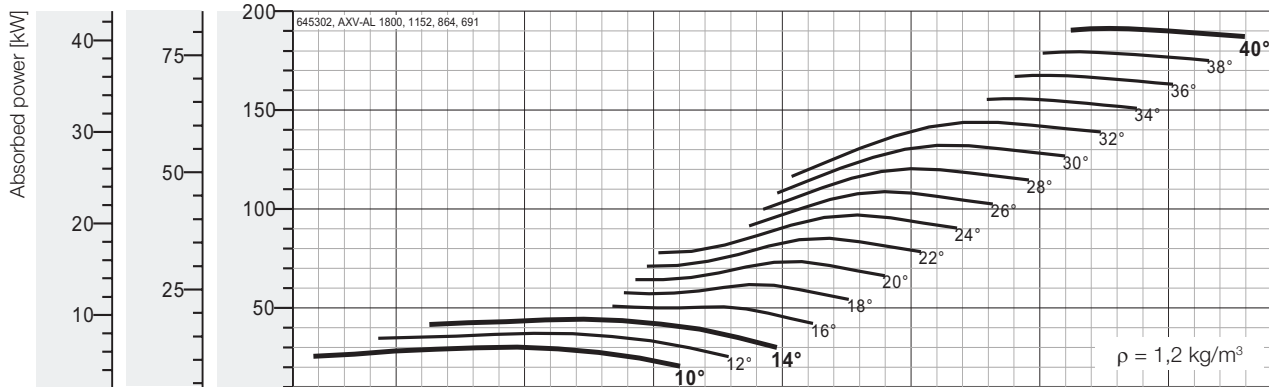

## Peak absorbed power [kW]

n [min <sup>-1</sup> ]	Pitch angle [°]																
	8	10	12	14	16	18	20	22	24	26	28	30	32	34	36	38	40
691 motor	-	6,50	8,01	9,56	11,0	13,3	15,8	18,4	20,9	23,5	26,0	28,5	31,0	33,6	36,2	38,7	41,3
864 motor	-	12,7	15,7	18,7	21,4	26,1	30,9	35,9	40,9	45,9	50,8	55,8	60,7	65,7	70,7	75,7	80,7
1152 motor	-	30,0	37,0	44,3	50,8	61,8	73,3	85,2	97,0	108,7	120,5	132,2	143,8	155,8	167,6	179,5	191,3

Fan test laboratory AMCA 210 Test Chamber. Performance certified is for installation type A - Free inlet, Free outlet. Performance ratings do not include the effects of appurtenances (accessories-belt cover, pulley & belt).

The A-weighted sound ratings shown have been calculated per AMCA International Standard 301. Values shown are for outlet LwoA sound power levels for installation Type A: free inlet, free outlet.

Dimensions + Accessories Page 191 - 194;  
Sound power frequency spectrum L<sub>max</sub> Page 196 - 200.



# Performance Curve

AXV 2000-600-6, 60 Hz

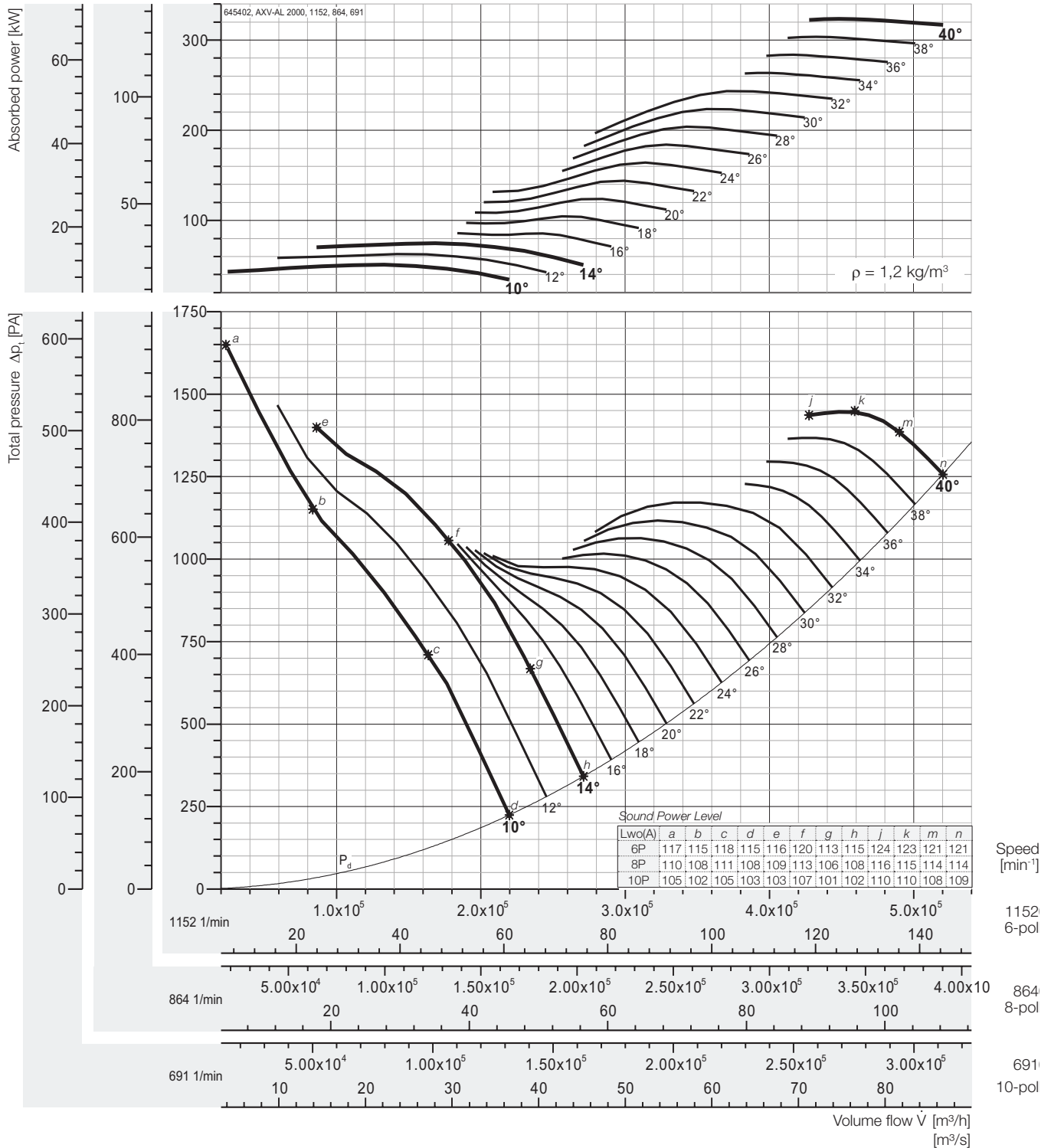

## Peak absorbed power [kW]

n [min <sup>-1</sup> ]	Pitch angle [°]																
	8	10	12	14	16	18	20	22	24	26	28	30	32	34	36	38	40
691 motor	-	11,0	13,6	16,2	18,5	22,6	26,8	31,1	35,4	39,7	44,0	48,3	52,5	56,9	61,2	65,5	69,8
864 motor	-	21,5	26,5	31,6	36,3	44,1	52,3	60,8	69,2	77,6	86,0	94,3	102,6	111,2	119,6	128,1	136,5
1152 motor	-	50,9	62,8	74,9	86,0	104,5	124,1	144,1	164,0	183,9	203,8	223,6	243,3	263,6	283,6	303,6	323,6

Fan test laboratory AMCA 210 Test Chamber. Performance certified is for installation type A - Free inlet, Free outlet. Performance ratings do not include the effects of appurtenances (accessories-belt cover, pulley & belt).

The A-weighted sound ratings shown have been calculated per AMCA International Standard 301. Values shown are for outlet L<sub>wa</sub>A sound power levels for installation Type A: free inlet, free outlet.

Dimensions + Accessories Page 191 - 194;  
Sound power frequency spectrum L<sub>wa</sub> Page 196 - 200.



# Performance Curve

AXV 2200-660-6, 60 Hz

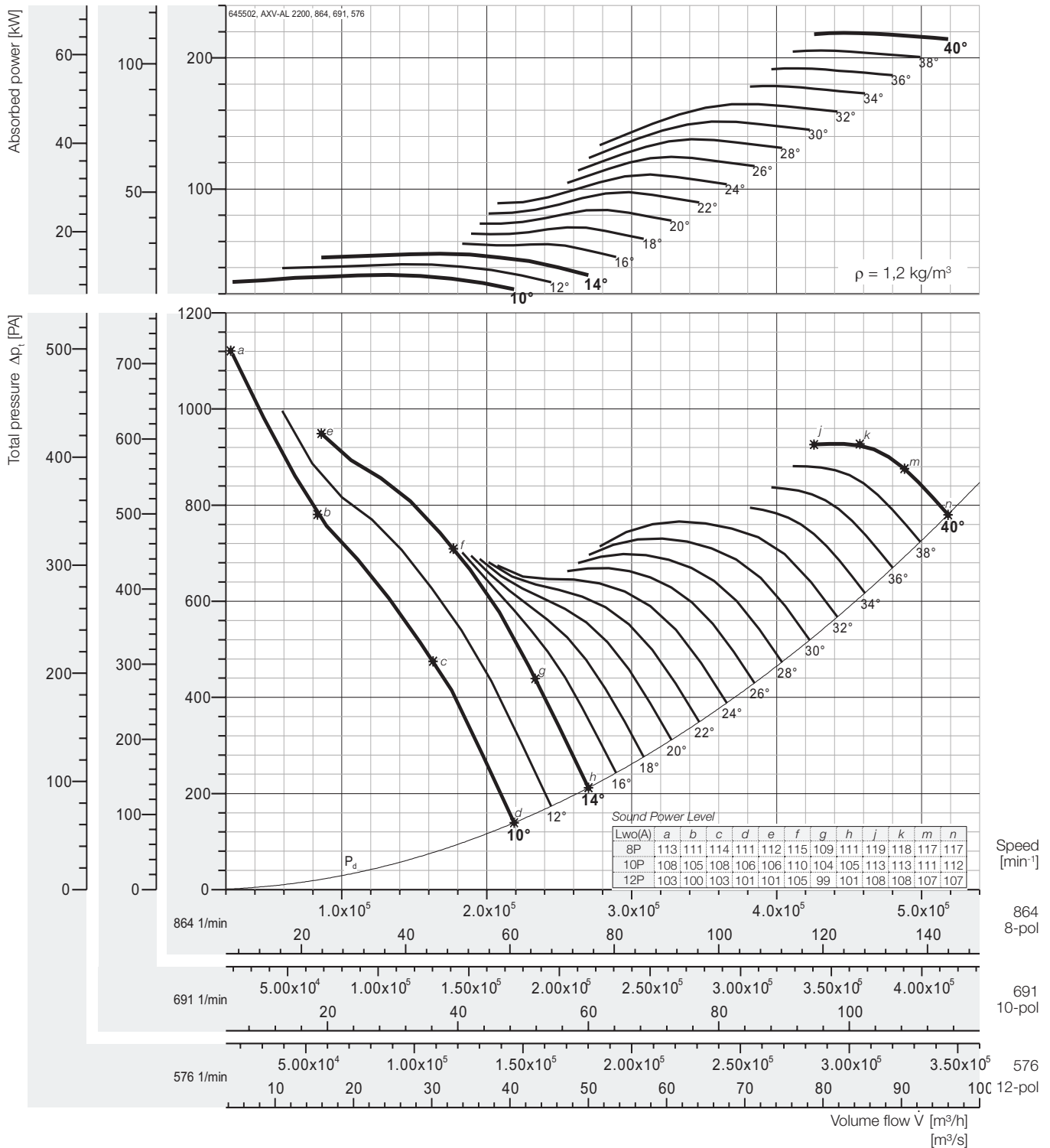

## Peak absorbed power [kW]

n [min <sup>-1</sup> ]	Pitch angle [°]																
	8	10	12	14	16	18	20	22	24	26	28	30	32	34	36	38	40
576 motor	-	10,2	12,6	15,0	17,3	21,0	24,9	28,9	32,9	36,9	40,9	44,9	48,8	52,9	56,9	60,9	64,9
691 motor	-	17,6	21,7	25,9	29,8	36,2	43,0	49,9	56,8	63,7	70,6	77,5	84,3	91,3	98,2	105,2	112,1
864 motor	-	34,5	42,5	50,7	58,3	70,8	84,0	97,6	111,1	124,6	138,0	151,4	164,8	178,5	192,1	205,6	219,2

Fan test laboratory AMCA 210 Test Chamber. Performance certified is for installation type A - Free inlet, Free outlet. Performance ratings do not include the effects of appurtenances (accessories-belt cover, pulley & belt).

The A-weighted sound ratings shown have been calculated per AMCA International Standard 301. Values shown are for outlet LwoA sound power levels for installation Type A: free inlet, free outlet.

Dimensions + Accessories Page 191 ~ 194;  
Sound power frequency spectrum L<sub>max</sub> Page 196 ~ 200.



# Performance Curve

AXV 2400-720-6, 60 Hz

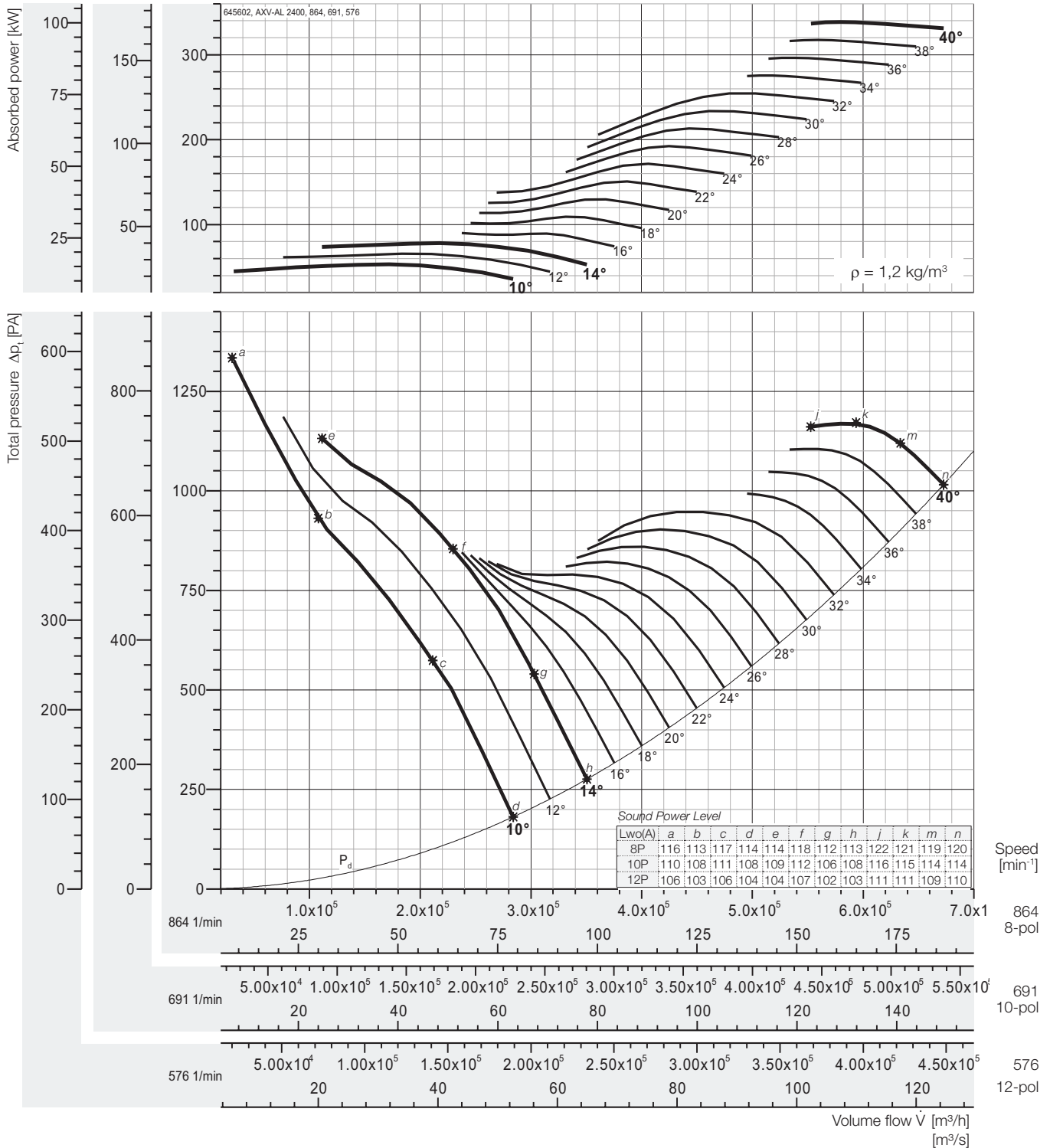

## Peak absorbed power [kW]

n [min <sup>-1</sup> ]	Pitch angle [°]																
	8	10	12	14	16	18	20	22	24	26	28	30	32	34	36	38	40
576 motor	-	15,8	19,5	23,2	26,7	32,4	38,4	44,6	50,8	57,0	63,2	69,3	75,4	81,7	87,9	94,1	100,3
691 motor	-	27,3	33,6	40,1	46,0	55,9	66,4	77,1	87,8	98,4	109,0	119,6	130,2	141,0	151,7	162,4	173,1
864 motor	-	53,3	65,7	78,3	89,9	109,3	129,7	150,7	171,5	192,4	213,1	233,8	254,5	275,7	296,6	317,5	338,4

Fan test laboratory AMCA 210 Test Chamber. Performance certified is for installation type A - Free inlet, Free outlet. Performance ratings do not include the effects of appurtenances (accessories-belt cover, pulley & belt).

The A-weighted sound ratings shown have been calculated per AMCA International Standard 301. Values shown are for outlet L<sub>w</sub>A sound power levels for installation Type A: free inlet, free outlet.

Dimensions + Accessories Page 191 - 194;  
Sound power frequency spectrum L<sub>w</sub> Page 196 - 200.



# Performance Curve

AXV 2500-750-6, 60 Hz

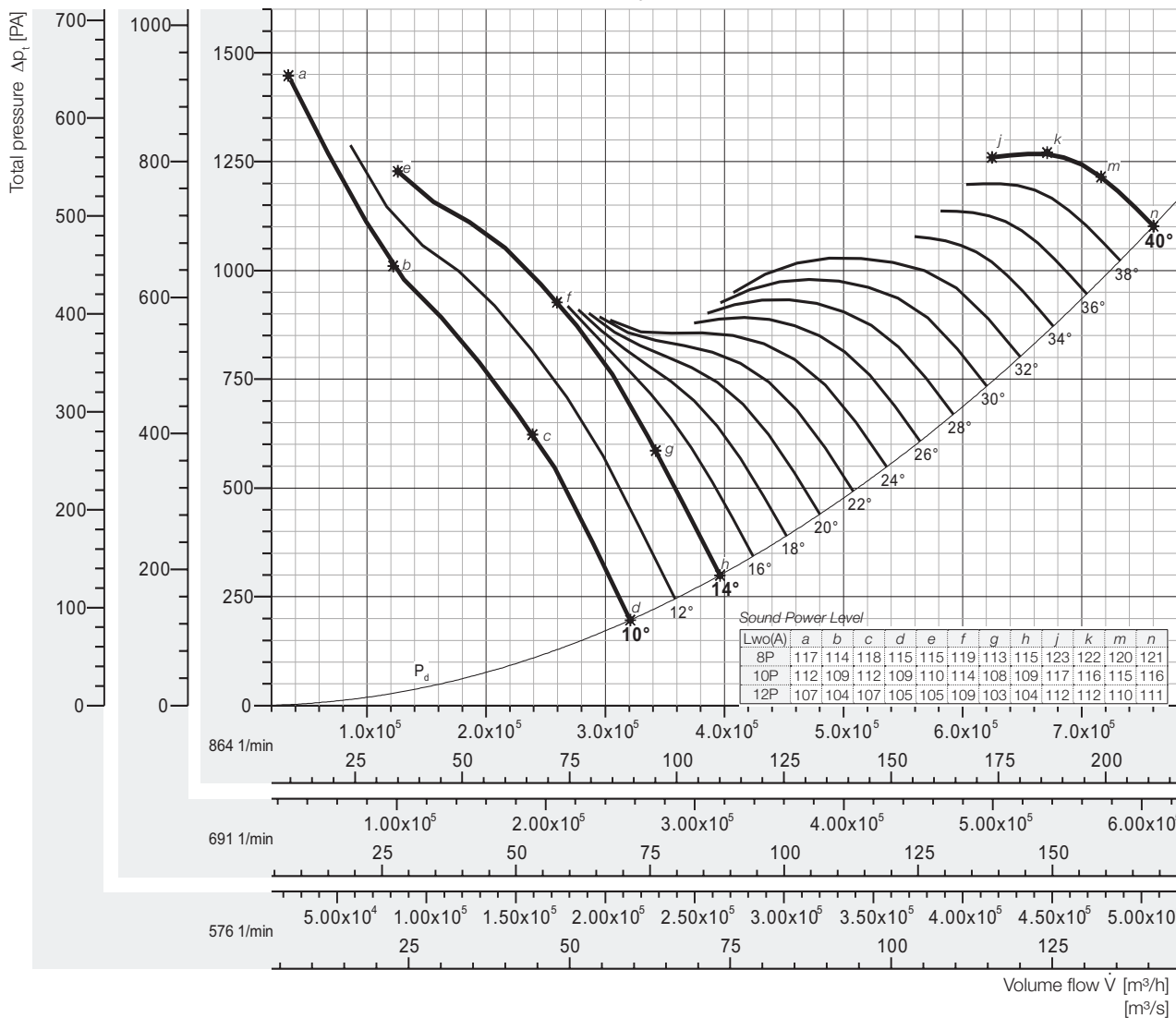
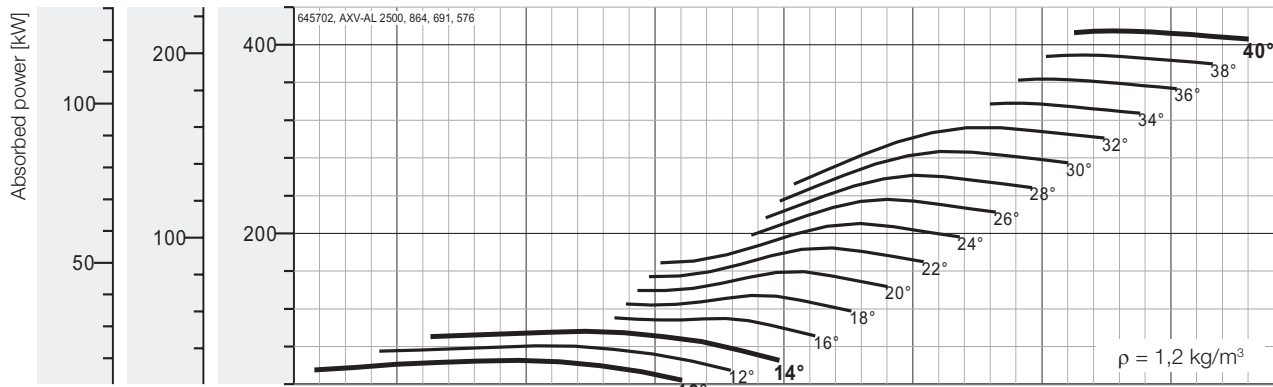

## Peak absorbed power [kW]

n [min <sup>-1</sup> ]	Pitch angle [°]																
	8	10	12	14	16	18	20	22	24	26	28	30	32	34	36	38	40
576 motor	-	19,4	23,9	28,4	32,7	39,7	47,1	54,7	62,3	69,9	77,4	84,9	92,4	100,1	107,7	115,3	122,9
691 motor	-	33,4	41,2	49,1	56,4	68,6	81,4	94,5	107,6	120,7	133,7	146,7	159,6	172,9	186,0	199,1	212,3
864 motor	-	65,3	80,5	96,0	110,3	134,1	159,1	184,7	210,3	235,9	261,3	286,7	312,0	338,0	363,6	389,3	414,9

Fan test laboratory AMCA 210 Test Chamber. Performance certified is for installation type A - Free inlet, Free outlet. Performance ratings do not include the effects of appurtenances (accessories-belt cover, pulley & belt).

The A-weighted sound ratings shown have been calculated per AMCA International Standard 301. Values shown are for outlet LwoA sound power levels for installation Type A: free inlet, free outlet.

Dimensions + Accessories Page 191 - 194;  
Sound power frequency spectrum L<sub>w</sub> Page 196 - 200.



# Performance Curve

AXV 2600-780-6, 60 Hz

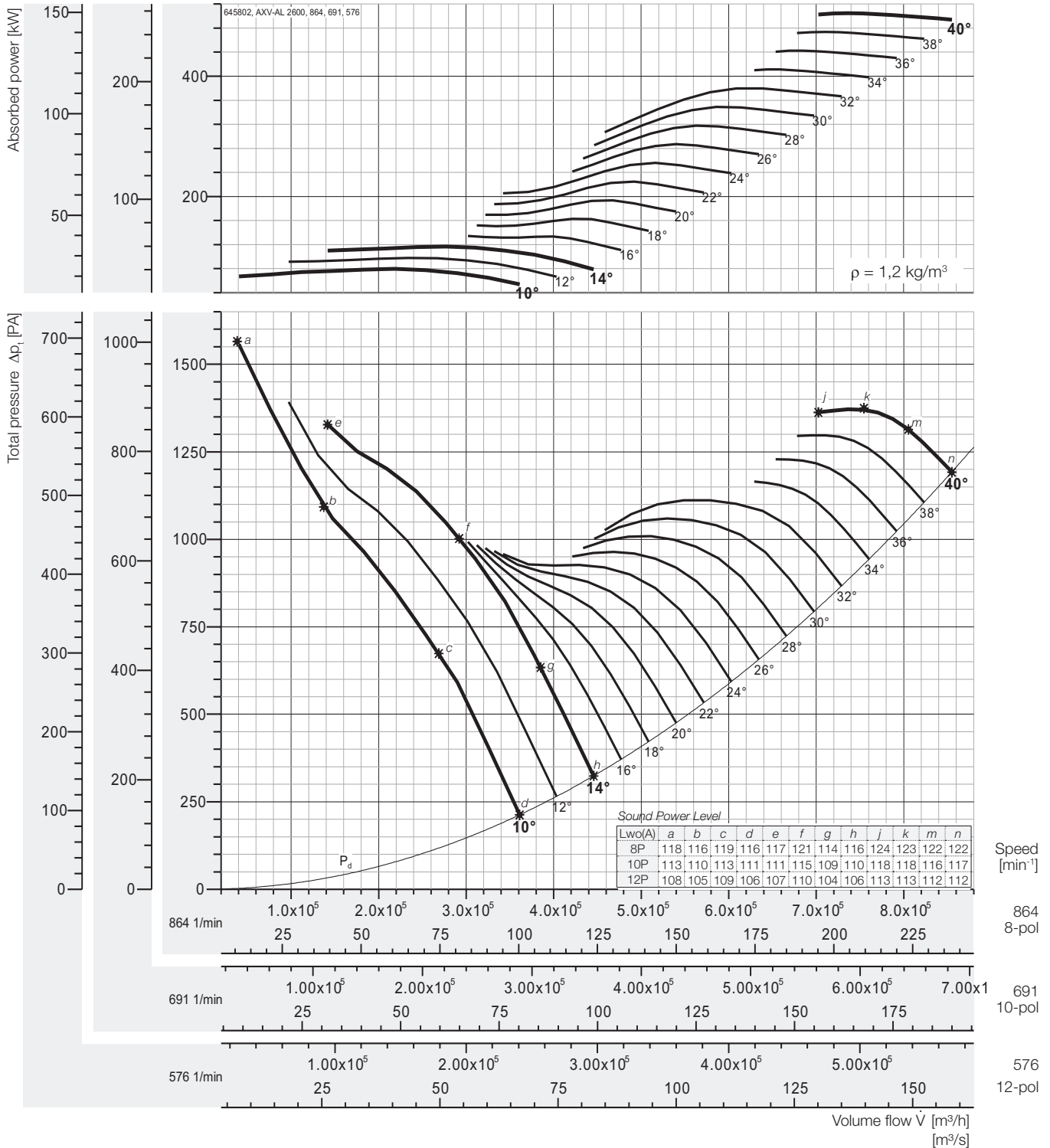

## Peak absorbed power [kW]

n [min <sup>-1</sup> ]	Pitch angle [°]																
	8	10	12	14	16	18	20	22	24	26	28	30	32	34	36	38	40
576 motor	-	23,5	29,0	34,6	39,8	48,3	57,3	66,6	75,8	85,0	94,2	103,3	112,4	121,8	131,0	140,3	149,5
		30		37	45	55	75		90		110		132		160		
691 motor	-	40,6	50,1	59,8	68,6	83,4	99,0	115,0	130,9	146,8	162,6	178,4	194,1	210,3	226,3	242,2	258,2
		45	55	75	90	110	132		160	200		250				315	
864 motor	-	79,4	98,0	116,8	134,2	163,1	193,5	224,7	255,9	286,9	317,9	348,7	379,5	411,1	442,3	473,5	504,7
		90	110	160		200	250	315		355	450				500	560	

Fan test laboratory AMCA 210 Test Chamber. Performance certified is for installation type A - Free inlet, free outlet. Performance ratings do not include the effects of appurtenances (accessories-belt cover, pulley & belt).

The A-weighted sound ratings shown have been calculated per AMCA International Standard 301. Values shown are for outlet L<sub>w</sub>A sound power levels for installation Type A: free inlet, free outlet.

Dimensions + Accessories Page 191 - 194;  
Sound power frequency spectrum L<sub>w</sub> Page 196 - 200.



# Performance Curve

AXV 2800-840-6, 60 Hz

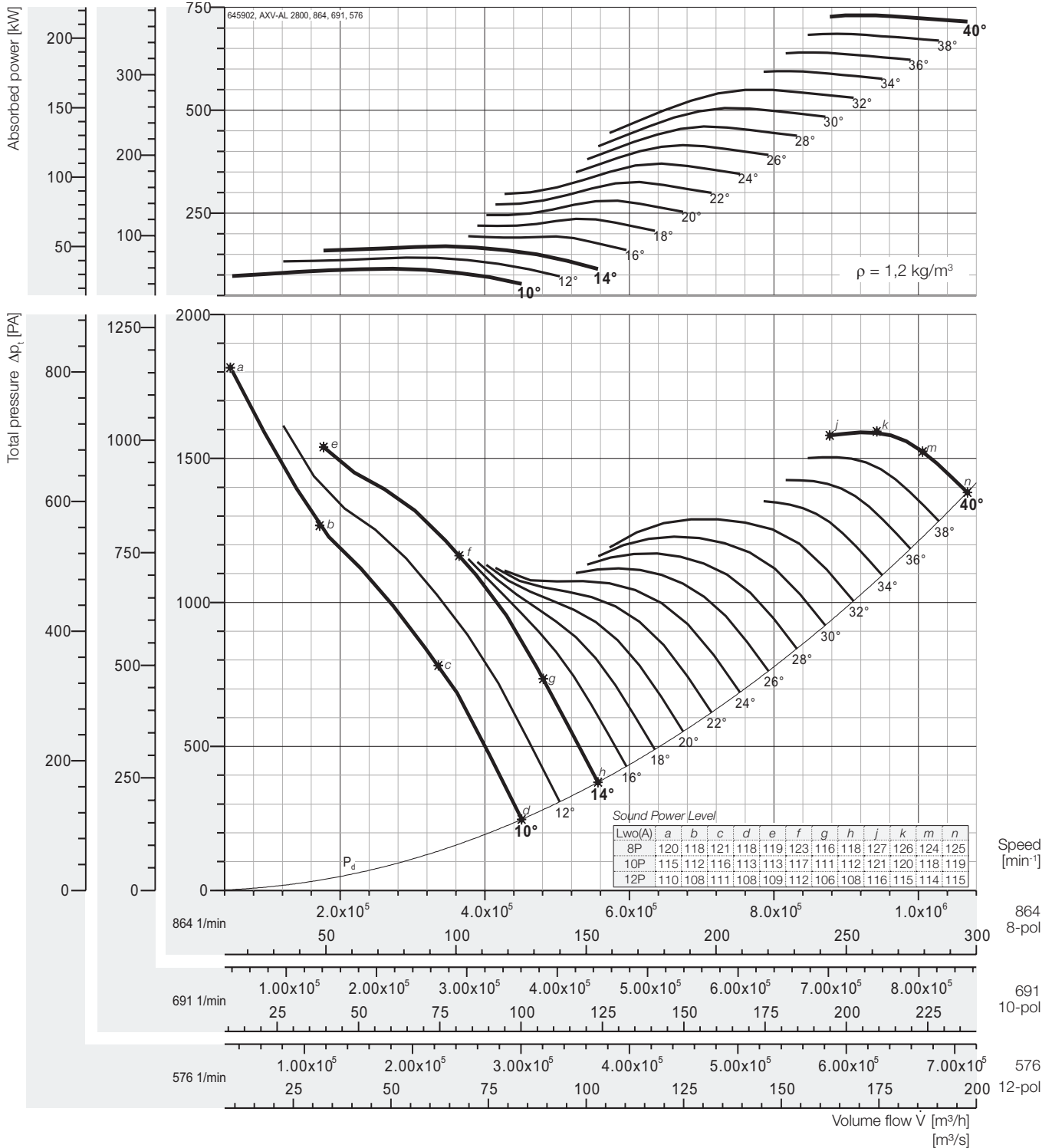

## Peak absorbed power [kW]

n [min <sup>-1</sup> ]	Pitch angle [°]																
	8	10	12	14	16	18	20	22	24	26	28	30	32	34	36	38	40
576 motor	-	34,1	42,0	50,1	57,6	70,0	83,0	96,4	109,8	123,1	136,4	149,6	162,8	176,4	189,7	203,1	216,5
		37	45	55	75		90	110		132	160		200			250	
691 motor	-	58,8	72,6	86,5	99,4	120,8	143,3	166,4	189,5	212,5	235,4	258,3	281,1	304,5	327,6	350,7	373,8
		75		90	110	132	160	200		250		315		355		450	
864 motor	-	115,0	141,9	169,2	194,3	236,1	280,2	325,4	370,5	415,4	460,3	504,9	549,5	595,3	640,4	685,6	730,8
		132	160	200		250	315	355	450		500	560		630	710		-

Fan test laboratory AMCA 210 Test Chamber. Performance certified is for installation type A - Free inlet, Free outlet. Performance ratings do not include the effects of appurtenances (accessories-belt cover, pulley & belt).

The A-weighted sound ratings shown have been calculated per AMCA International Standard 301. Values shown are for outlet LwoA sound power levels for installation Type A: free inlet, free outlet.

Dimensions + Accessories Page 191 - 194;  
Sound power frequency spectrum L<sub>max</sub> Page 196 - 200.



**Introducing the Fan Energy Index**

The FEI is a ratio of the actual fan efficiency to a baseline fan efficiency, both calculated at a given airflow and pressure.  $FEI_s$  is calculated using a static pressure basis,  $FEI_t$  is calculated using a total pressure basis. Since these efficiencies are each calculated at the same airflow and pressure, FEI is also defined as the ratio of the baseline electrical power to the actual electrical power of a fan.

The FEI was designed to encourage responsible application of fans and drive significant and quantifiable energy savings through energy codes, utility rebate programs and federal regulations. This is accomplished by establishing the minimum fan efficiency or maximum fan electrical input power at design airflow and pressure. The FEI can be used by:

- Regulators to improve the efficiency of fan designs and limit market availability of less efficient fans
- Utilities to establish rebate programs to incentivize the efficient use of fans
- Code bodies to drive building owners and contractors to using more energy efficient fans for ventilation and process applications
- Purchasing agents to evaluate the fan selections and their suitability for specific applications

**Selection Example**

The **direct driven** axial fan AXV 450-110-6/20° with three-phase **60Hz** motor power supply, by plotting the FEI curve as per the right graph, the  $FEI_t$  value will be 1.98 under the duty **5,000CMH** airflow, **167Pa total pressure** running at **1,800rpm**.

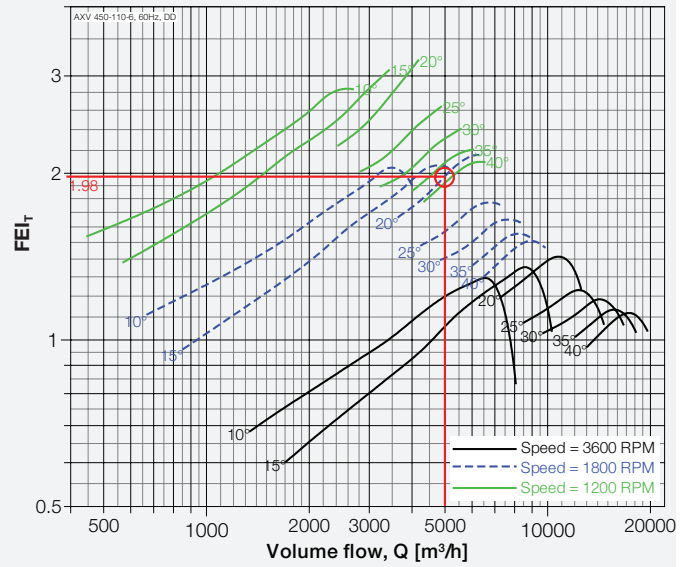

**Direct Driven Models, Size from 250 to 2800, 60Hz**

Model: AXV 250-110-3

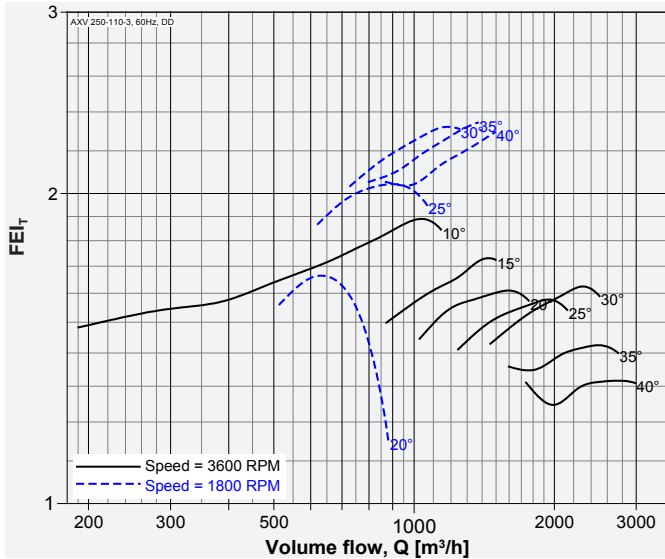

Model: AXV 250-110-6

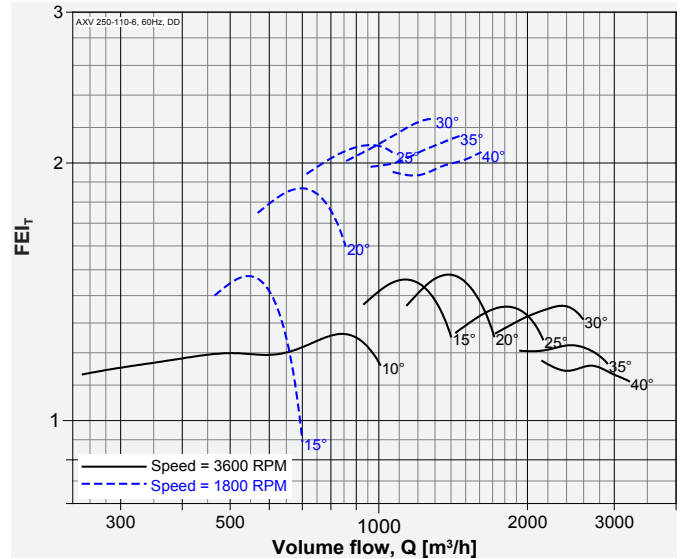

Model: AXV 280-110-3

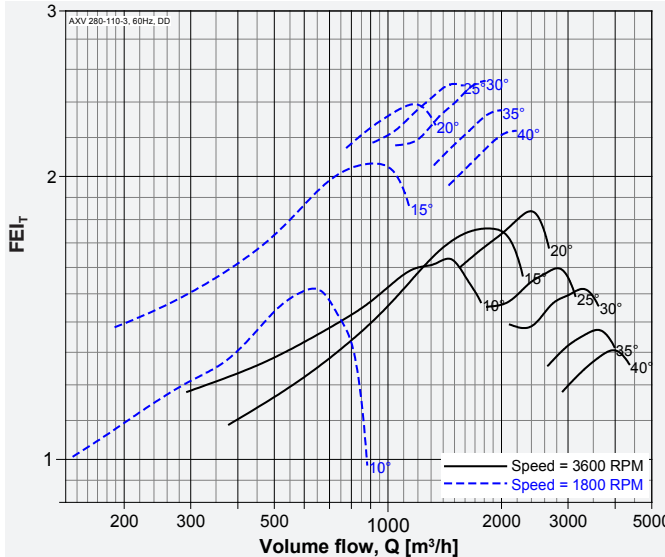

Model: AXV 280-110-6

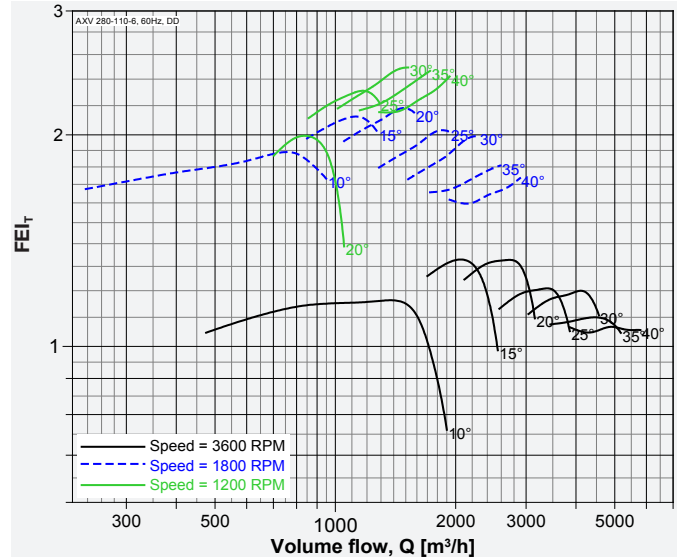

Performance of size 250 to 1250 certified is for installation type D - Ducted inlet, Ducted outlet, Performance of size 1400 to 2800 certified is for installation type A - Free inlet, Free outlet. Power rating (kW) does not include transmission losses. Performance ratings do not include the effects of appurtenances (accessories-belt cover, pulley & belt).  $FEI_t$  /  $FEI_s$  values are calculated in accordance with ANSI/AMCA Standard 208 and are based on default motor efficiencies (Direct Driven type).  $FEI_t$  /  $FEI_s$  values for fans with specific motors will vary slightly from those shown.





Model: AXV 315-110-3

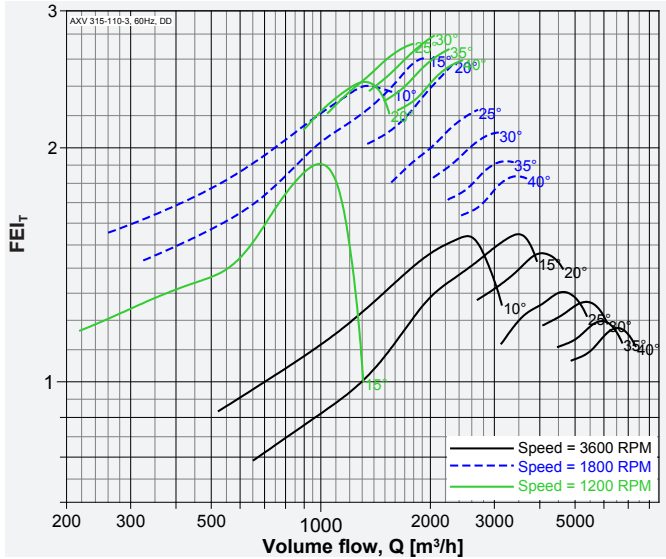

Model: AXV 315-110-6

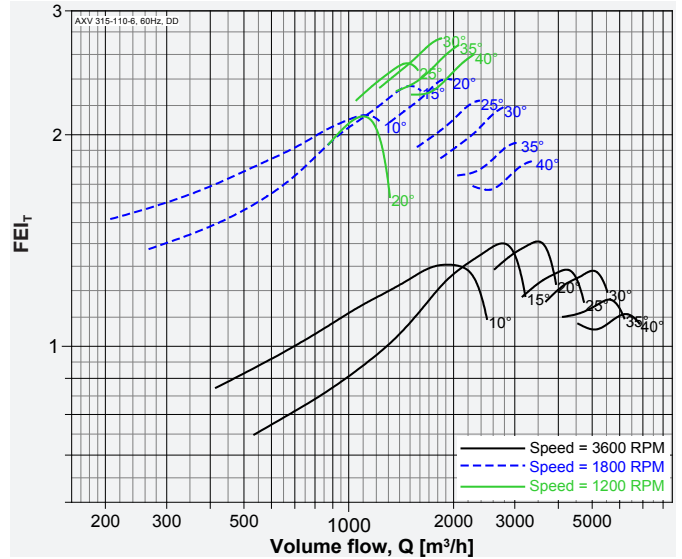

Model: AXV 355-110-3

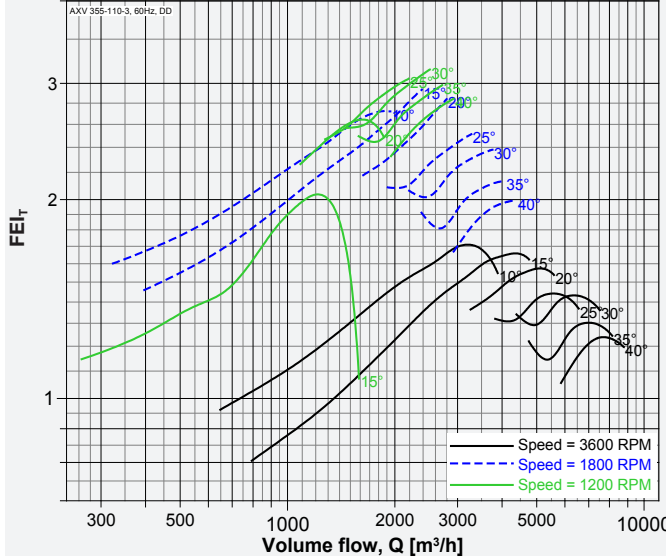

Model: AXV 355-110-6

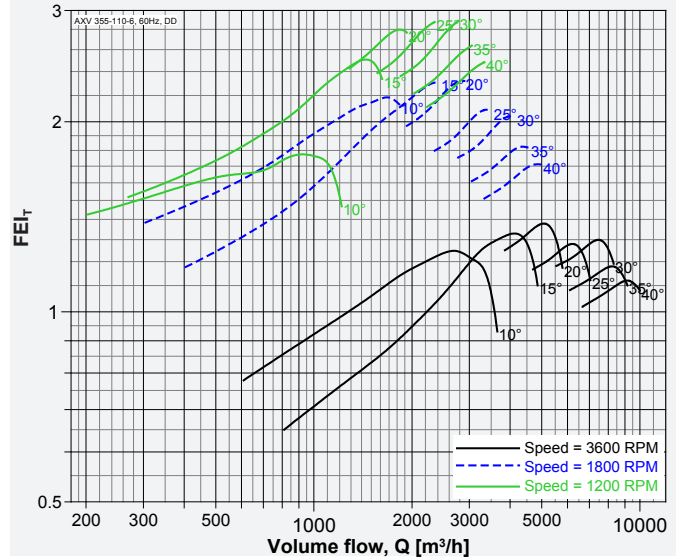

Model: AXV 355-150-7

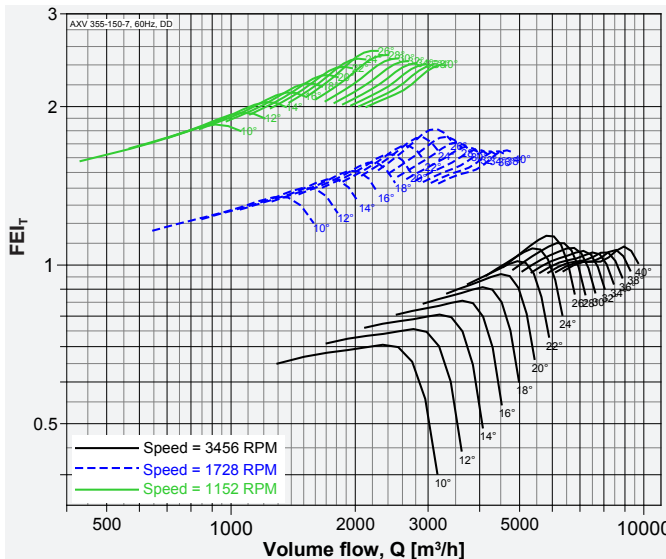

Model: AXV 400-110-3

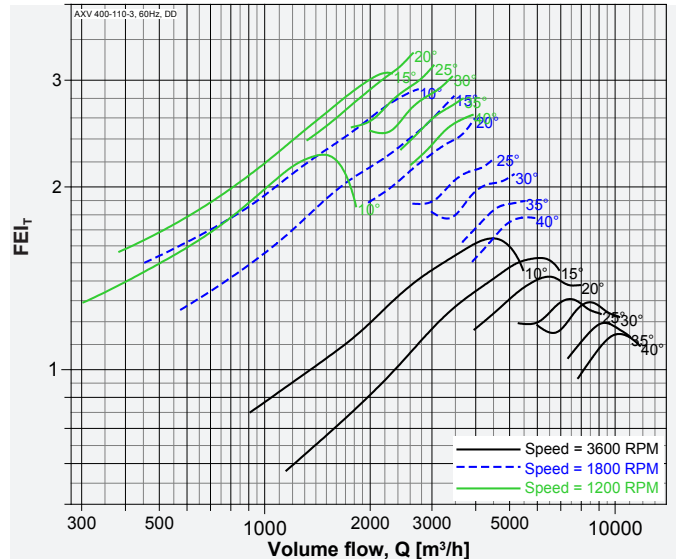

Performance of size 250 to 1250 certified is for installation type D - Ducted inlet, Ducted outlet, Performance of size 1400 to 2800 certified is for installation type A - Free inlet, Free outlet. Power rating (kW) does not include transmission losses. Performance ratings do not include the effects of appurtenances (accessories-belt cover, pulley & belt). FEI<sub>T</sub> / FEI<sub>S</sub> values are calculated in accordance with ANSI/AMCA Standard 208 and are based on default motor efficiencies (Direct Driven type). FEI<sub>T</sub> / FEI<sub>S</sub> values for fans with specific motors will vary slightly from those shown.



Model: AXV 400-110-6

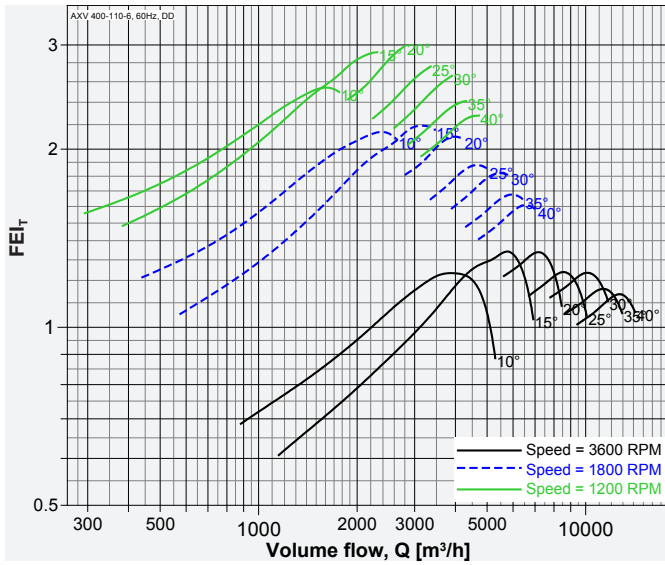

Model: AXV 400-150-5

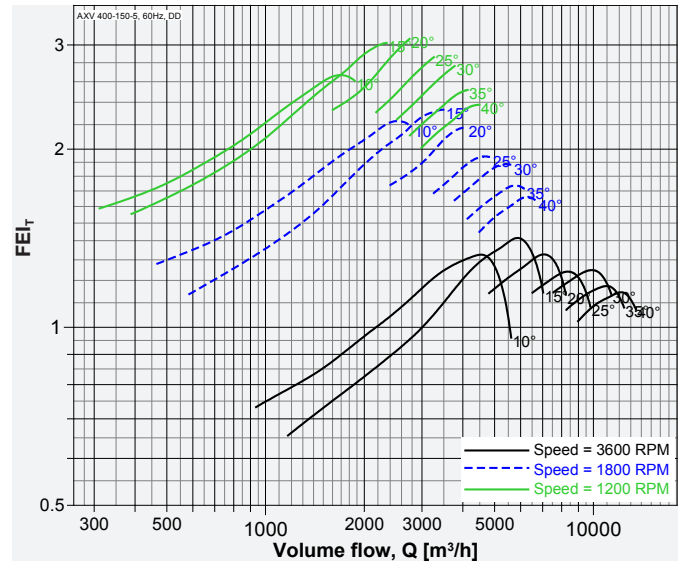

Model: AXV 400-150-7

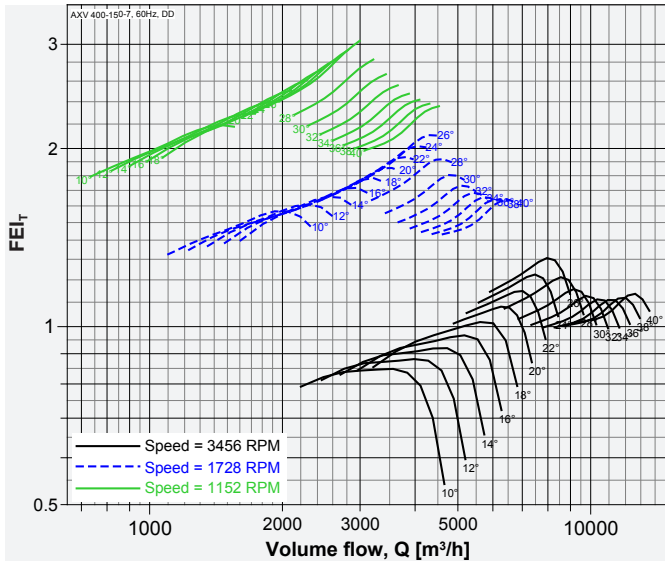

Model: AXV 400-150-10

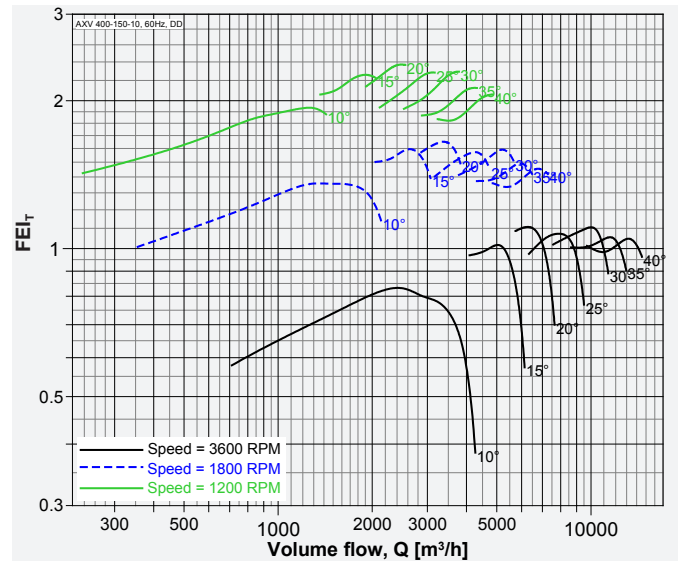

Model: AXV 450-110-3

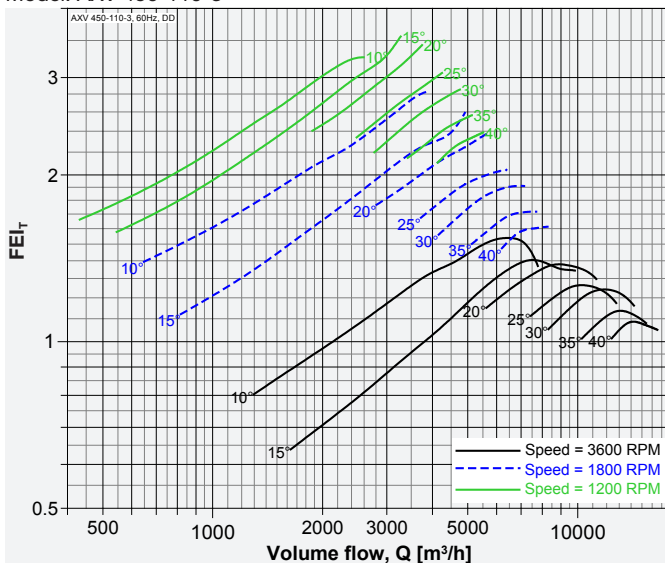

Model: AXV 450-110-6

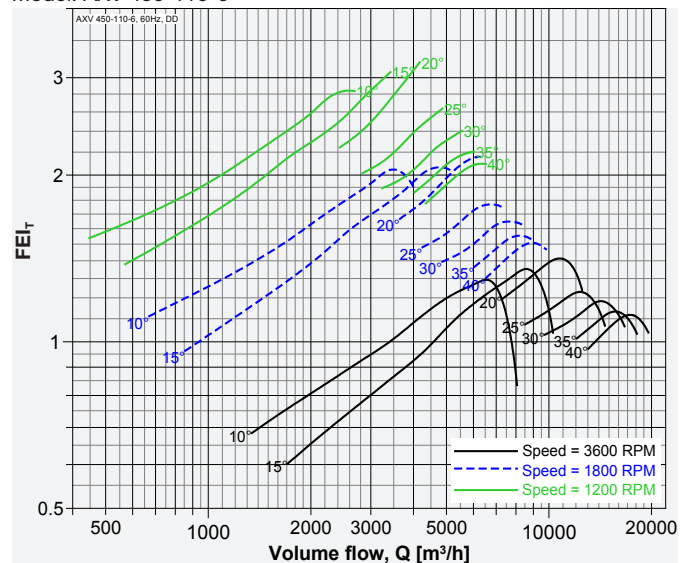

Performance of size 250 to 1250 certified is for installation type D - Ducted inlet, Ducted outlet, Performance of size 1400 to 2800 certified is for installation type A - Free inlet, Free outlet. Power rating (kW) does not include transmission losses. Performance ratings do not include the effects of appurtenances (accessories-belt cover, pulley & belt). FEI<sub>t</sub> / FEI<sub>s</sub> values are calculated in accordance with ANSI/AMCA Standard 208 and are based on default motor efficiencies (Direct Driven type). FEI<sub>t</sub> / FEI<sub>s</sub> values for fans with specific motors will vary slightly from those shown.



Model: AXV 450-150-5

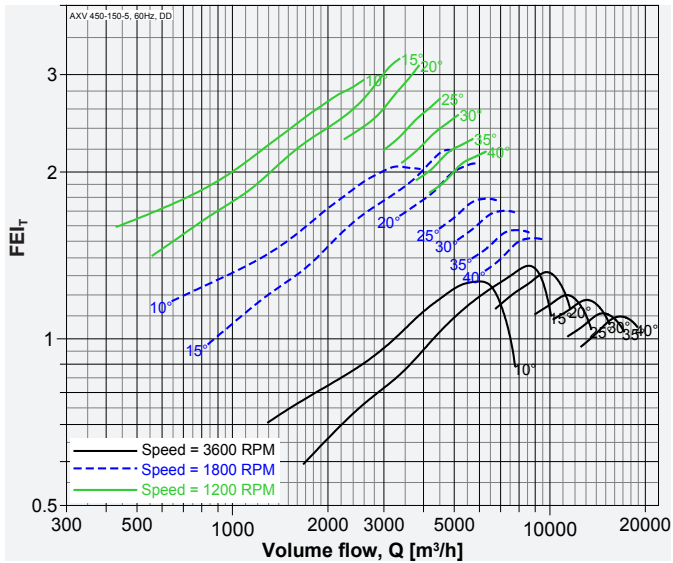

Model: AXV 450-150-7

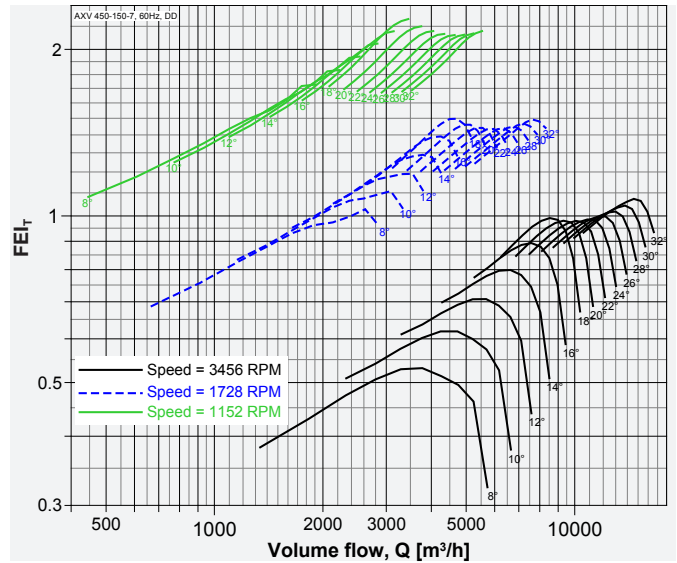

Model: AXV 450-150-10

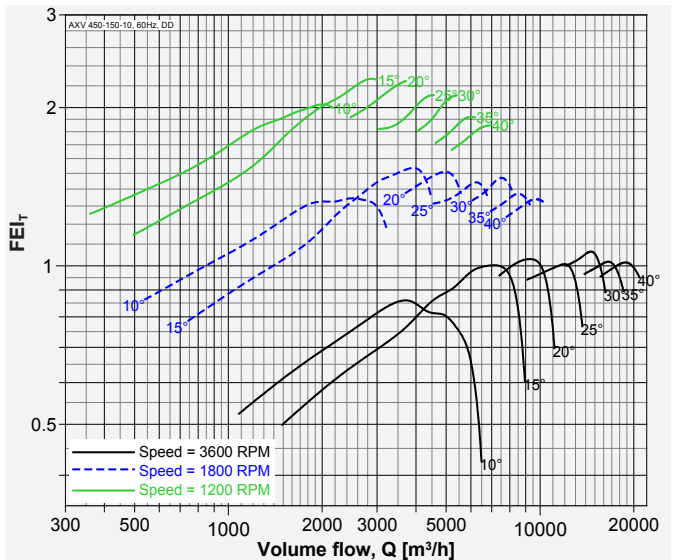

Model: AXV 500-110-3

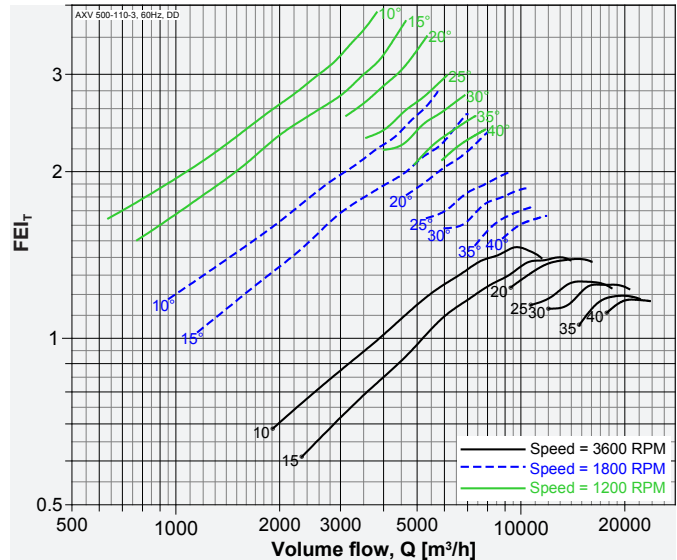

Model: AXV 500-110-6

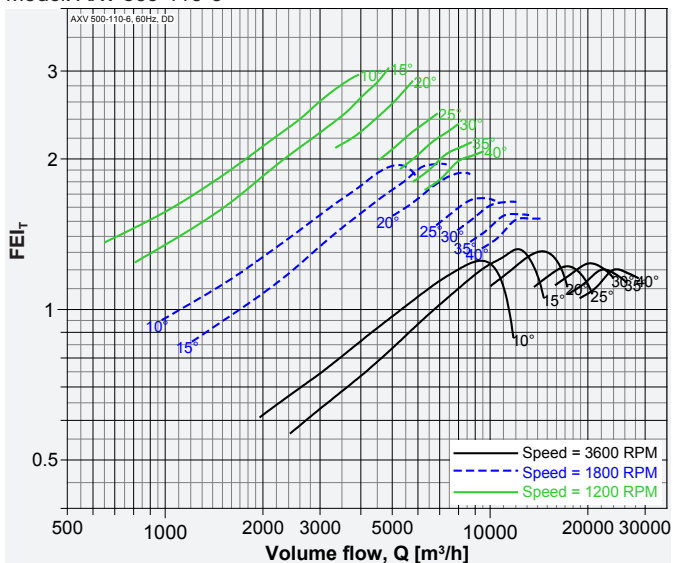

Model: AXV 500-150-5

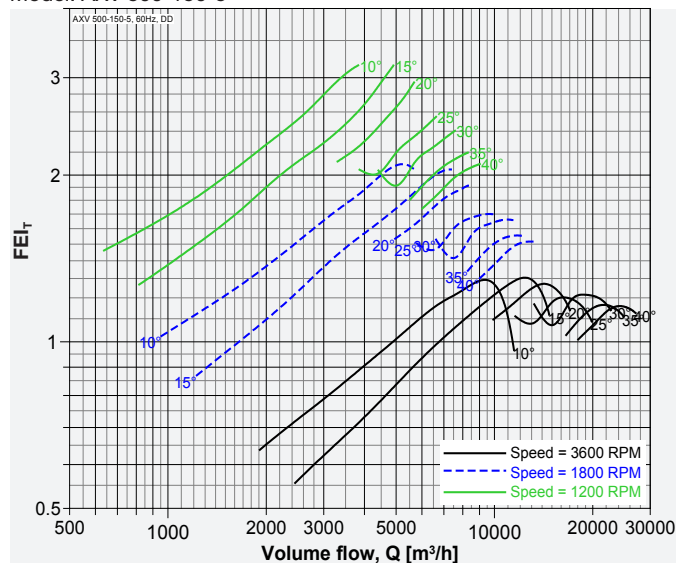

Performance of size 250 to 1250 certified is for installation type D - Ducted inlet, Ducted outlet, Performance of size 1400 to 2800 certified is for installation type A - Free inlet, Free outlet. Power rating (kW) does not include transmission losses. Performance ratings do not include the effects of appurtenances (accessories-belt cover, pulley & belt). FEI<sub>r</sub> / FEI<sub>s</sub> values are calculated in accordance with ANSI/AMCA Standard 208 and are based on default motor efficiencies (Direct Driven type). FEI<sub>r</sub> / FEI<sub>s</sub> values for fans with specific motors will vary slightly from those shown.



Model: AXV 500-150-7

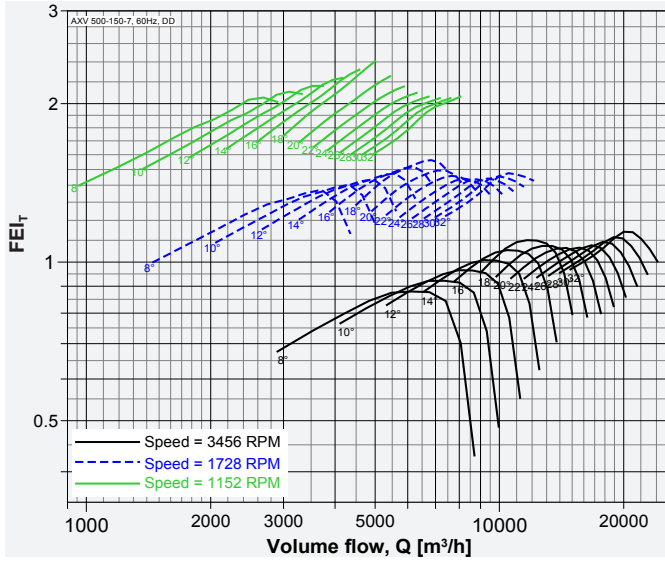

Model: AXV 500-150-10

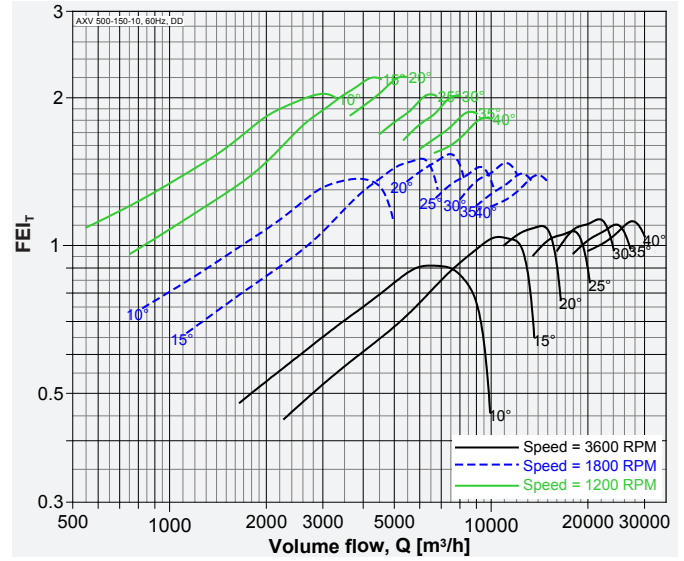

Model: AXV 500-250-7

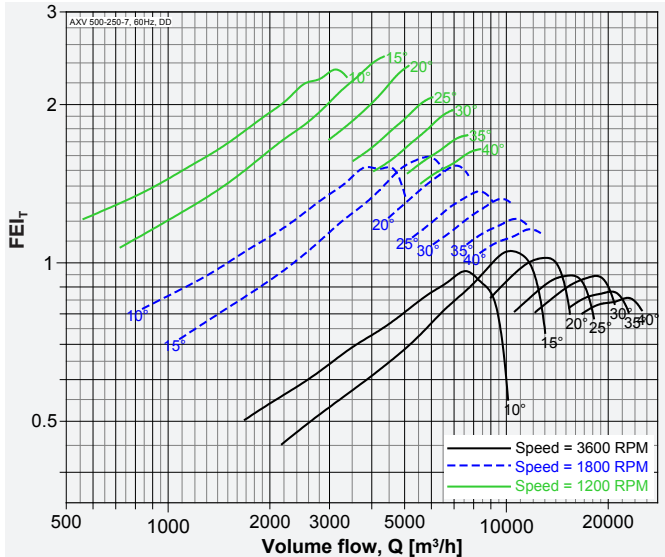

Model: AXV 560-110-3

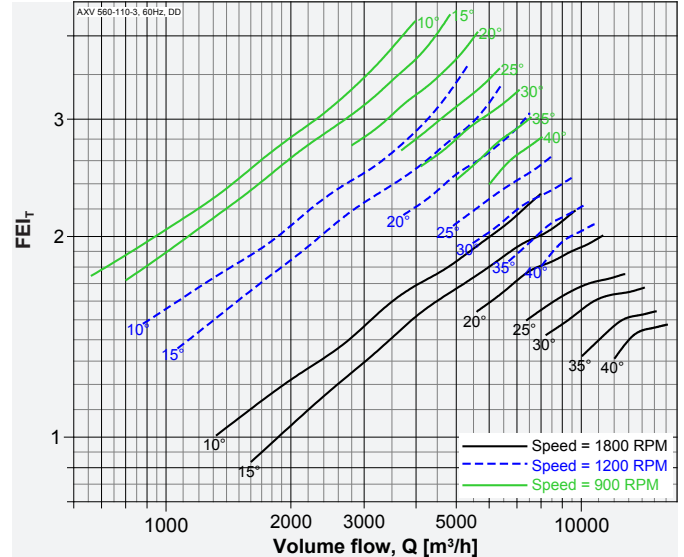

Model: AXV 560-110-6

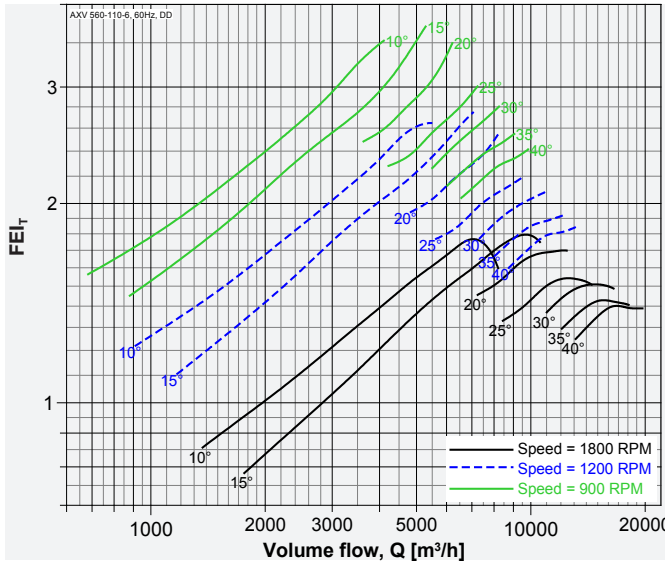

Model: AXV 560-150-5

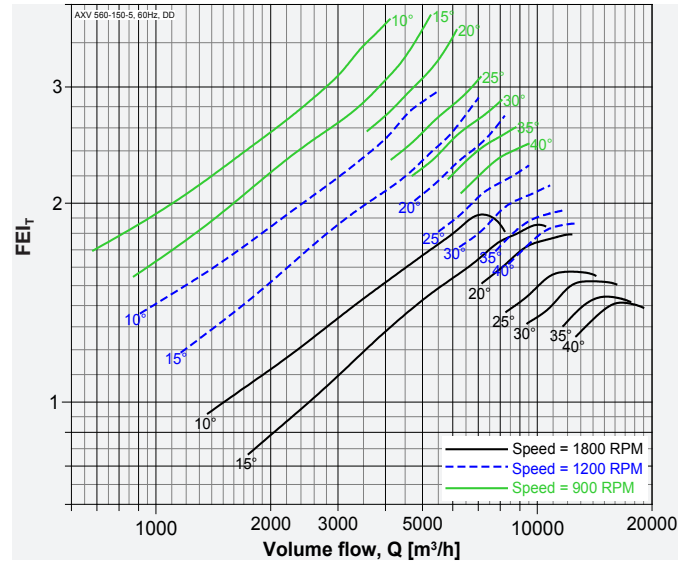

Performance of size 250 to 1250 certified is for installation type D - Ducted inlet, Ducted outlet, Performance of size 1400 to 2800 certified is for installation type A - Free inlet, Free outlet. Power rating (kW) does not include transmission losses. Performance ratings do not include the effects of appurtenances (accessories-belt cover, pulley & belt). FEI<sub>T</sub> / FEI<sub>S</sub> values are calculated in accordance with ANSI/AMCA Standard 208 and are based on default motor efficiencies (Direct Driven type). FEI<sub>T</sub> / FEI<sub>S</sub> values for fans with specific motors will vary slightly from those shown.



Model: AXV 560-150-10

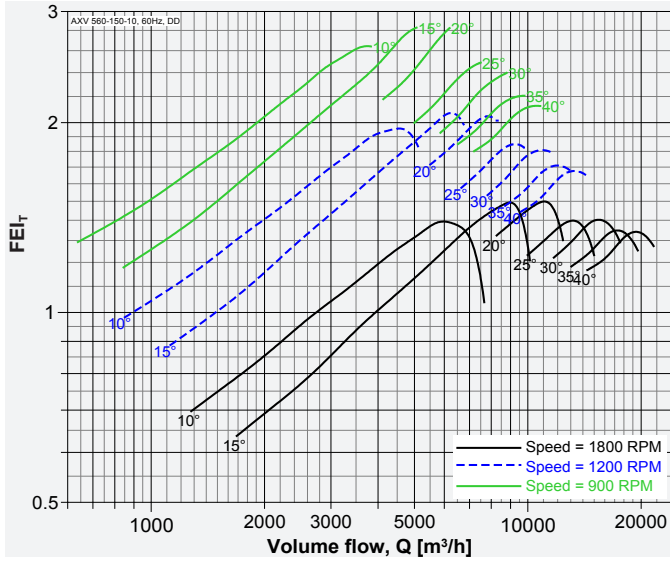

Model: AXV 560-200-9

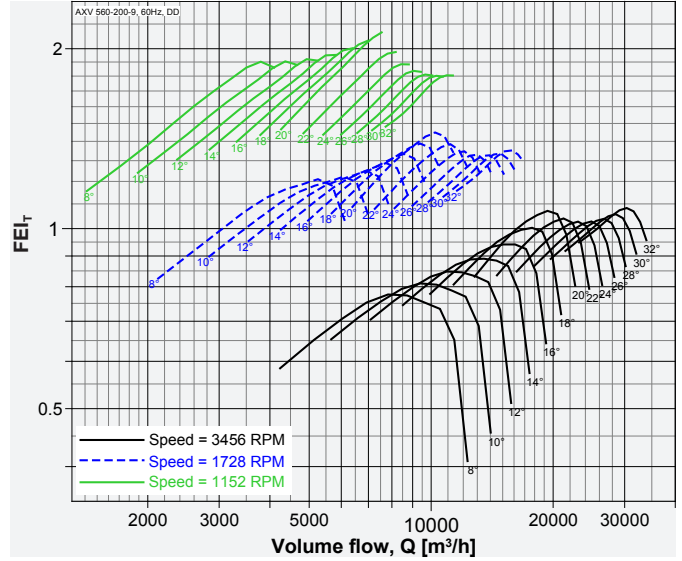

Model: AXV 560-250-7

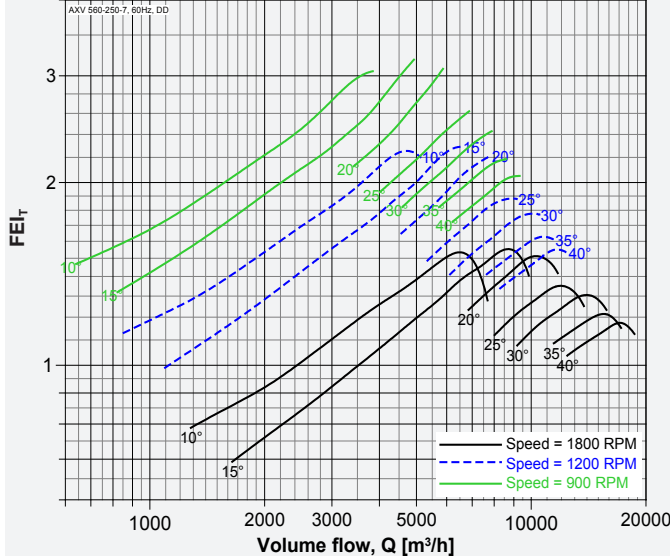

Model: AXV 560-250-14

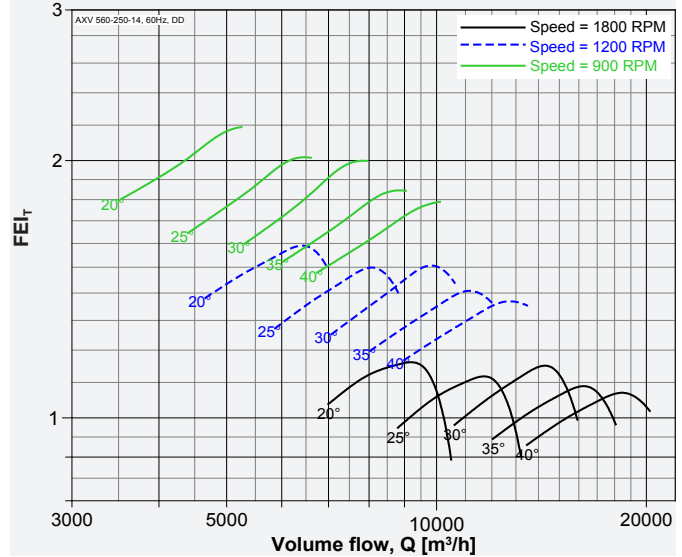

Model: AXV 630-110-3

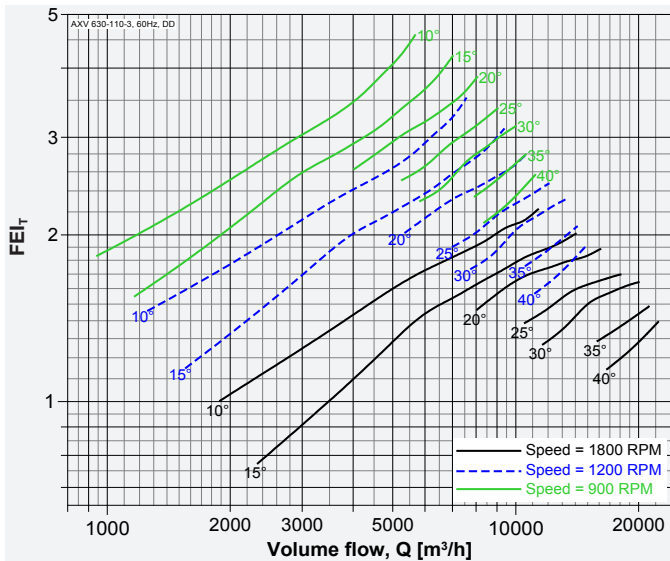

Model: AXV 630-110-6

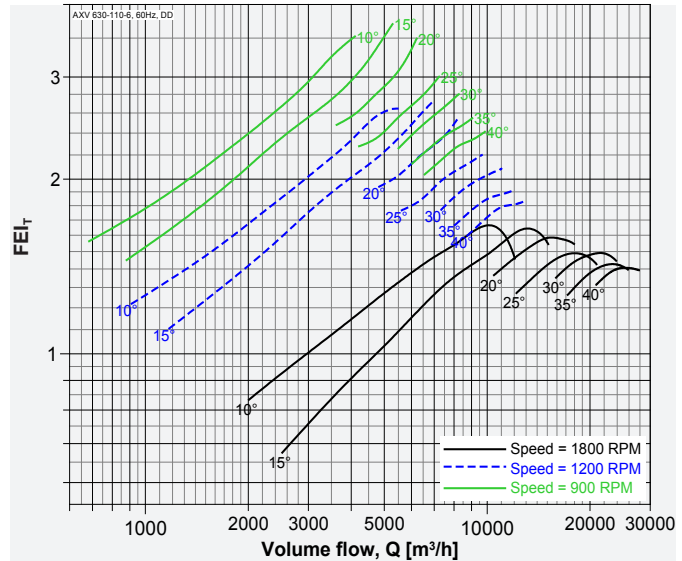

Performance of size 250 to 1250 certified is for installation type D - Ducted inlet, Ducted outlet, Performance of size 1400 to 2800 certified is for installation type A - Free inlet, Free outlet. Power rating (kW) does not include transmission losses. Performance ratings do not include the effects of appurtenances (accessories-belt cover, pulley & belt). FEI<sub>r</sub> / FEI<sub>s</sub> values are calculated in accordance with ANSI/AMCA Standard 208 and are based on default motor efficiencies (Direct Driven type). FEI<sub>r</sub> / FEI<sub>s</sub> values for fans with specific motors will vary slightly from those shown.



Model: AXV 630-150-5

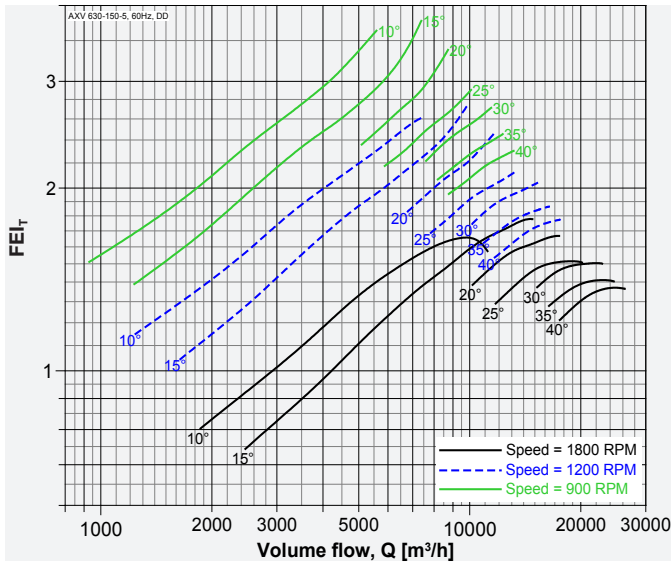

Model: AXV 630-150-10

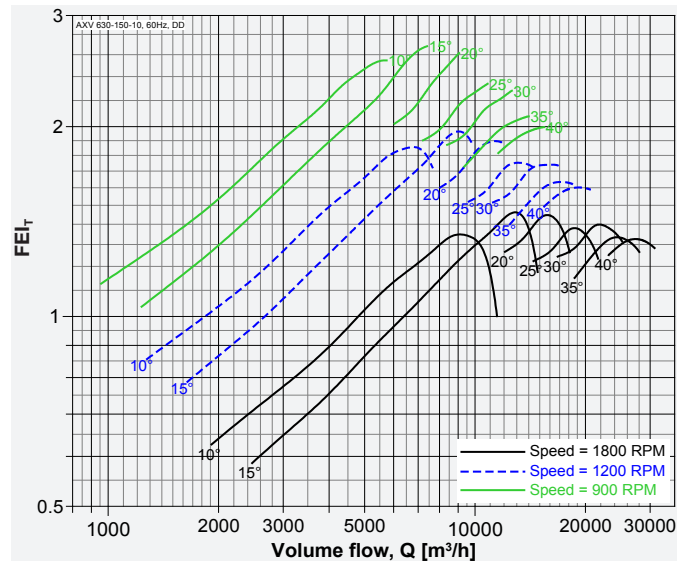

Model: AXV 630-200-9

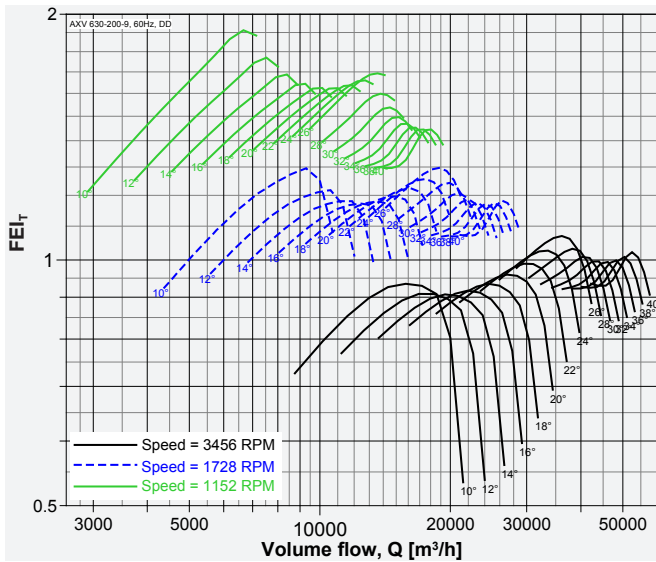

Model: AXV 630-250-7

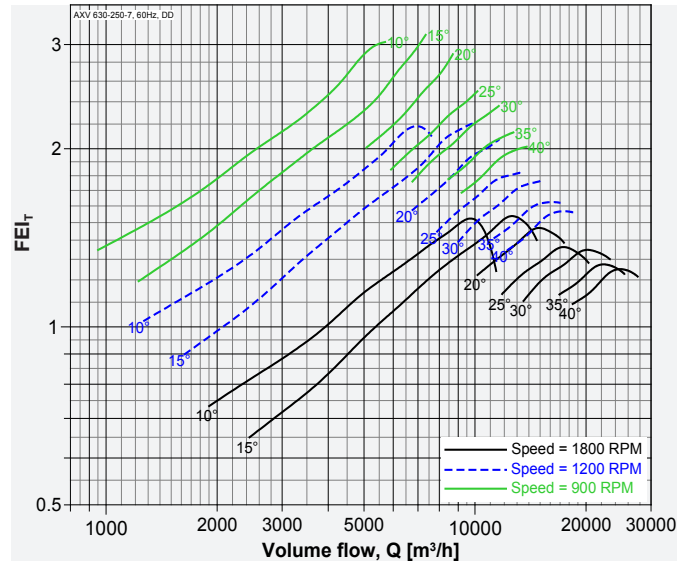

Model: AXV 630-250-14

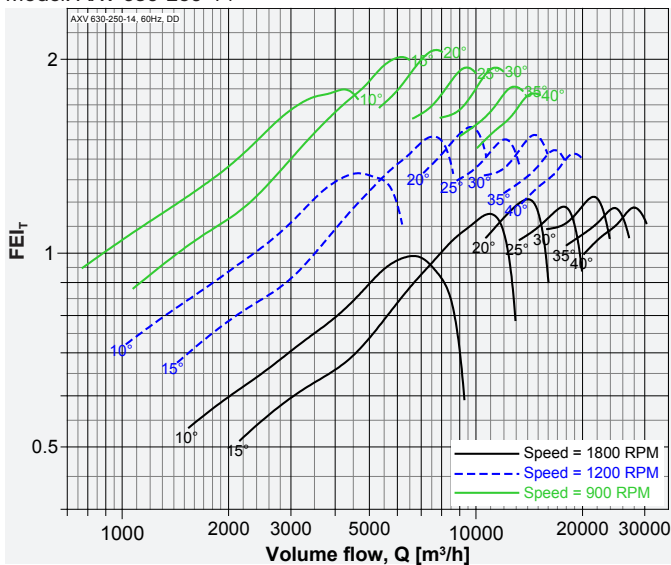

Model: AXV 710-110-3

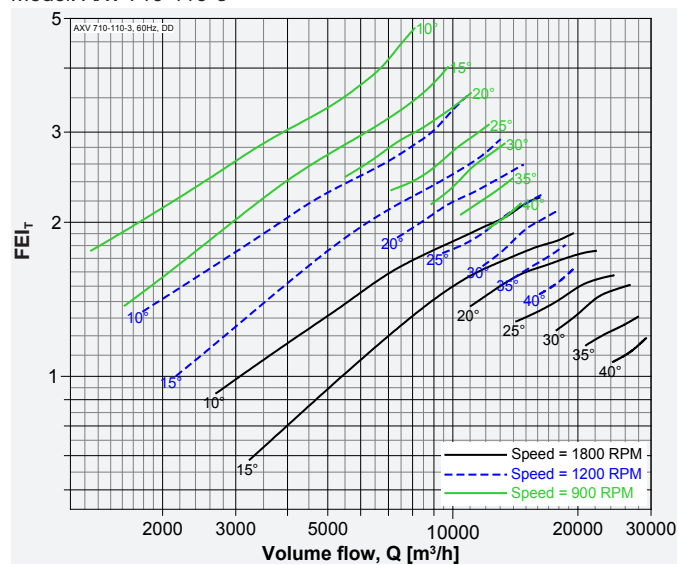

Performance of size 250 to 1250 certified is for installation type D - Ducted inlet, Ducted outlet, Performance of size 1400 to 2800 certified is for installation type A - Free inlet, Free outlet. Power rating (kW) does not include transmission losses. Performance ratings do not include the effects of appurtenances (accessories-belt cover, pulley & belt). FE<sub>1T</sub> / FE<sub>1S</sub> values are calculated in accordance with ANSI/AMCA Standard 208 and are based on default motor efficiencies (Direct Driven type). FE<sub>1T</sub> / FE<sub>1S</sub> values for fans with specific motors will vary slightly from those shown.



Model: AXV 710-110-6

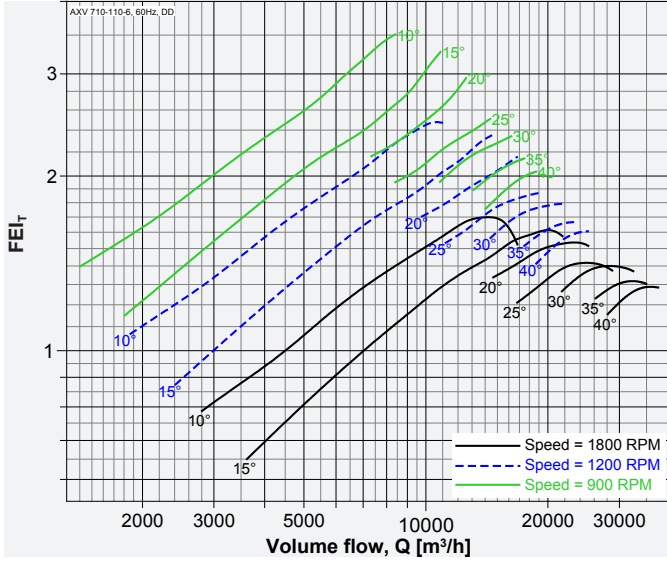

Model: AXV 710-150-5

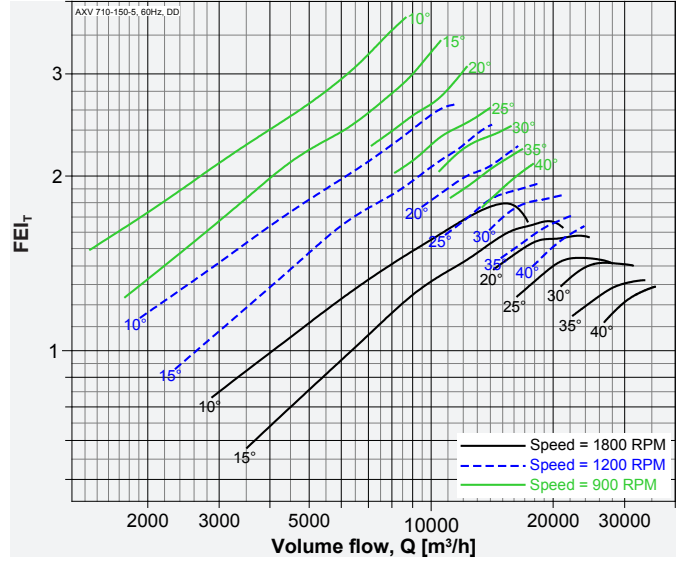

Model: AXV 710-150-10

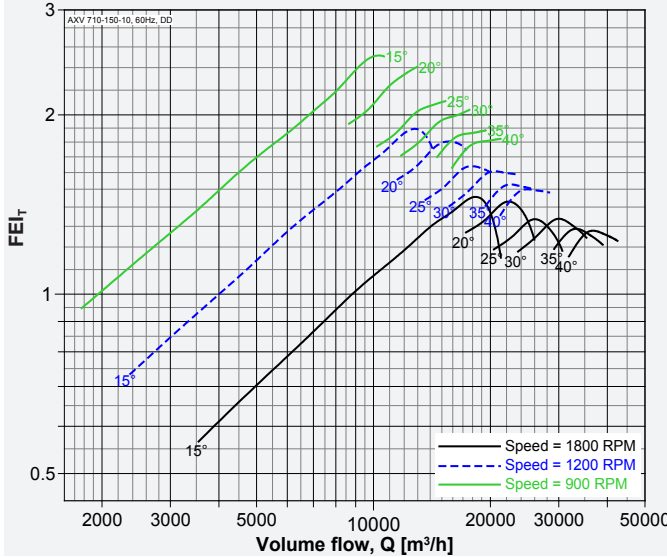

Model: AXV 710-250-7

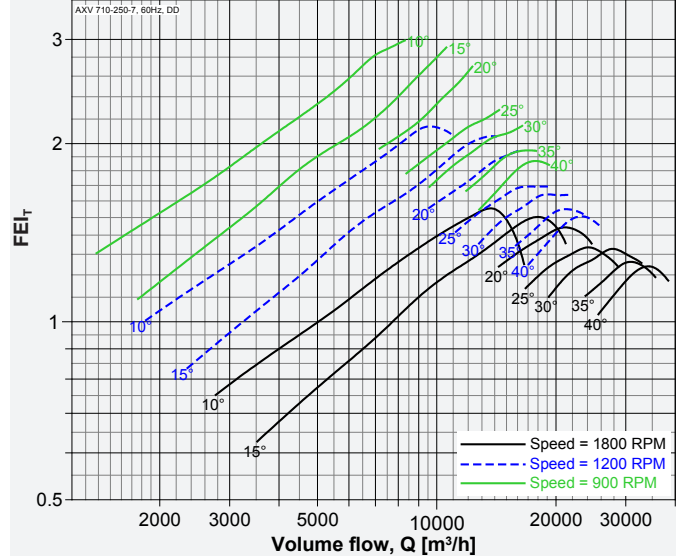

Model: AXV 710-250-9

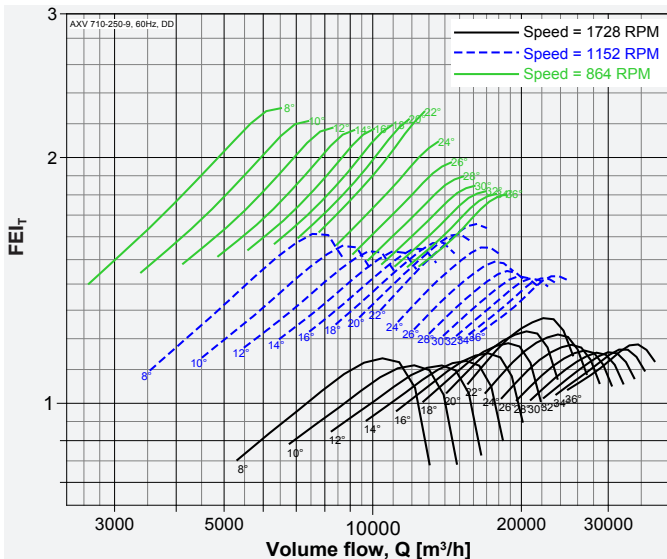

Model: AXV 710-250-14

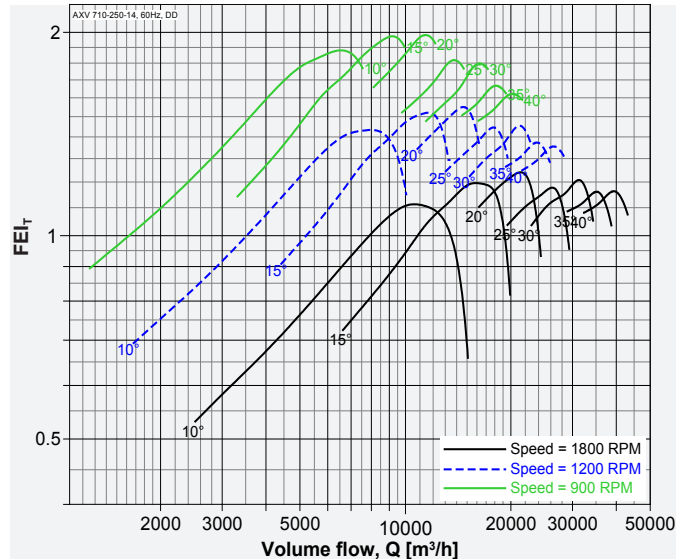

Performance of size 250 to 1250 certified is for installation type D - Ducted inlet, Ducted outlet, Performance of size 1400 to 2800 certified is for installation type A - Free inlet, Free outlet. Power rating (kW) does not include transmission losses. Performance ratings do not include the effects of appurtenances (accessories-belt cover, pulley & belt). FEI<sub>r</sub> / FEI<sub>s</sub> values are calculated in accordance with ANSI/AMCA Standard 208 and are based on default motor efficiencies (Direct Driven type). FEI<sub>r</sub> / FEI<sub>s</sub> values for fans with specific motors will vary slightly from those shown.



Model: AXV 800-150-5

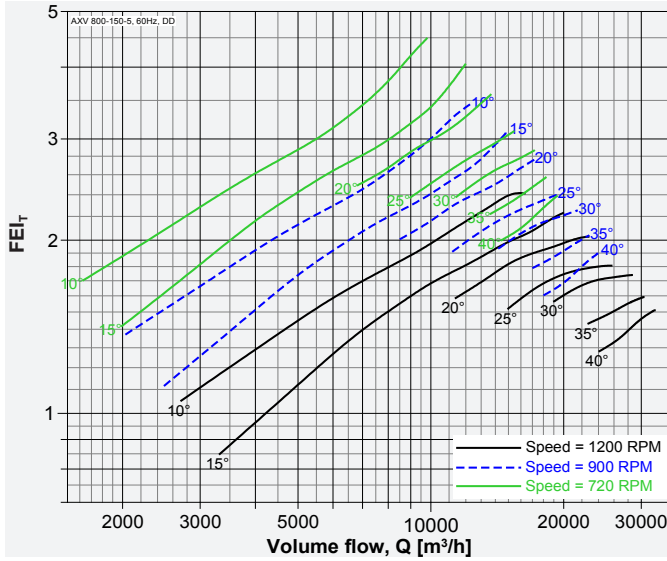

Model: AXV 800-150-10

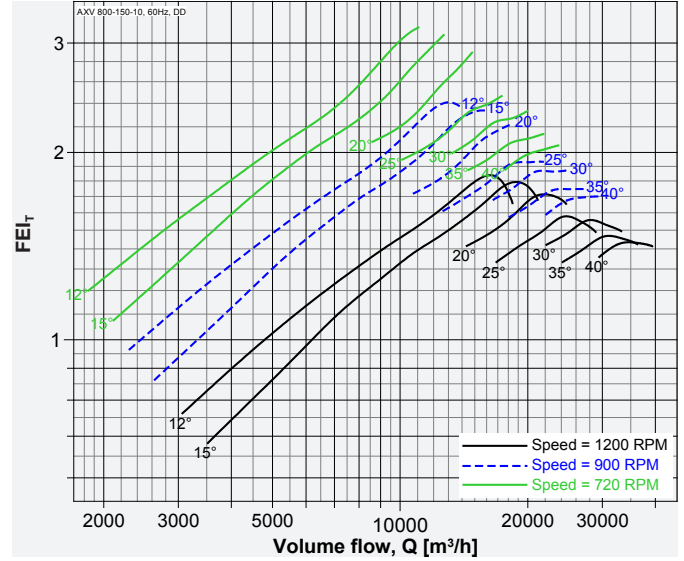

Model: AXV 800-250-7

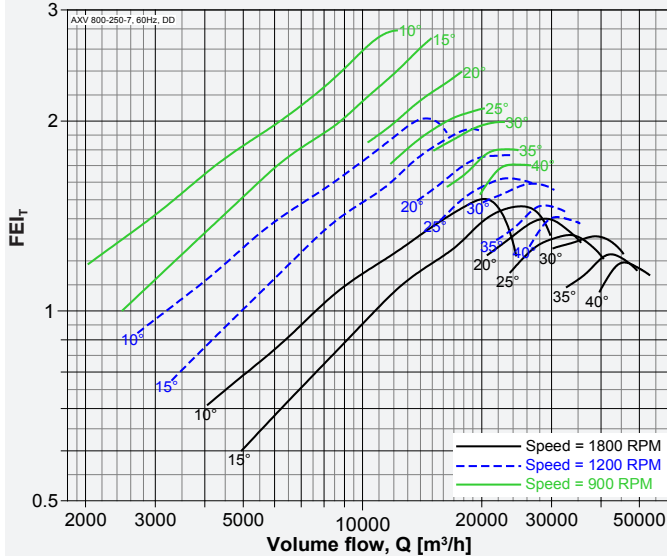

Model: AXV 800-250-9

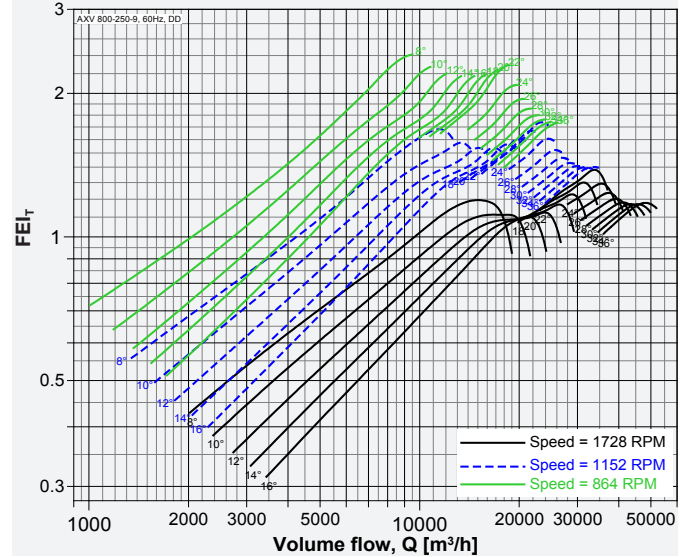

Model: AXV 800-250-14

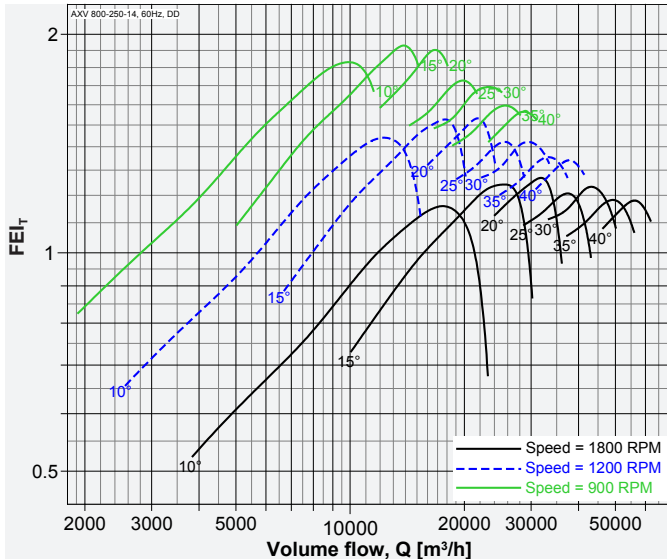

Model: AXV 900-250-7

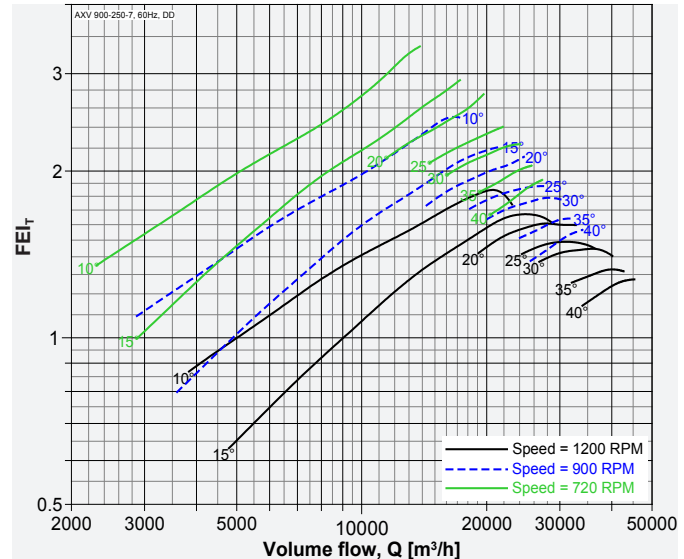

Performance of size 250 to 1250 certified is for installation type D - Ducted inlet, Ducted outlet, Performance of size 1400 to 2800 certified is for installation type A - Free inlet, Free outlet. Power rating (kW) does not include transmission losses. Performance ratings do not include the effects of appurtenances (accessories-belt cover, pulley & belt). FE<sub>1r</sub> / FE<sub>1s</sub> values are calculated in accordance with ANSI/AMCA Standard 208 and are based on default motor efficiencies (Direct Driven type). FE<sub>1r</sub> / FE<sub>1s</sub> values for fans with specific motors will vary slightly from those shown.





Model: AXV 900-250-14

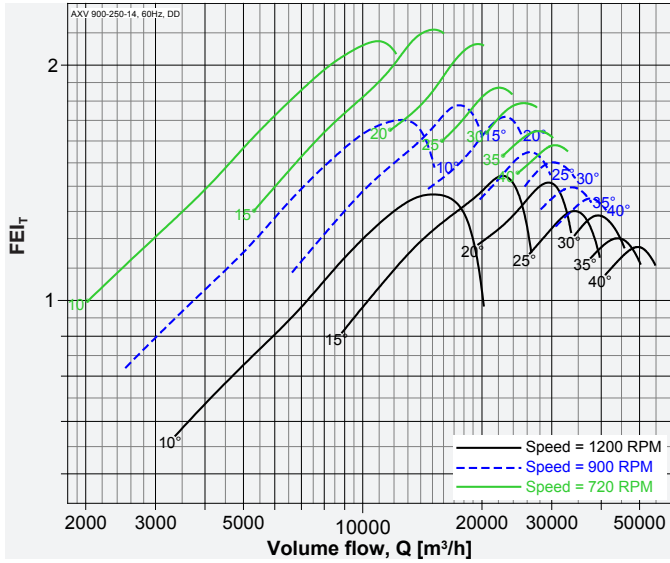

Model: AXV 900-300-10

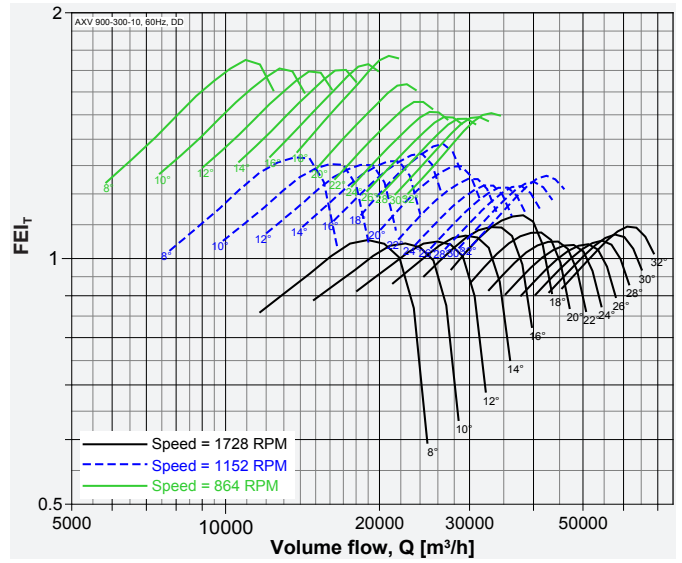

Model: AXV 1000-250-7

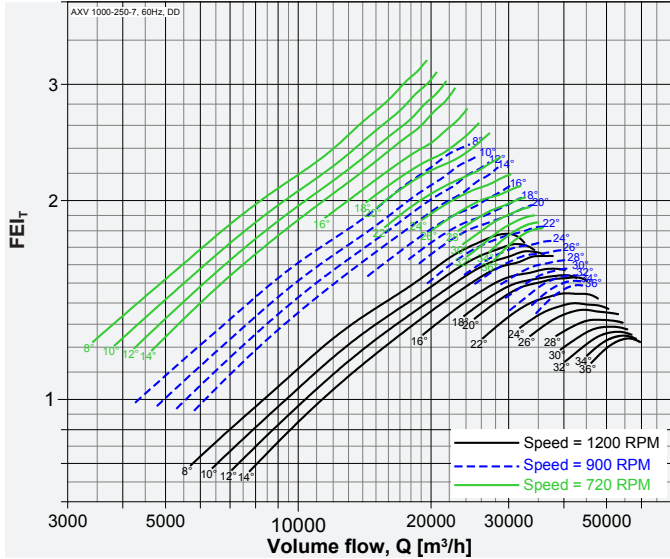

Model: AXV 1000-250-14

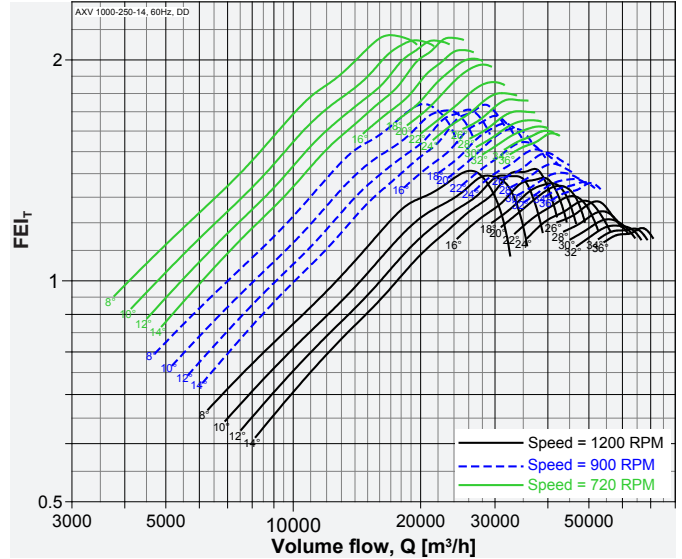

Model: AXV 1000-300-10

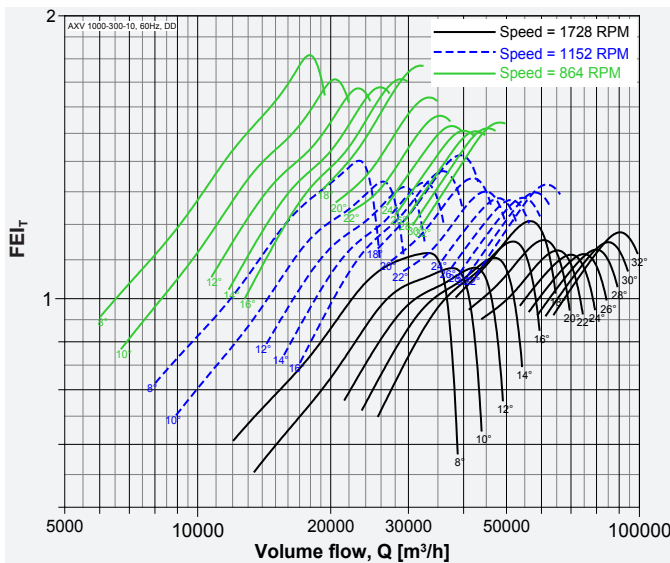

Model: AXV 1120-300-5

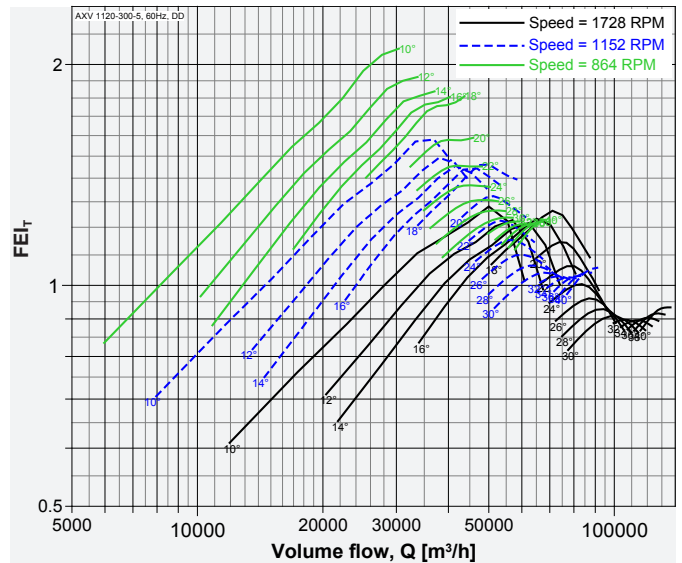

Performance of size 250 to 1250 certified is for installation type D - Ducted inlet, Ducted outlet, Performance of size 1400 to 2800 certified is for installation type A - Free inlet, Free outlet. Power rating (kW) does not include transmission losses. Performance ratings do not include the effects of appurtenances (accessories-belt cover, pulley & belt). FEI<sub>r</sub> / FEI<sub>s</sub> values are calculated in accordance with ANSI/AMCA Standard 208 and are based on default motor efficiencies (Direct Driven type). FEI<sub>r</sub> / FEI<sub>s</sub> values for fans with specific motors will vary slightly from those shown.



Model: AXV 1250-370-6

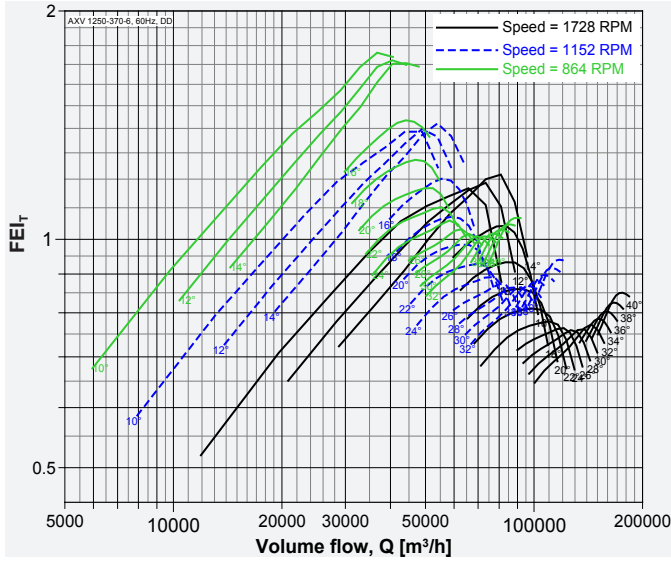

Model: AXV 1400-420-6

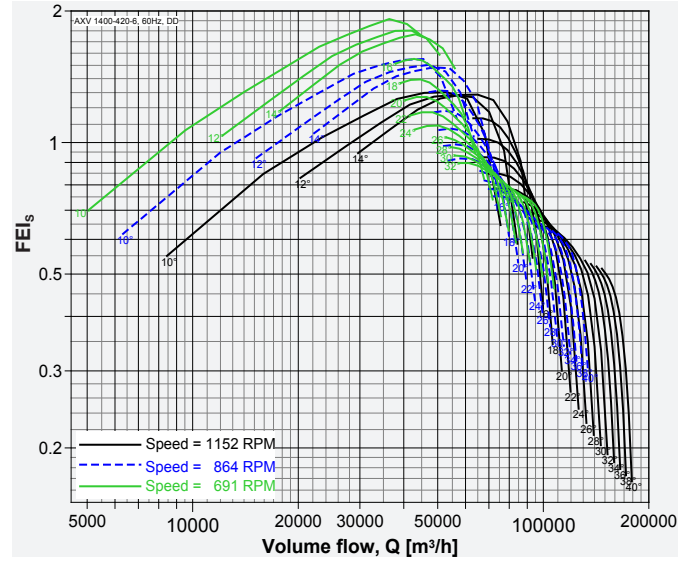

Model: AXV 1600-420-6

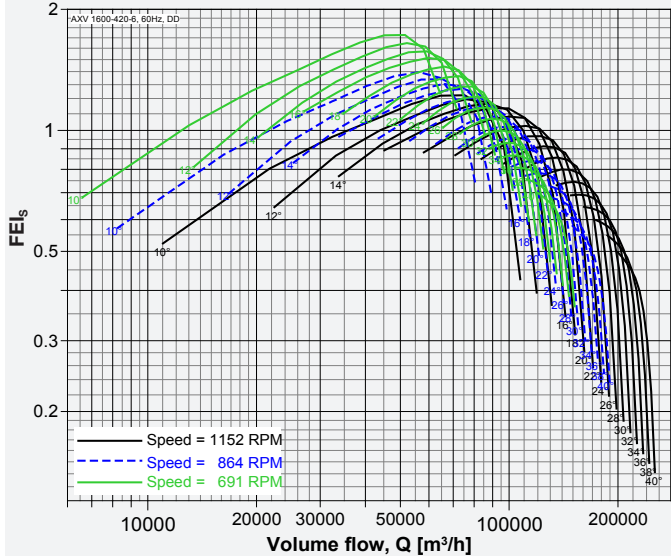

Model: AXV 1800-540-6

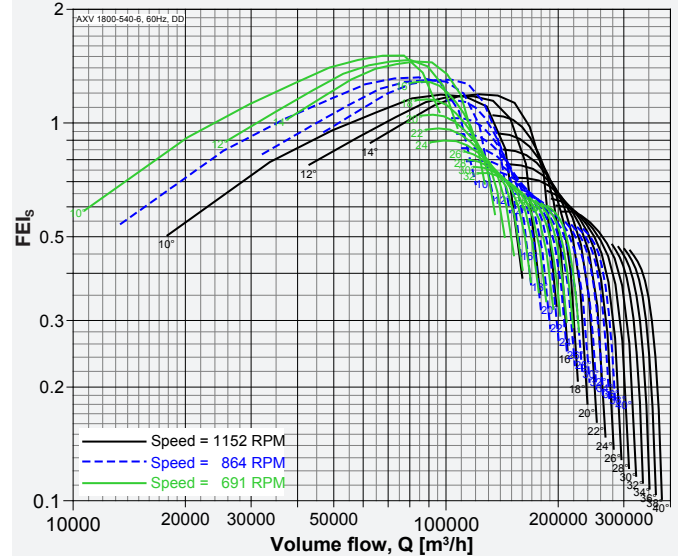

Model: AXV 2000-600-6

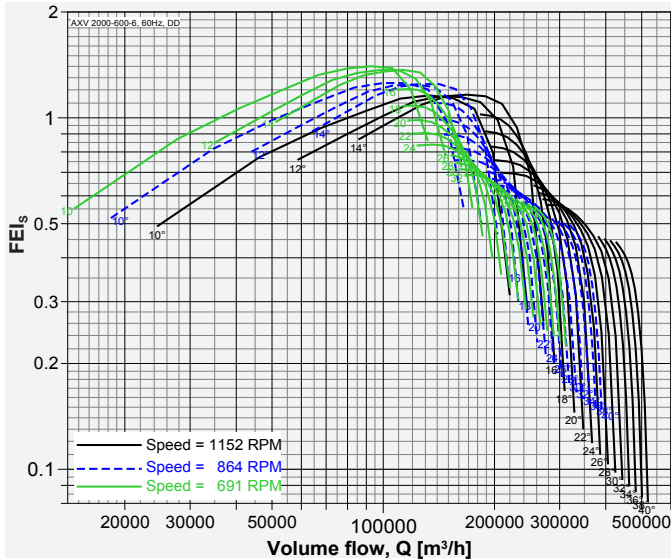

Model: AXV 2200-660-6

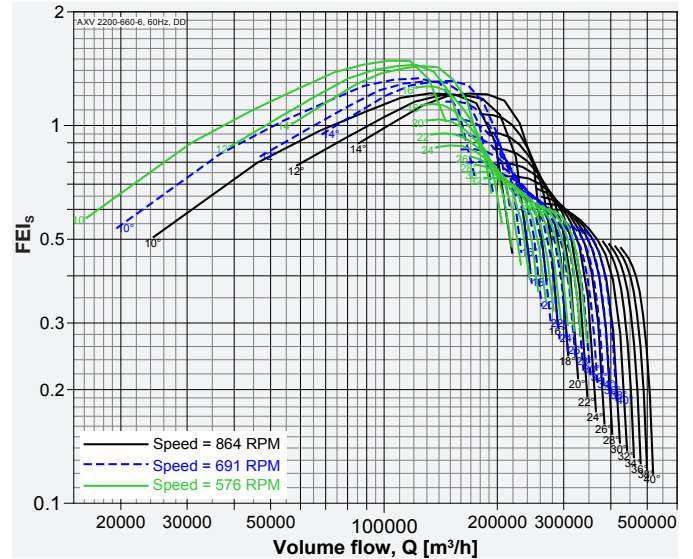

Performance of size 250 to 1250 certified is for installation type D - Ducted inlet, Ducted outlet, Performance of size 1400 to 2800 certified is for installation type A - Free inlet, Free outlet. Power rating (kW) does not include transmission losses. Performance ratings do not include the effects of appurtenances (accessories-belt cover, pulley & belt). FEI<sub>T</sub> / FEI<sub>S</sub> values are calculated in accordance with ANSI/AMCA Standard 208 and are based on default motor efficiencies (Direct Driven type). FEI<sub>T</sub> / FEI<sub>S</sub> values for fans with specific motors will vary slightly from those shown.



Model: AXV 2400-720-6

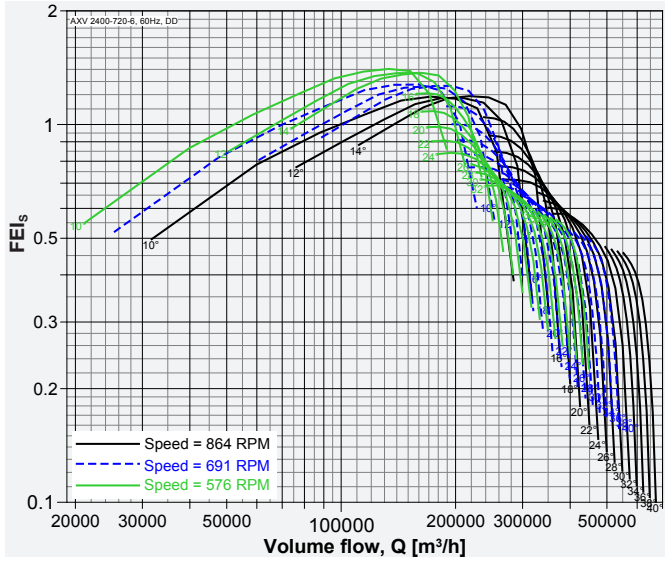

Model: AXV 2500-750-6

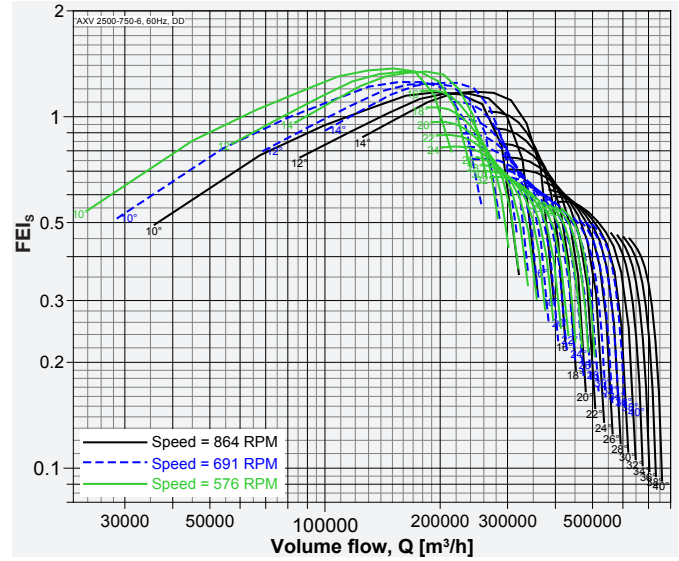

Model: AXV 2600-780-6

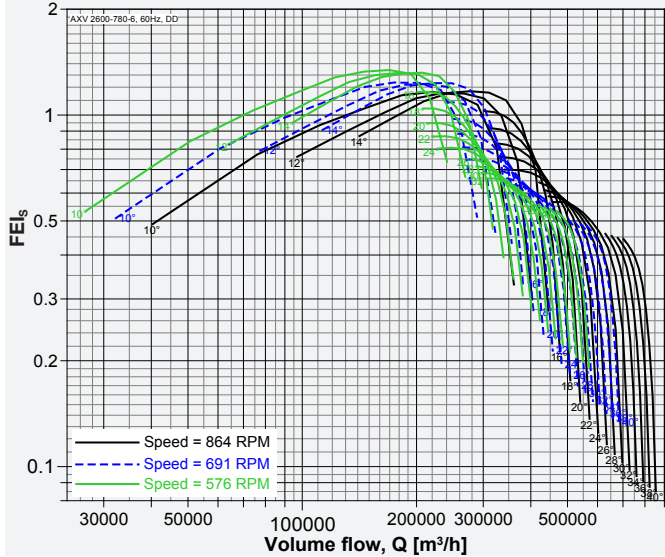

Model: AXV 2800-840-6

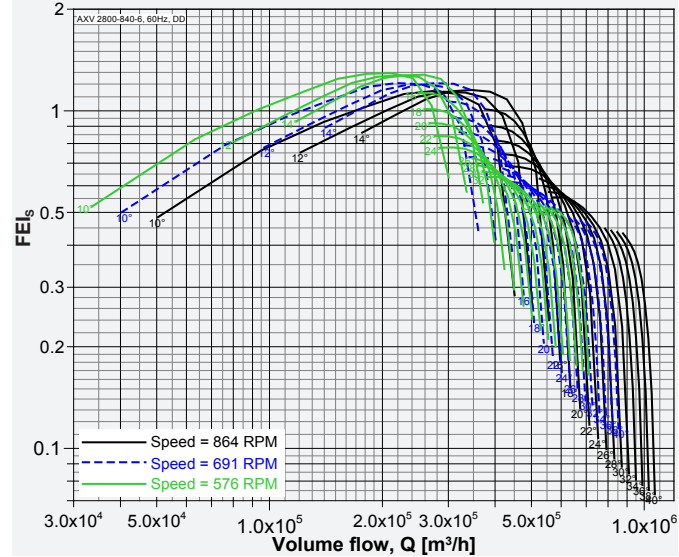

Performance of size 250 to 1250 certified is for installation type D - Ducted inlet, Ducted outlet, Performance of size 1400 to 2800 certified is for installation type A - Free inlet, Free outlet. Power rating (kW) does not include transmission losses. Performance ratings do not include the effects of appurtenances (accessories-belt cover, pulley & belt). FEI<sub>1</sub> / FEI<sub>s</sub> values are calculated in accordance with ANSI/AMCA Standard 208 and are based on default motor efficiencies (Direct Driven type). FEI<sub>1</sub> / FEI<sub>s</sub> values for fans with specific motors will vary slightly from those shown.



Belt Driven Models, Size from 250 to 2800, 60Hz

Model: AXV 250-110-3

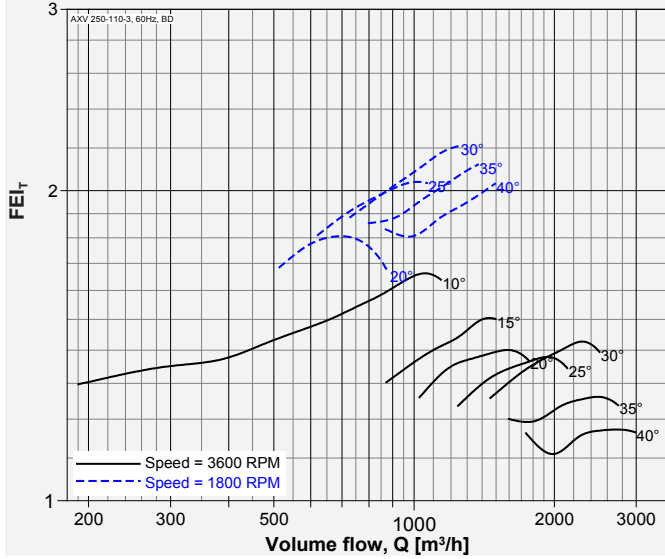

Model: AXV 250-110-6

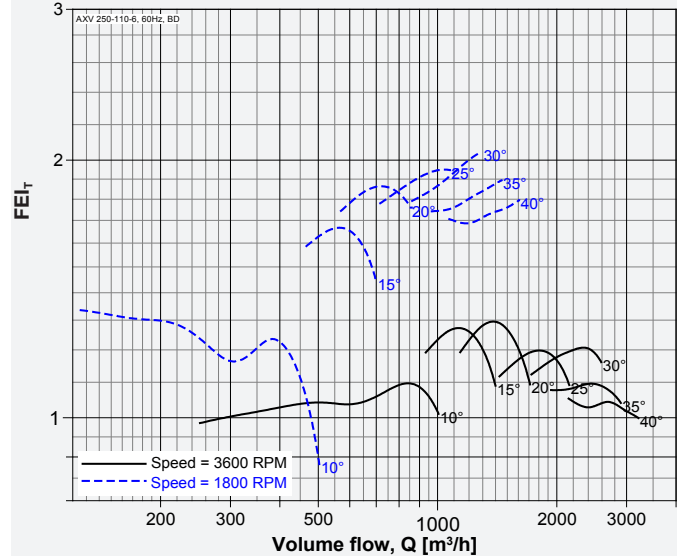

Model: AXV 280-110-3

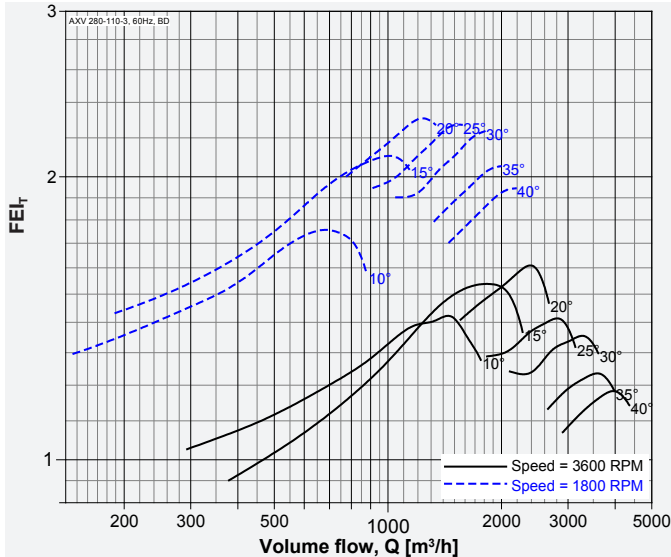

Model: AXV 280-110-6

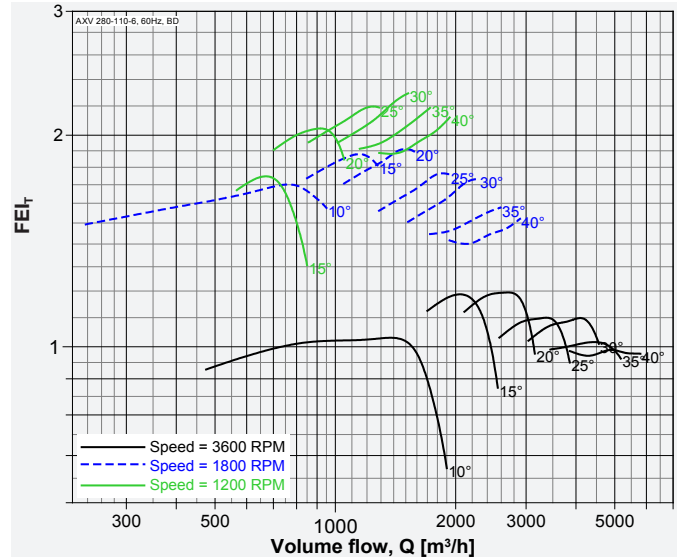

Model: AXV 315-110-3

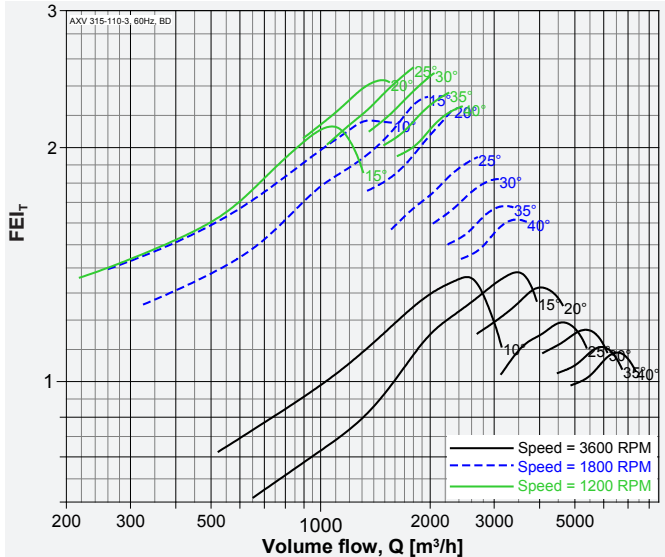

Model: AXV 315-110-6

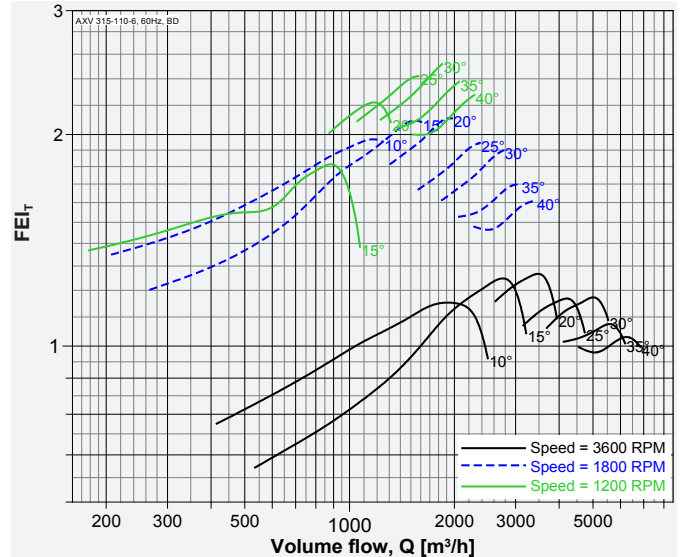

Performance of size 250 to 1250 certified is for installation type D - Ducted inlet, Ducted outlet, Performance of size 1400 to 2800 certified is for installation type A - Free inlet, Free outlet. Power rating (kW) does not include transmission losses. Performance ratings do not include the effects of appurtenances (accessories-belt cover, pulley & belt). FEI<sub>T</sub> / FEI<sub>S</sub> values are calculated in accordance with ANSI/AMCA Standard 208 and are based on default motor efficiencies (Belt Driven type). FEI<sub>T</sub> / FEI<sub>S</sub> values for fans with specific motors will vary slightly from those shown.



Model: AXV 355-110-3

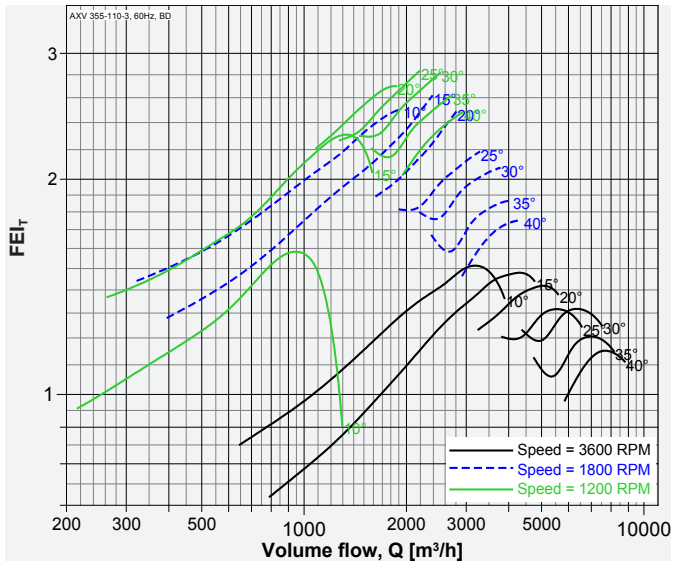

Model: AXV 355-110-6

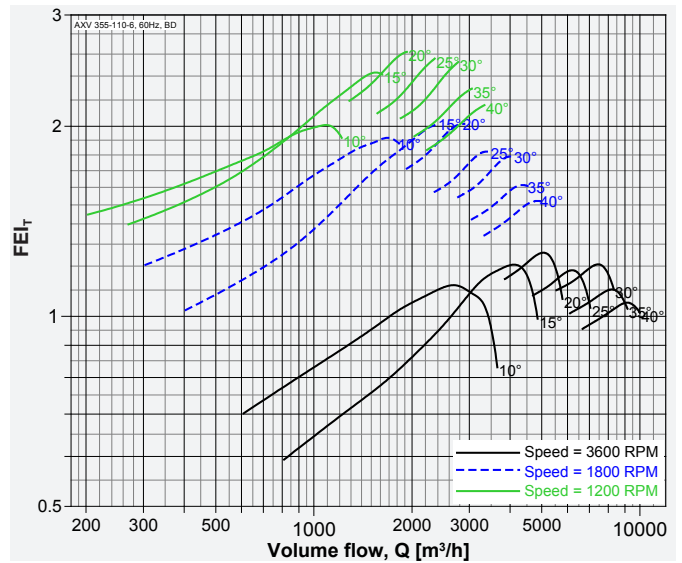

Model: AXV 355-150-7

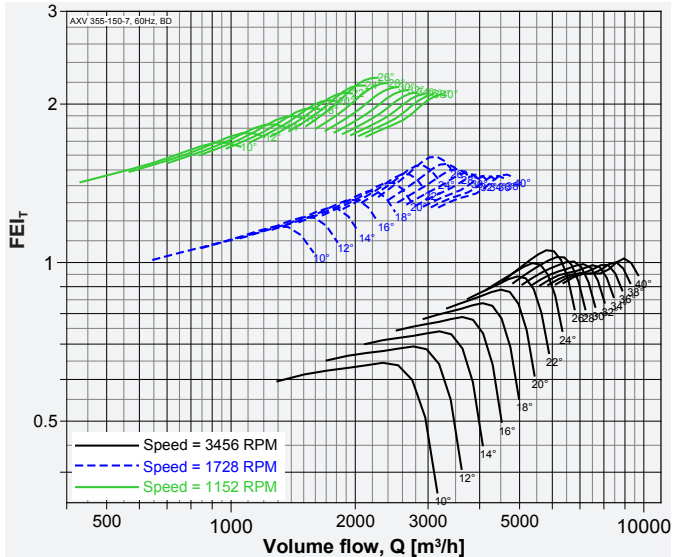

Model: AXV 400-110-3

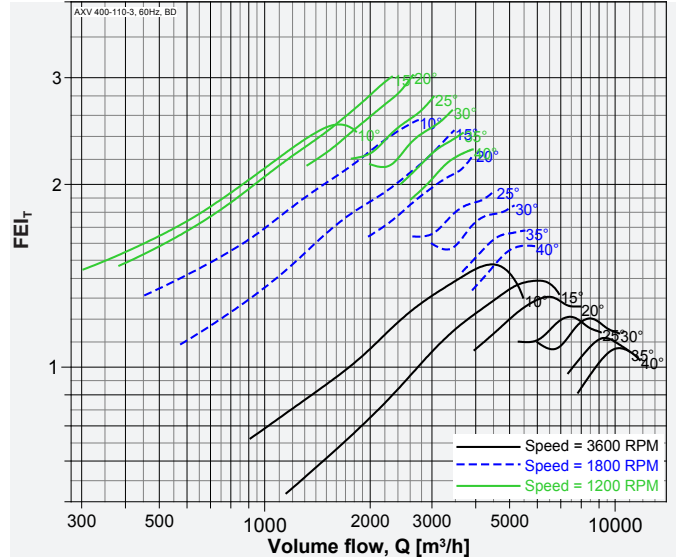

Model: AXV 400-110-6

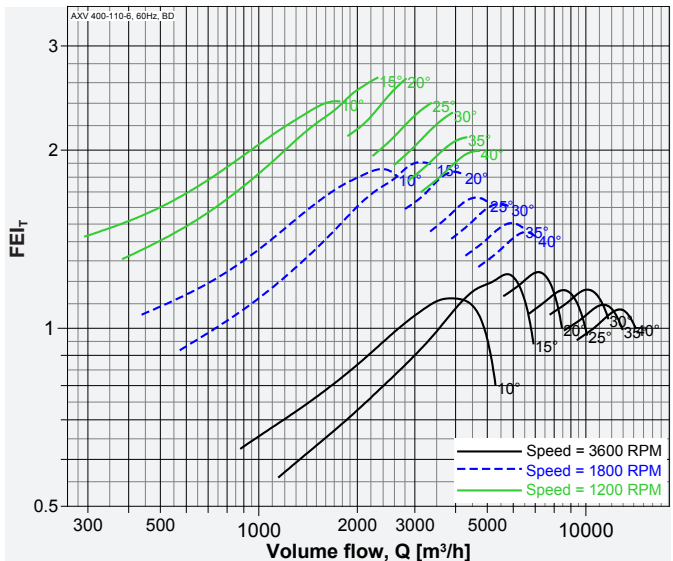

Model: AXV 400-150-5

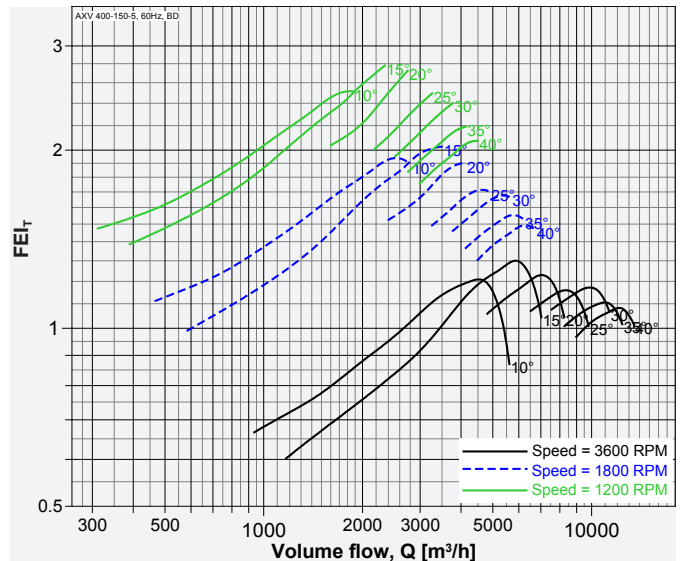

Performance of size 250 to 1250 certified is for installation type D - Ducted inlet, Ducted outlet, Performance of size 1400 to 2800 certified is for installation type A - Free inlet, Free outlet. Power rating (kW) does not include transmission losses. Performance ratings do not include the effects of appurtenances (accessories-belt cover, pulley & belt). FEI<sub>r</sub> / FEI<sub>s</sub> values are calculated in accordance with ANSI/AMCA Standard 208 and are based on default motor efficiencies (Belt Driven type). FEI<sub>r</sub> / FEI<sub>s</sub> values for fans with specific motors will vary slightly from those shown.



Model: AXV 400-150-7

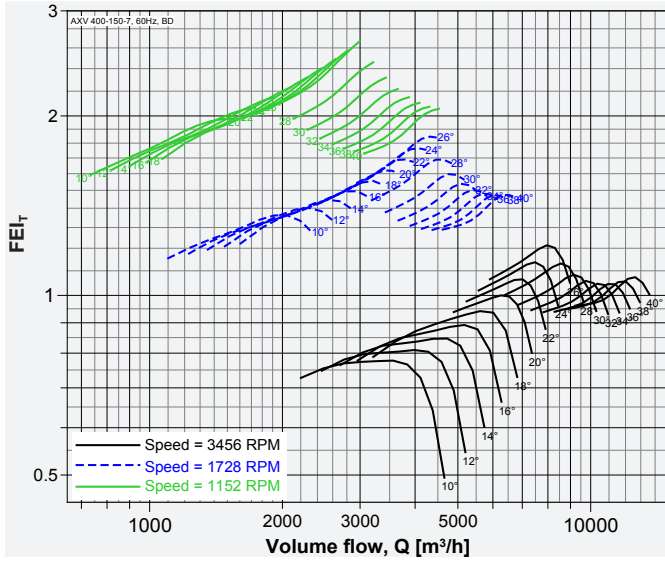

Model: AXV 400-150-10

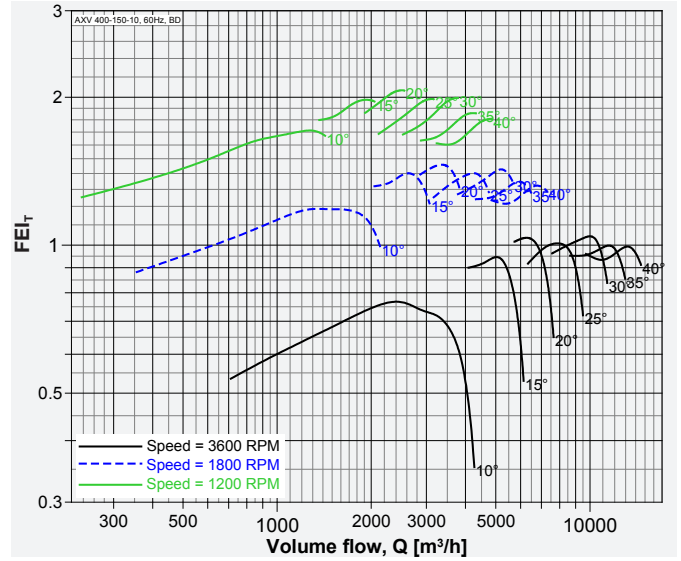

Model: AXV 450-110-3

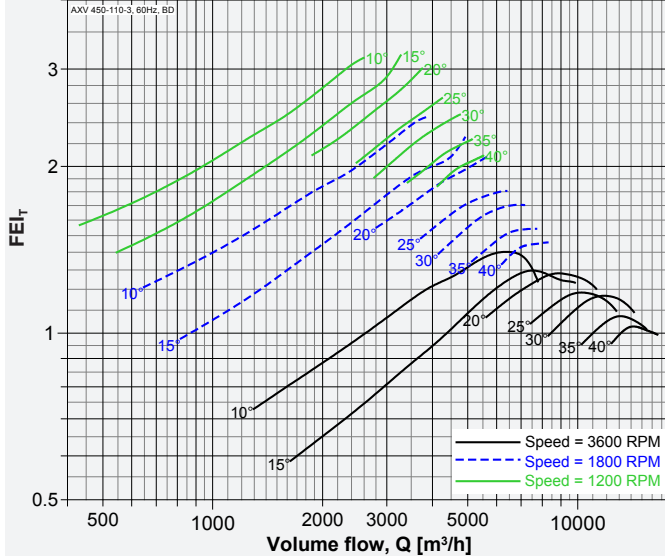

Model: AXV 450-110-6

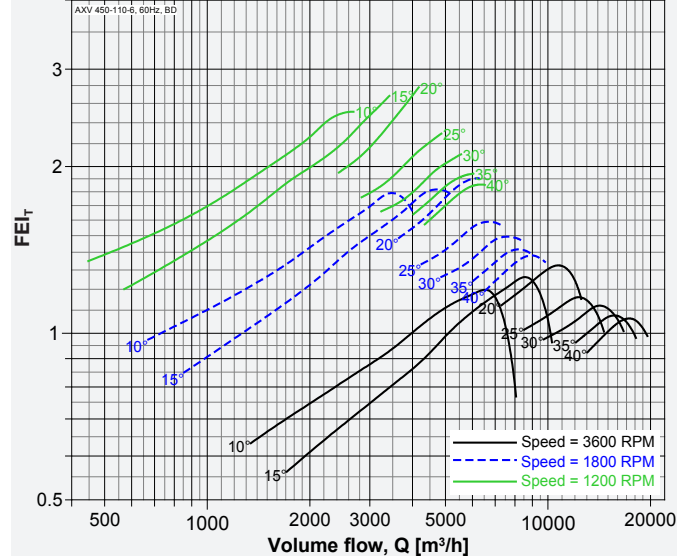

Model: AXV 450-150-5

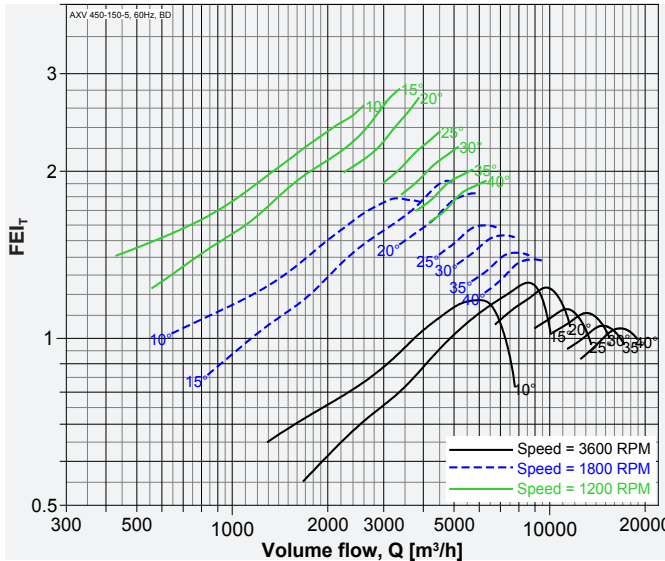

Model: AXV 450-150-7

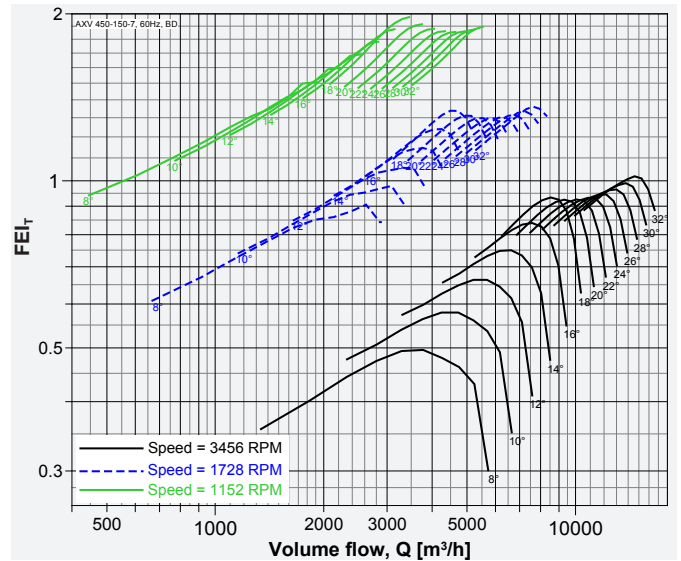

Performance of size 250 to 1250 certified is for installation type D - Ducted inlet, Ducted outlet, Performance of size 1400 to 2800 certified is for installation type A - Free inlet, Free outlet. Power rating (kW) does not include transmission losses. Performance ratings do not include the effects of appurtenances (accessories-belt cover, pulley & belt). FEI<sub>t</sub> / FEI<sub>s</sub> values are calculated in accordance with ANSI/AMCA Standard 208 and are based on default motor efficiencies (Belt Driven type). FEI<sub>t</sub> / FEI<sub>s</sub> values for fans with specific motors will vary slightly from those shown.



Model: AXV 450-150-10

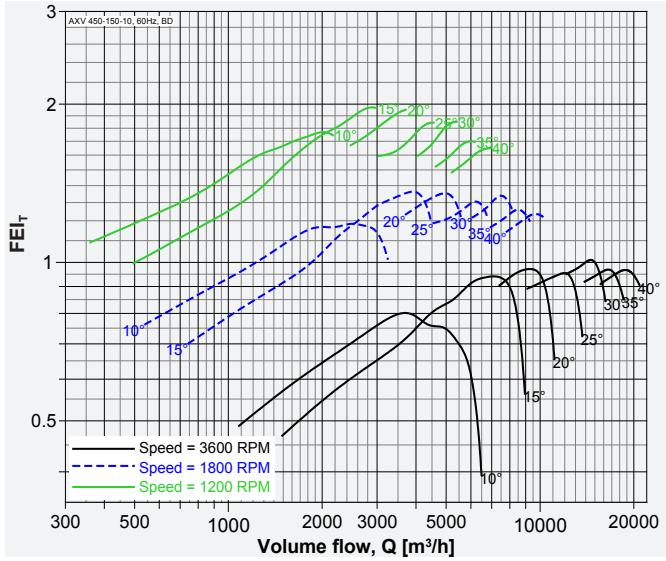

Model: AXV 500-110-3

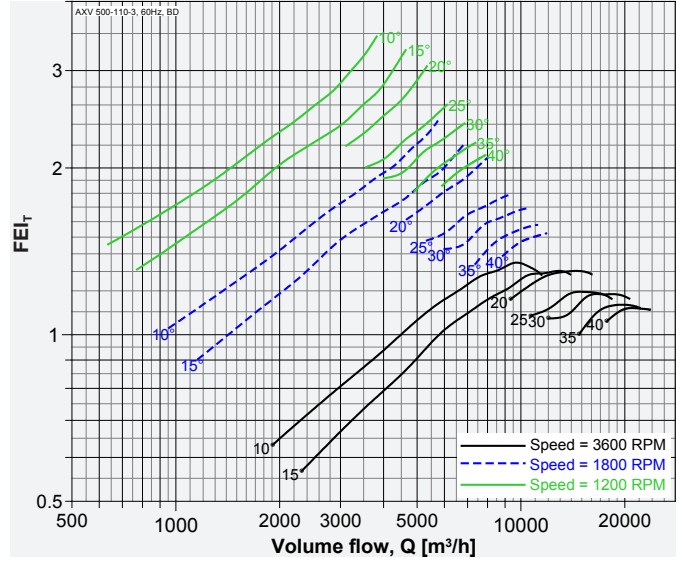

Model: AXV 500-110-6

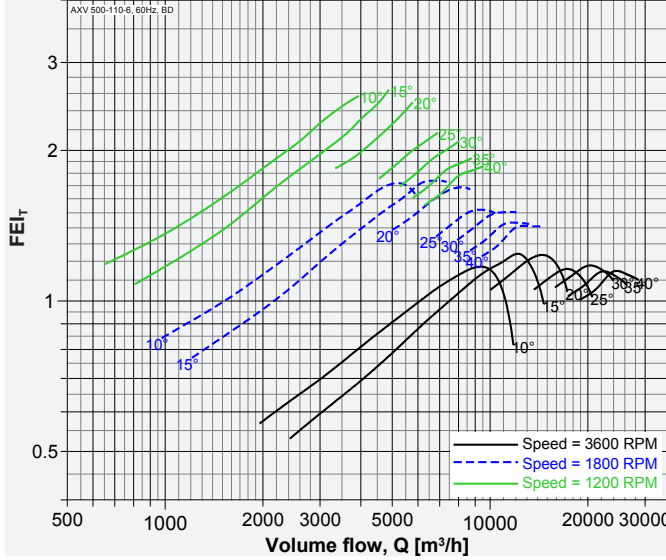

Model: AXV 500-150-5

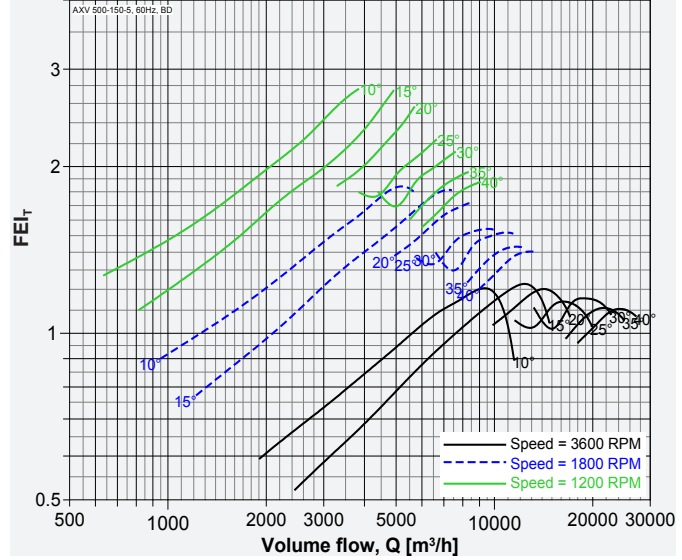

Model: AXV 500-150-7

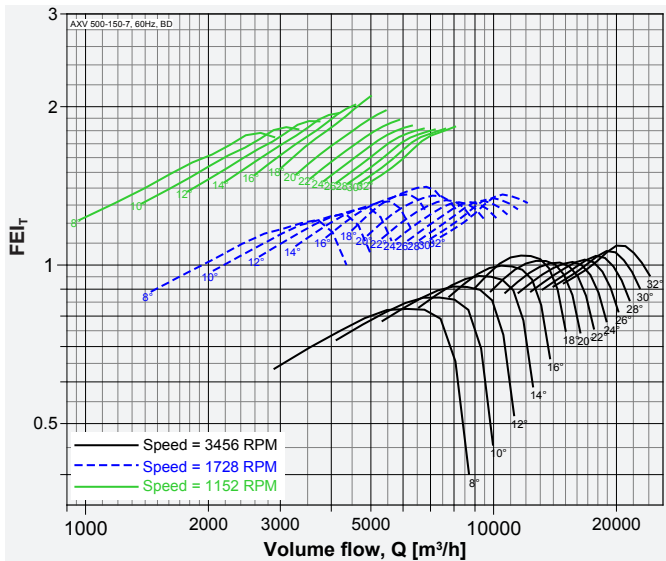

Model: AXV 500-150-10

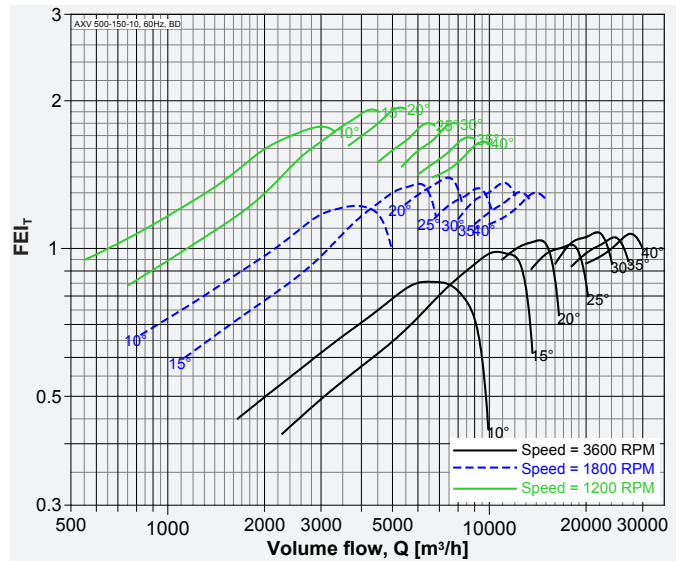

Performance of size 250 to 1250 certified is for installation type D - Ducted inlet, Ducted outlet, Performance of size 1400 to 2800 certified is for installation type A - Free inlet, Free outlet. Power rating (kW) does not include transmission losses. Performance ratings do not include the effects of appurtenances (accessories-belt cover, pulley & belt). FEI<sub>T</sub> / FEI<sub>S</sub> values are calculated in accordance with ANSI/AMCA Standard 208 and are based on default motor efficiencies (Belt Driven type). FEI<sub>T</sub> / FEI<sub>S</sub> values for fans with specific motors will vary slightly from those shown.



Model: AXV 500-250-7

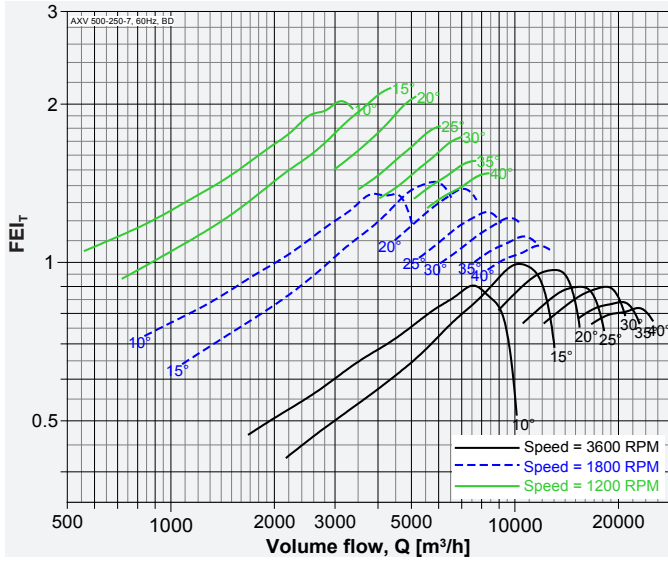

Model: AXV 560-110-3

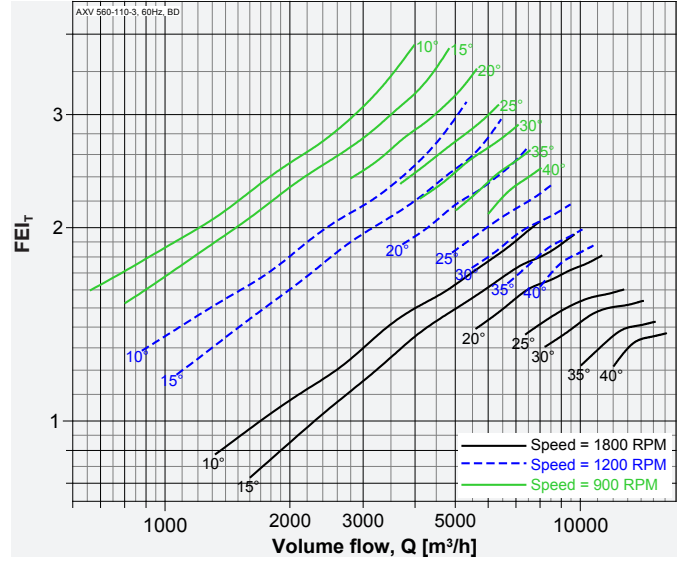

Model: AXV 560-110-6

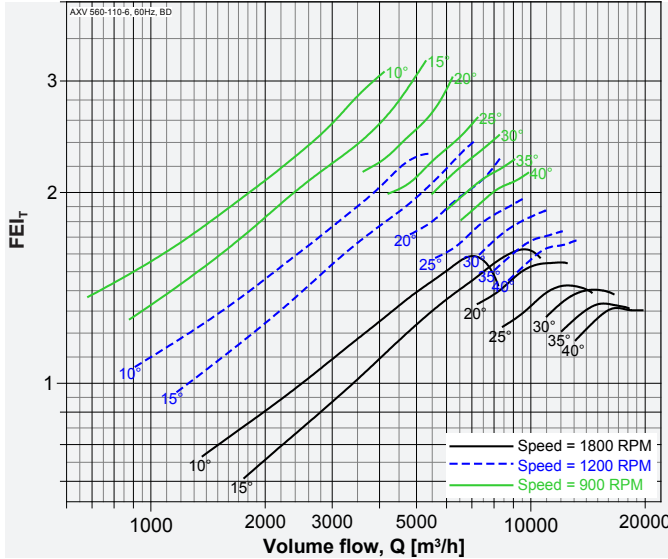

Model: AXV 560-150-5

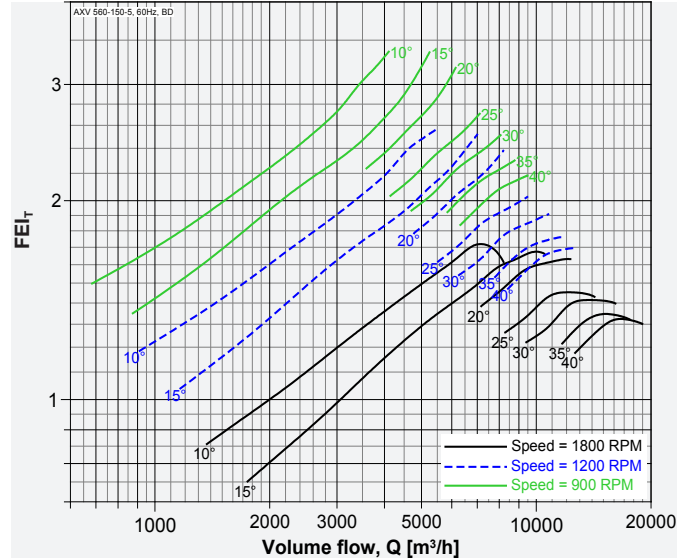

Model: AXV 560-150-10

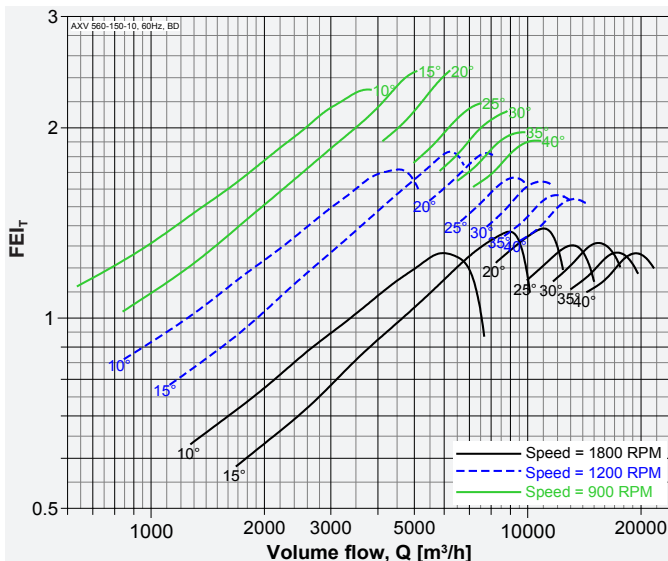

Model: AXV 560-200-9

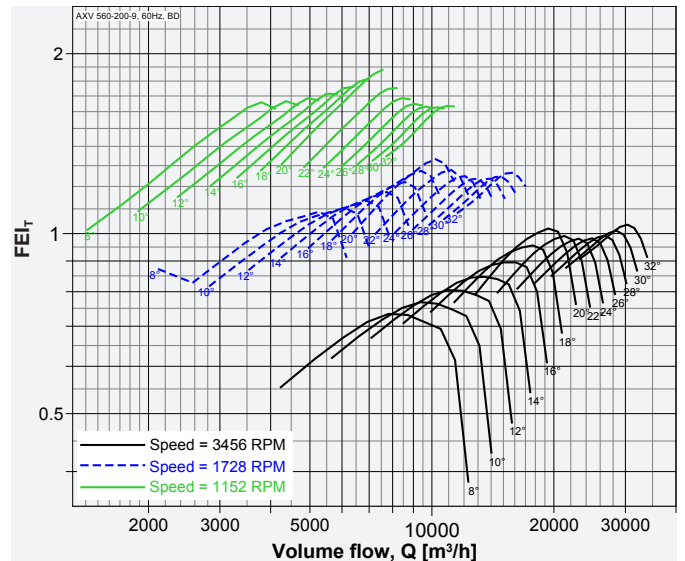

Performance of size 250 to 1250 certified is for installation type D - Ducted inlet, Ducted outlet, Performance of size 1400 to 2800 certified is for installation type A - Free inlet, Free outlet. Power rating (kW) does not include transmission losses. Performance ratings do not include the effects of appurtenances (accessories-belt cover, pulley & belt). FE<sub>1</sub> / FE<sub>5</sub> values are calculated in accordance with ANSI/AMCA Standard 208 and are based on default motor efficiencies (Belt Driven type). FE<sub>1</sub> / FE<sub>5</sub> values for fans with specific motors will vary slightly from those shown.





Model: AXV 560-250-7

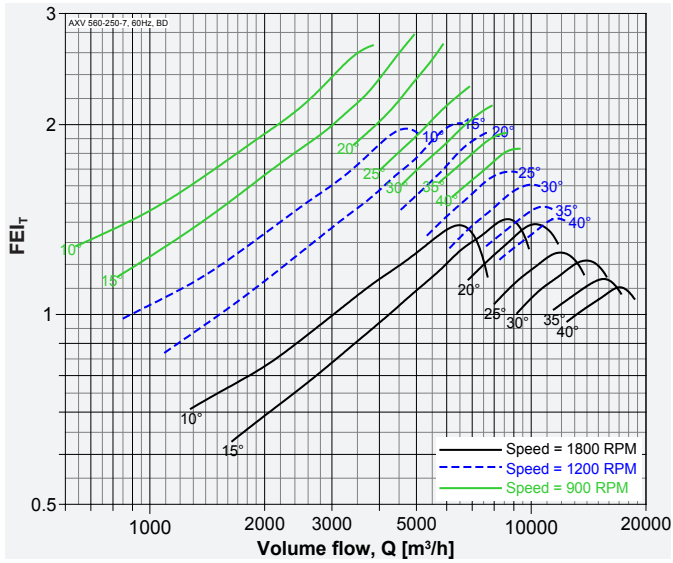

Model: AXV 560-250-14

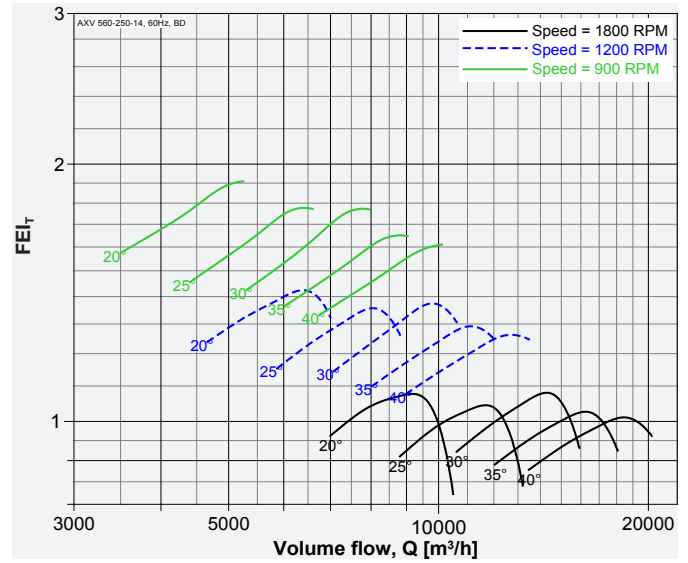

Model: AXV 630-110-3

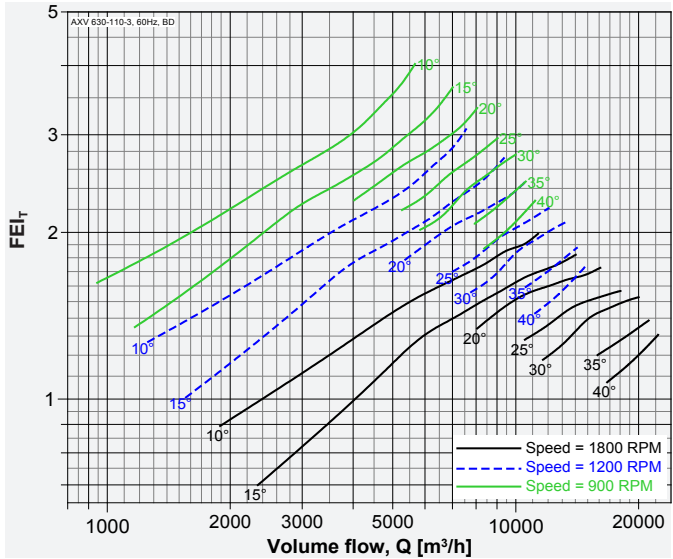

Model: AXV 630-110-6

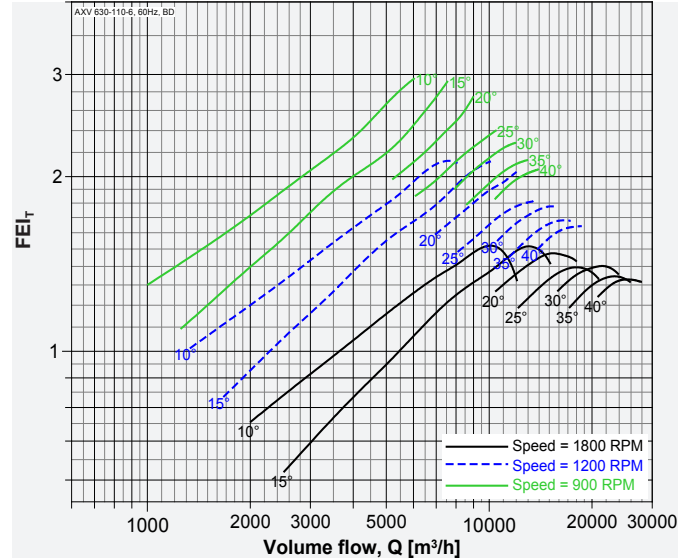

Model: AXV 630-150-5

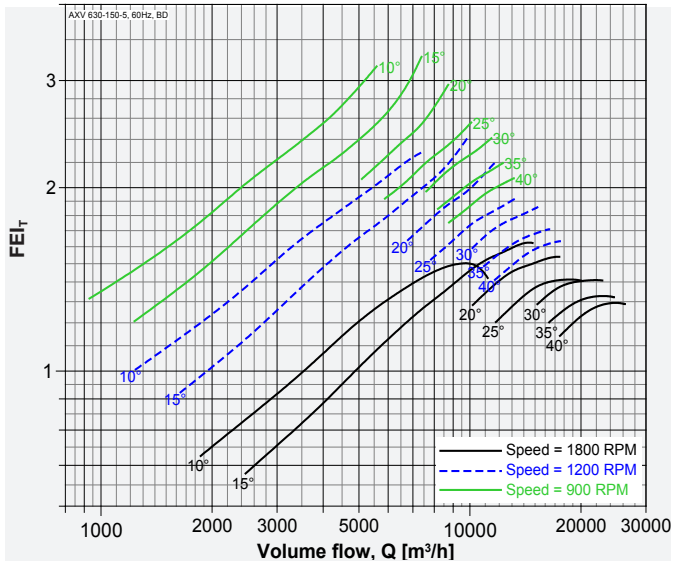

Model: AXV 630-150-10

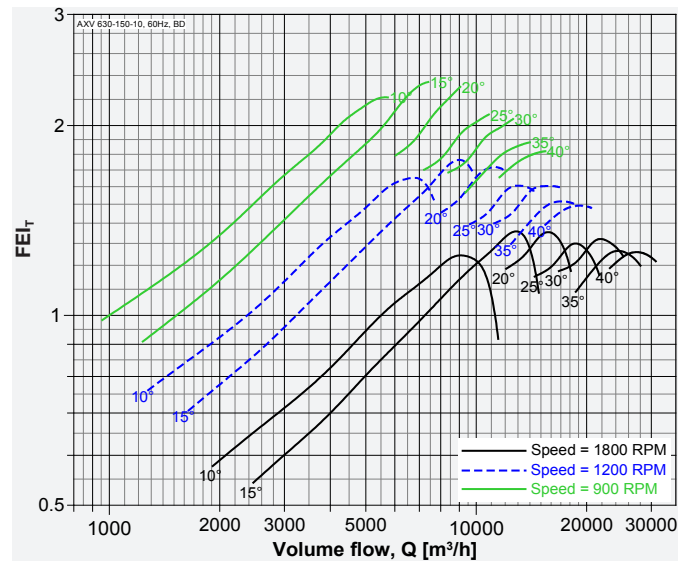

Performance of size 250 to 1250 certified is for installation type D - Ducted inlet, Ducted outlet, Performance of size 1400 to 2800 certified is for installation type A - Free inlet, Free outlet. Power rating (kW) does not include transmission losses. Performance ratings do not include the effects of appurtenances (accessories-belt cover, pulley & belt). FEI<sub>T</sub> / FEI<sub>S</sub> values are calculated in accordance with ANSI/AMCA Standard 208 and are based on default motor efficiencies (Belt Driven type). FEI<sub>T</sub> / FEI<sub>S</sub> values for fans with specific motors will vary slightly from those shown.



Model: AXV 630-200-9

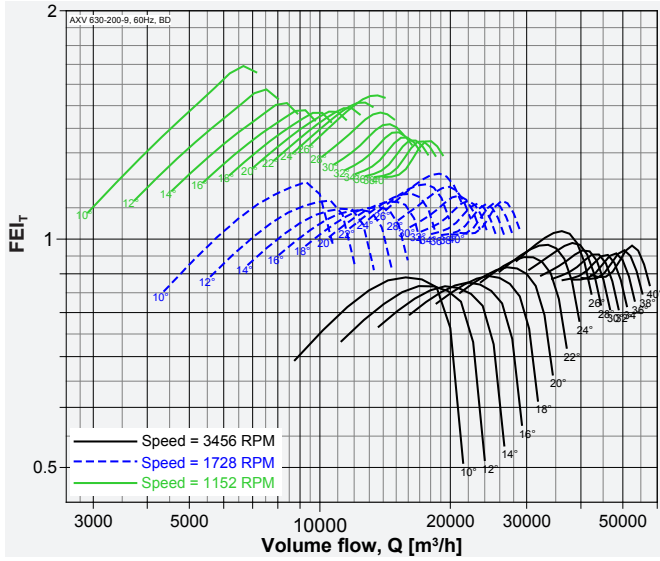

Model: AXV 630-250-7

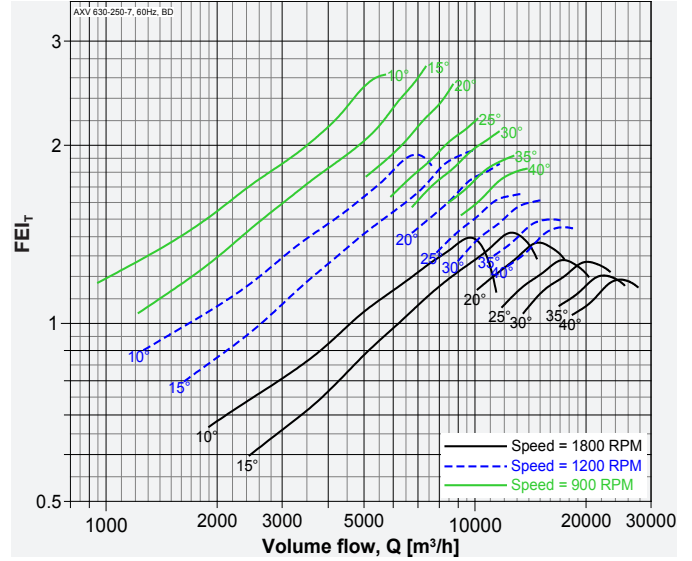

Model: AXV 630-250-14

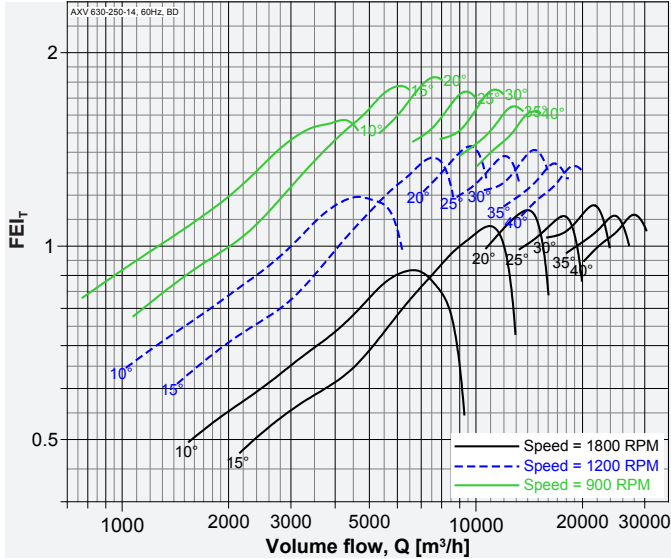

Model: AXV 710-110-3

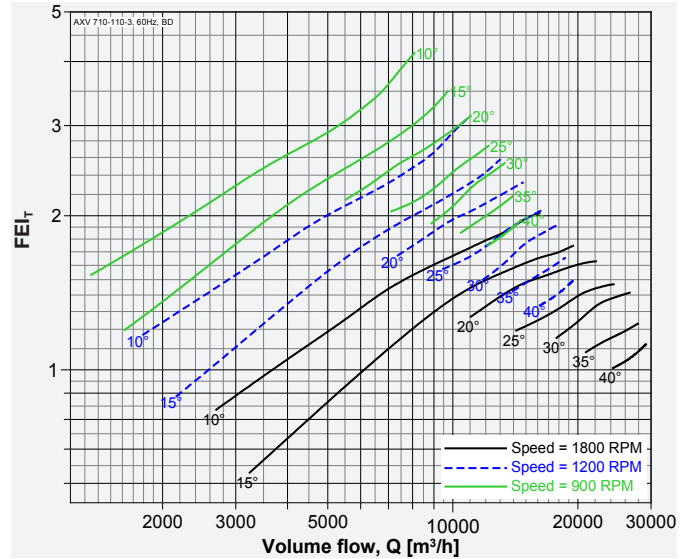

Model: AXV 710-110-6

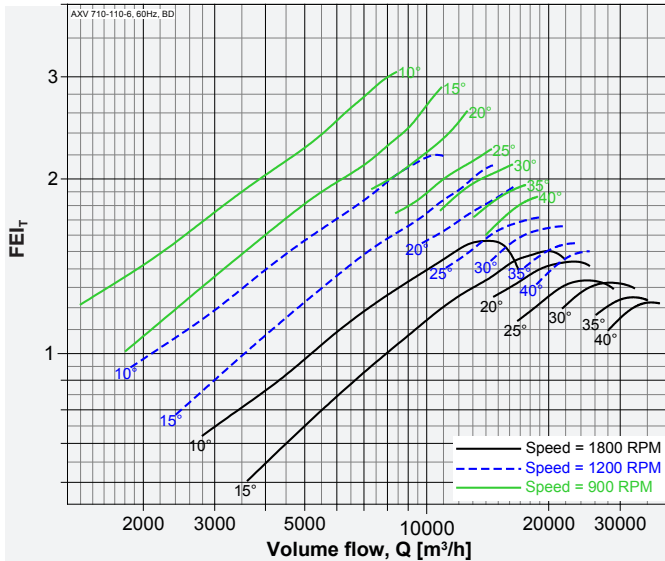

Model: AXV 710-150-5

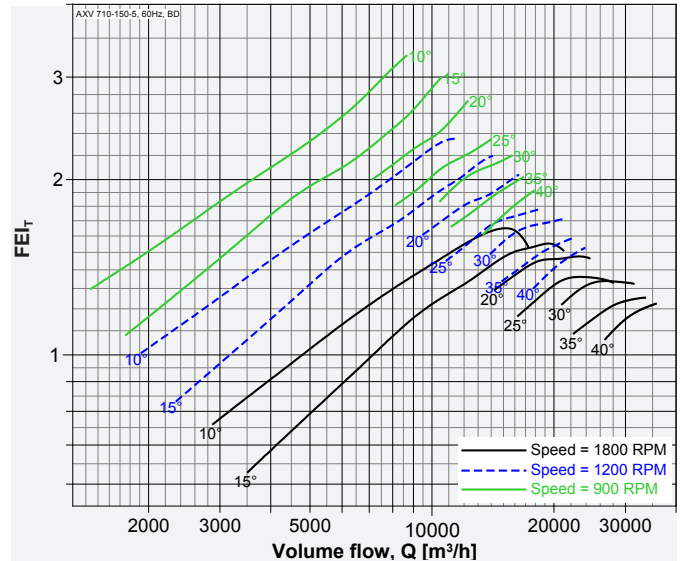

Performance of size 250 to 1250 certified is for installation type D - Ducted inlet, Ducted outlet, Performance of size 1400 to 2800 certified is for installation type A - Free inlet, Free outlet. Power rating (kW) does not include transmission losses. Performance ratings do not include the effects of appurtenances (accessories-belt cover, pulley & belt). FEI<sub>t</sub> / FEI<sub>s</sub> values are calculated in accordance with ANSI/AMCA Standard 208 and are based on default motor efficiencies (Belt Driven type). FEI<sub>t</sub> / FEI<sub>s</sub> values for fans with specific motors will vary slightly from those shown.



Model: AXV 710-150-10

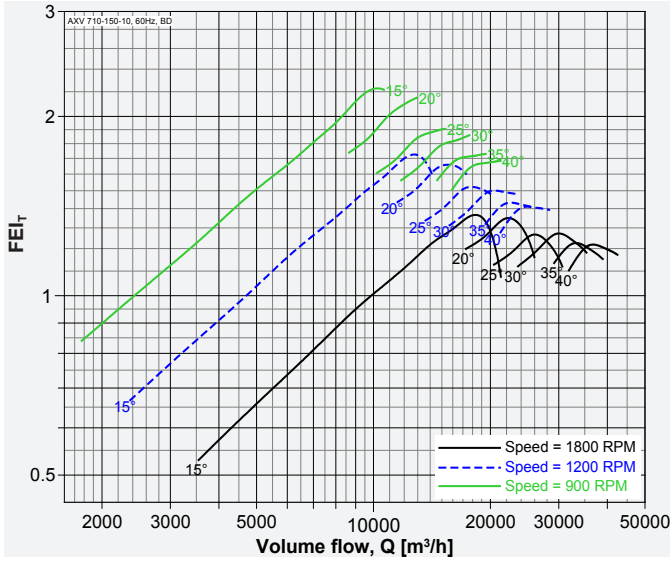

Model: AXV 710-250-7

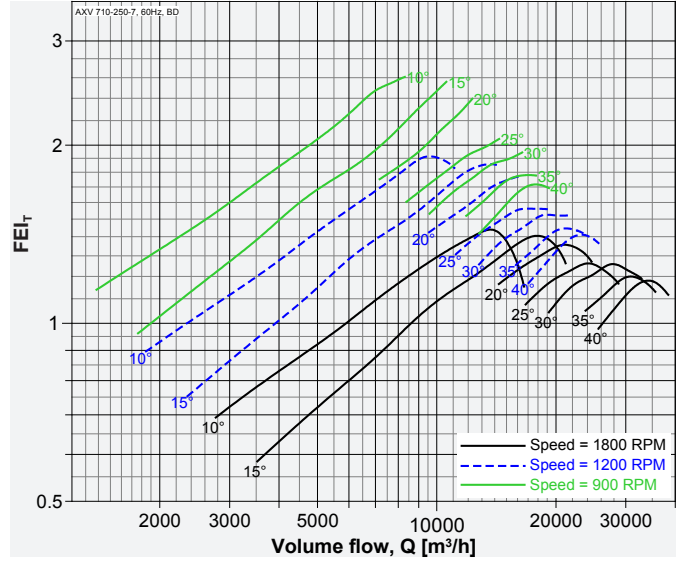

Model: AXV 710-250-9

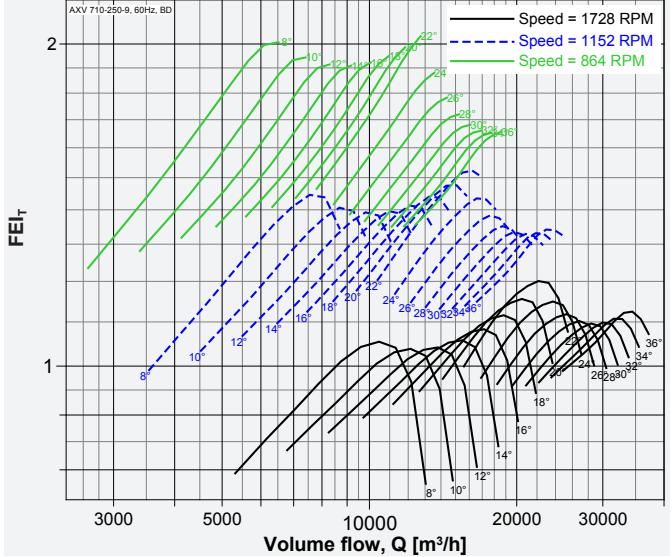

Model: AXV 710-250-14

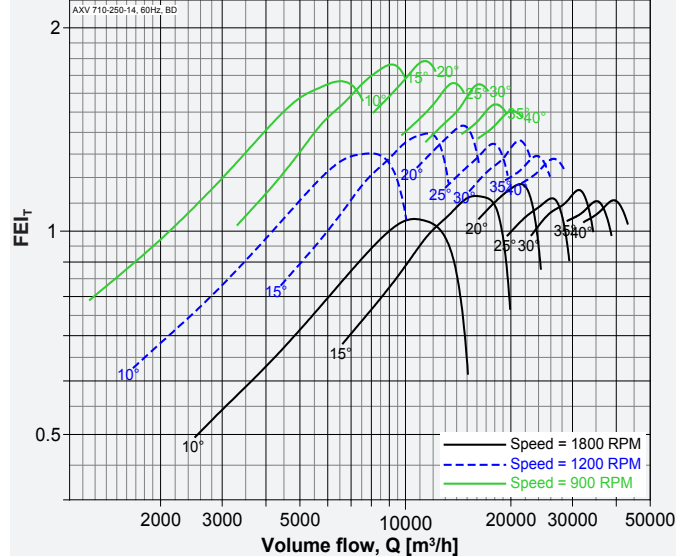

Model: AXV 800-150-5

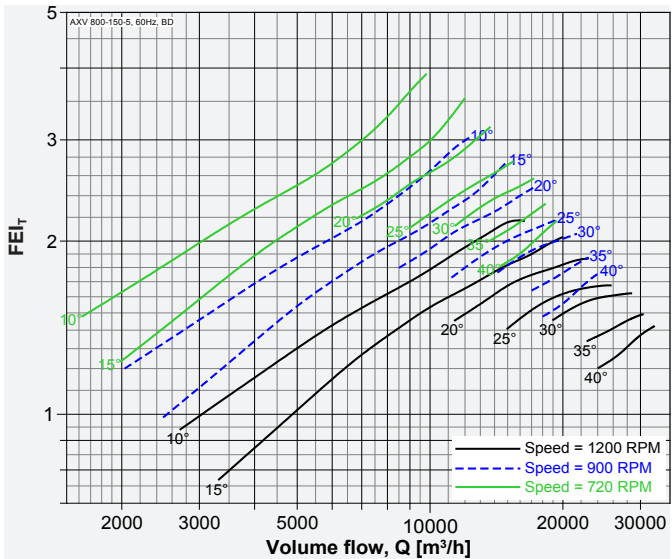

Model: AXV 800-150-10

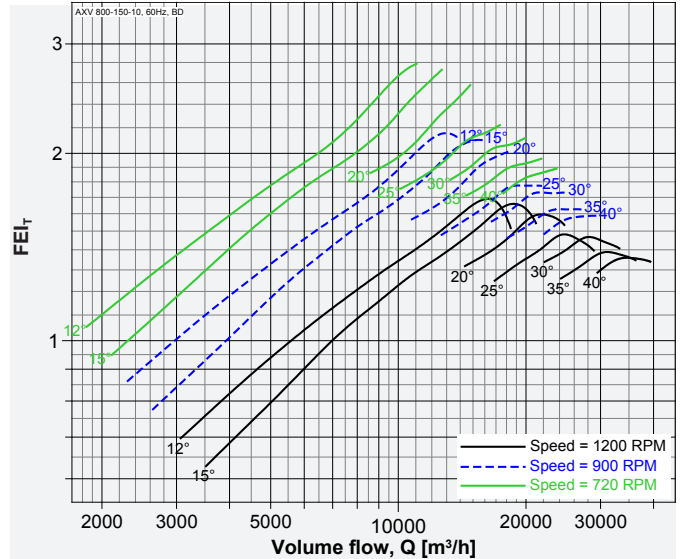

Performance of size 250 to 1250 certified is for installation type D - Ducted inlet, Ducted outlet, Performance of size 1400 to 2800 certified is for installation type A - Free inlet, Free outlet. Power rating (kW) does not include transmission losses. Performance ratings do not include the effects of appurtenances (accessories-belt cover, pulley & belt). FEI<sub>r</sub> / FEI<sub>s</sub> values are calculated in accordance with ANSI/AMCA Standard 208 and are based on default motor efficiencies (Belt Driven type). FEI<sub>r</sub> / FEI<sub>s</sub> values for fans with specific motors will vary slightly from those shown.



# Fan Energy Index

Belt Driven, 60Hz



Model: AXV 800-250-7

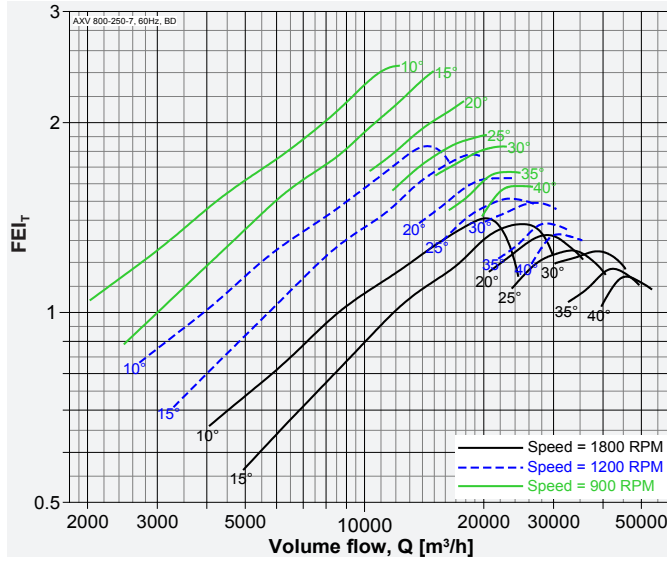

Model: AXV 800-250-9

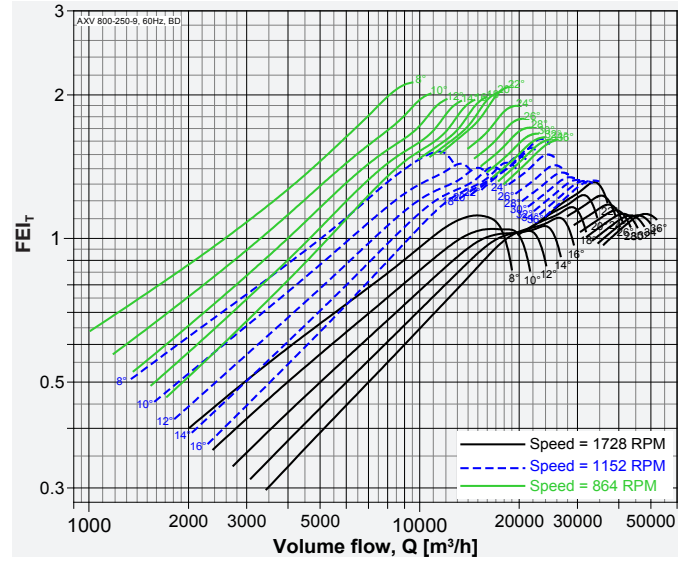

Model: AXV 800-250-14

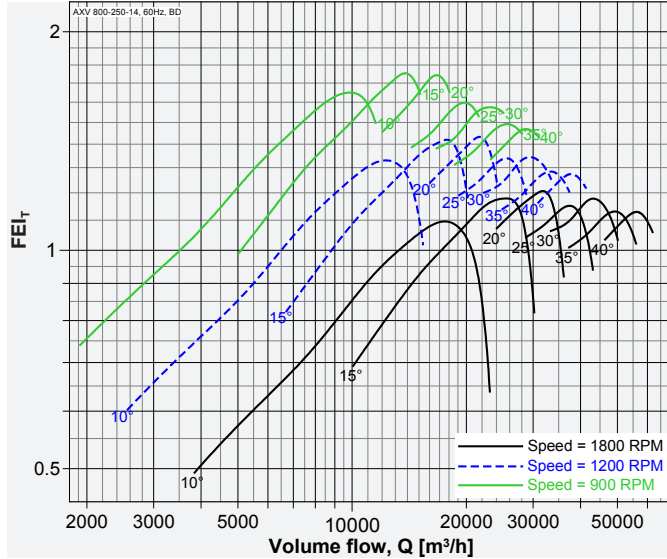

Model: AXV 900-250-7

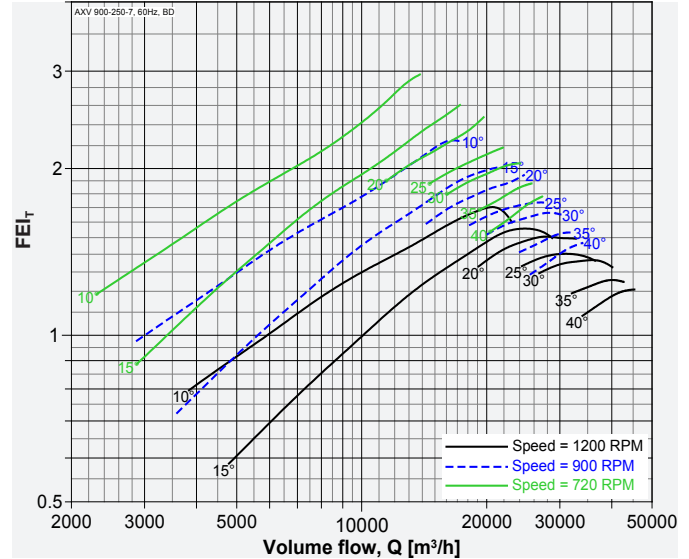

Model: AXV 900-250-14

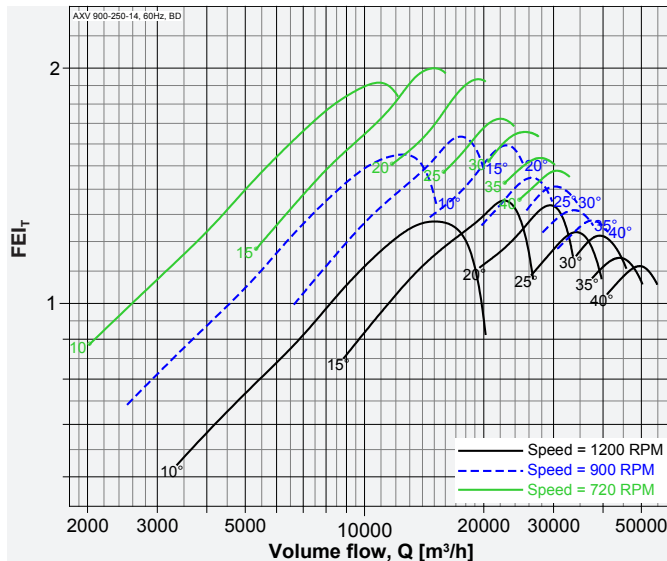

Model: AXV 900-300-10

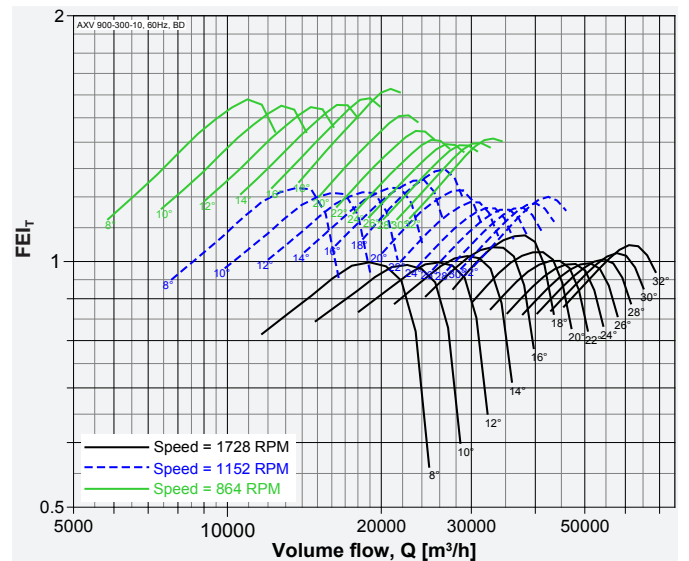

Performance of size 250 to 1250 certified is for installation type D - Ducted inlet, Ducted outlet, Performance of size 1400 to 2800 certified is for installation type A - Free inlet, Free outlet. Power rating (kW) does not include transmission losses. Performance ratings do not include the effects of appurtenances (accessories-belt cover, pulley & belt). FE<sub>1</sub> / FE<sub>2</sub> values are calculated in accordance with ANSI/AMCA Standard 208 and are based on default motor efficiencies (Belt Driven type). FE<sub>1</sub> / FE<sub>2</sub> values for fans with specific motors will vary slightly from those shown.



Model: AXV 1000-250-7

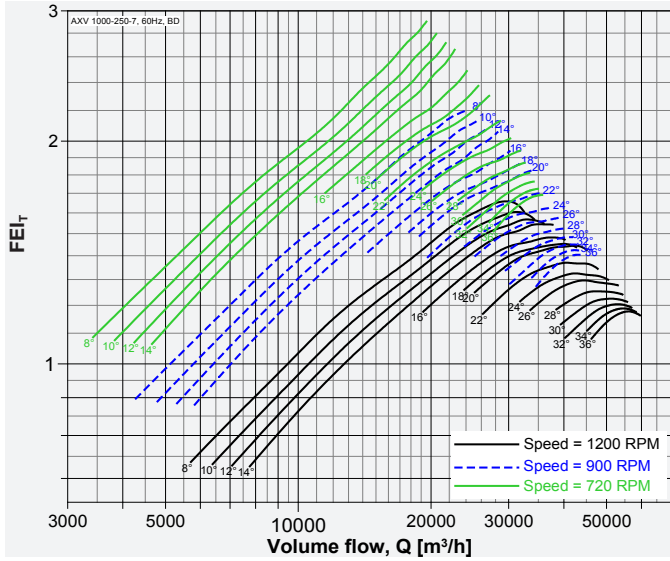

Model: AXV 1000-250-14

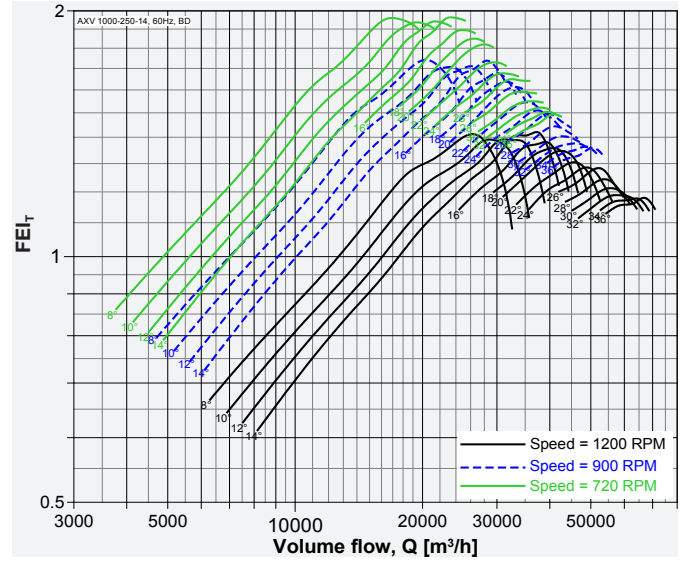

Model: AXV 1000-300-10

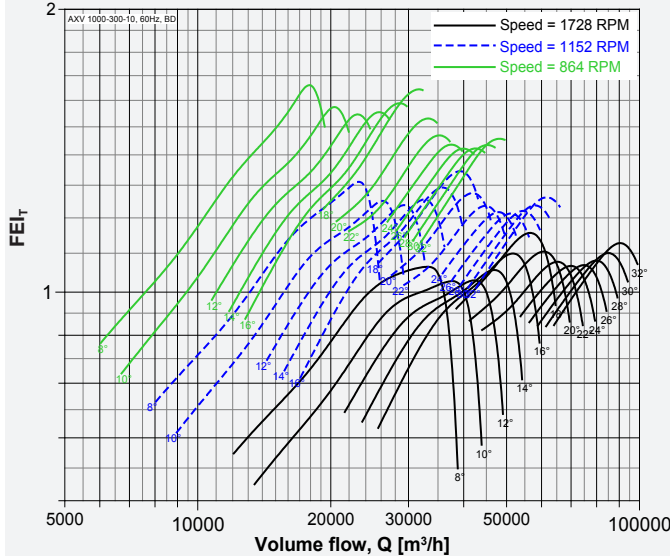

Model: AXV 1120-300-5

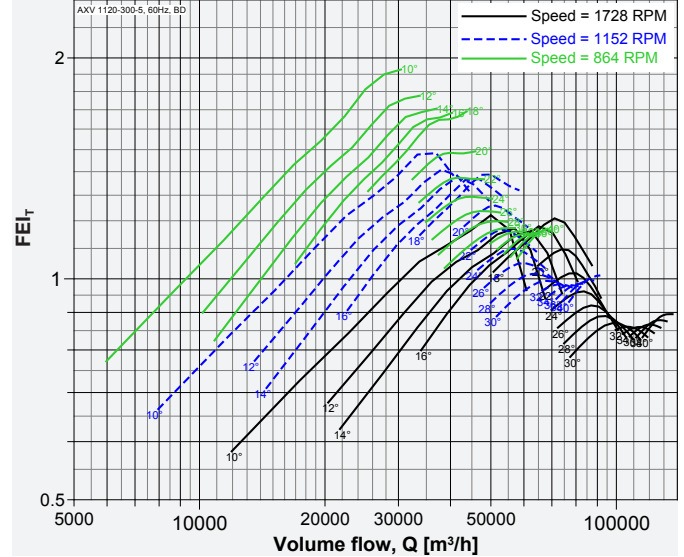

Model: AXV 1250-370-6

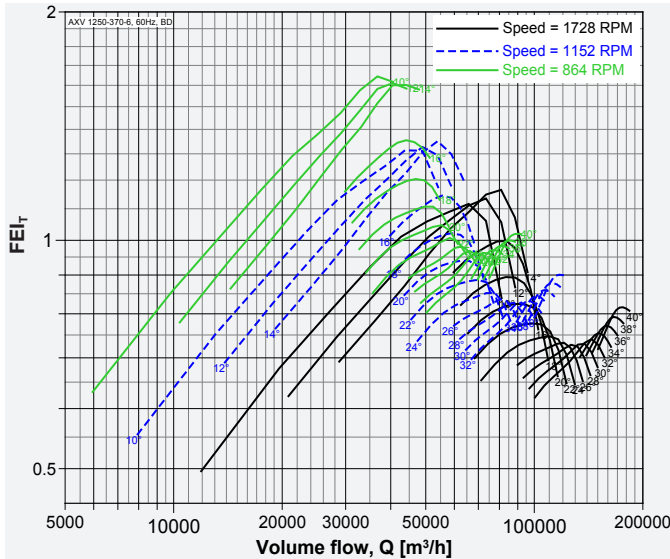

Model: AXV 1400-420-6

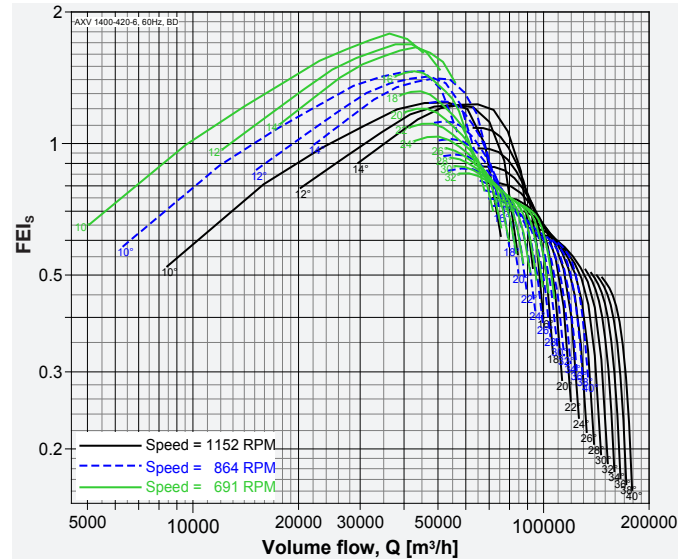

Performance of size 250 to 1250 certified is for installation type D - Ducted inlet, Ducted outlet, Performance of size 1400 to 2800 certified is for installation type A - Free inlet, Free outlet. Power rating (kW) does not include transmission losses. Performance ratings do not include the effects of appurtenances (accessories-belt cover, pulley & belt). FEI<sub>r</sub> / FEI<sub>s</sub> values are calculated in accordance with ANSI/AMCA Standard 208 and are based on default motor efficiencies (Belt Driven type). FEI<sub>r</sub> / FEI<sub>s</sub> values for fans with specific motors will vary slightly from those shown.



Model: AXV 1600-420-6

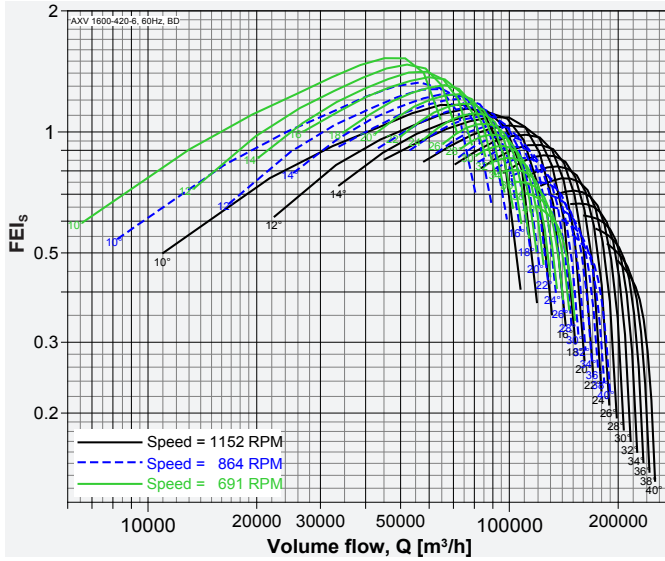

Model: AXV 1800-540-6

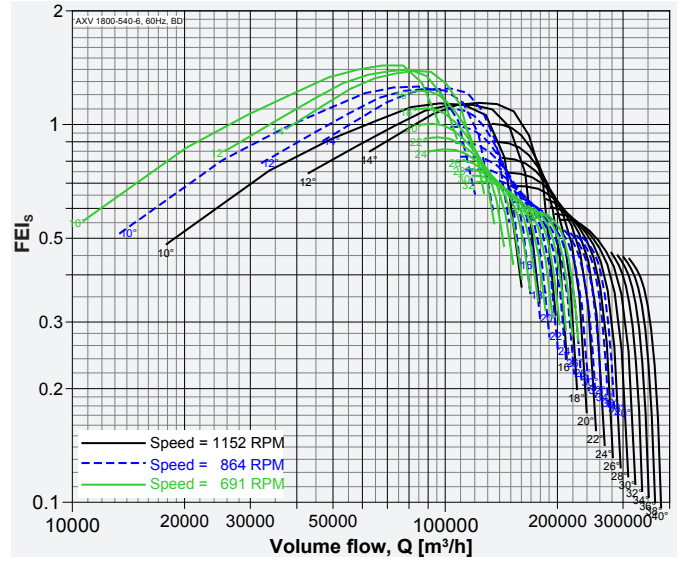

Model: AXV 2000-600-6

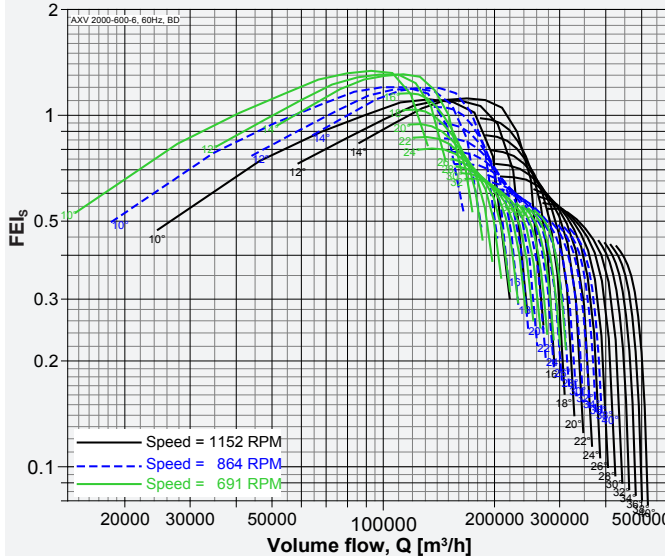

Model: AXV 2200-660-6

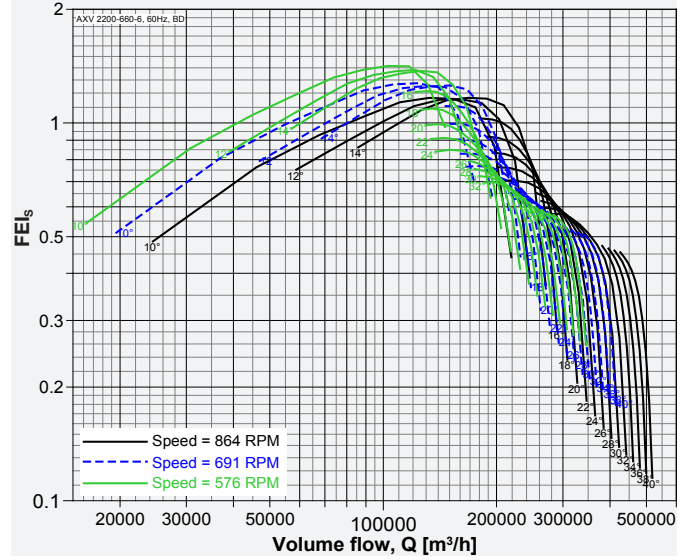

Model: AXV 2400-720-6

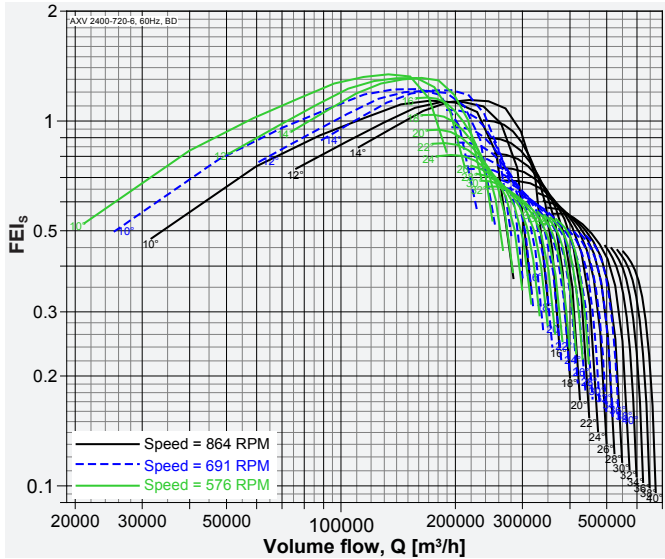

Model: AXV 2500-750-6

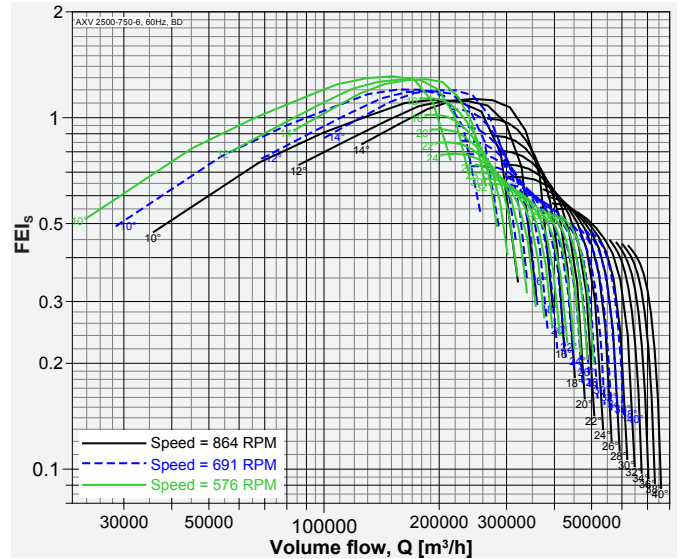

Performance of size 250 to 1250 certified is for installation type D - Ducted inlet, Ducted outlet, Performance of size 1400 to 2800 certified is for installation type A - Free inlet, Free outlet. Power rating (kW) does not include transmission losses. Performance ratings do not include the effects of appurtenances (accessories-belt cover, pulley & belt). FEI<sub>i</sub> / FEI<sub>s</sub> values are calculated in accordance with ANSI/AMCA Standard 208 and are based on default motor efficiencies (Belt Driven type). FEI<sub>i</sub> / FEI<sub>s</sub> values for fans with specific motors will vary slightly from those shown.



Model: AXV 2600-780-6

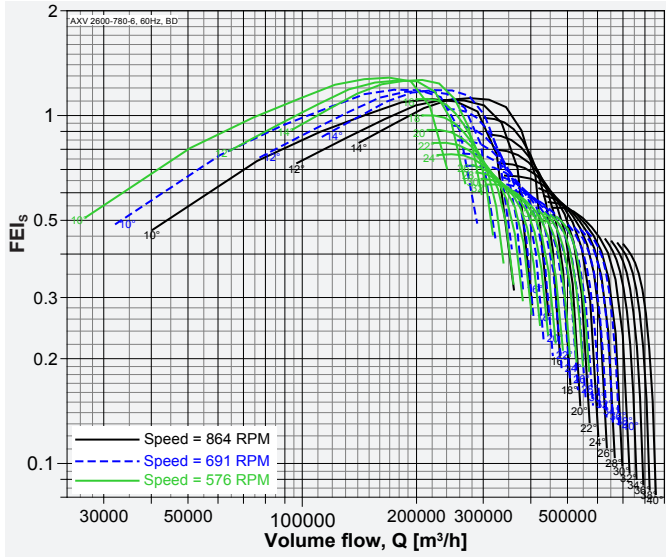

Model: AXV 2800-840-6

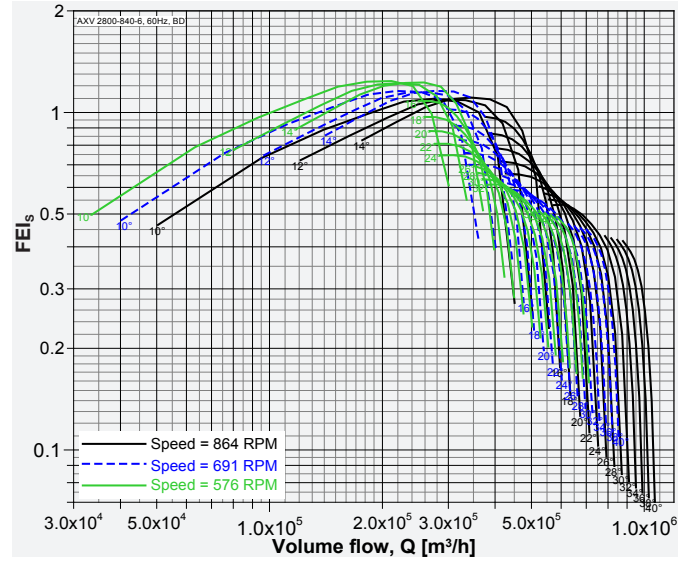

Performance of size 250 to 1250 certified is for installation type D - Ducted inlet, Ducted outlet, Performance of size 1400 to 2800 certified is for installation type A - Free inlet, Free outlet. Power rating (kW) does not include transmission losses. Performance ratings do not include the effects of appurtenances (accessories-belt cover, pulley & belt).  $FEI_7$  /  $FEI_s$  values are calculated in accordance with ANSI/AMCA Standard 208 and are based on default motor efficiencies (Belt Driven type).  $FEI_7$  /  $FEI_s$  values for fans with specific motors will vary slightly from those shown.

# Axial Flow Fans

## Dimensions



SH

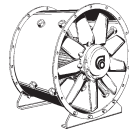

LH



### Direct Driven

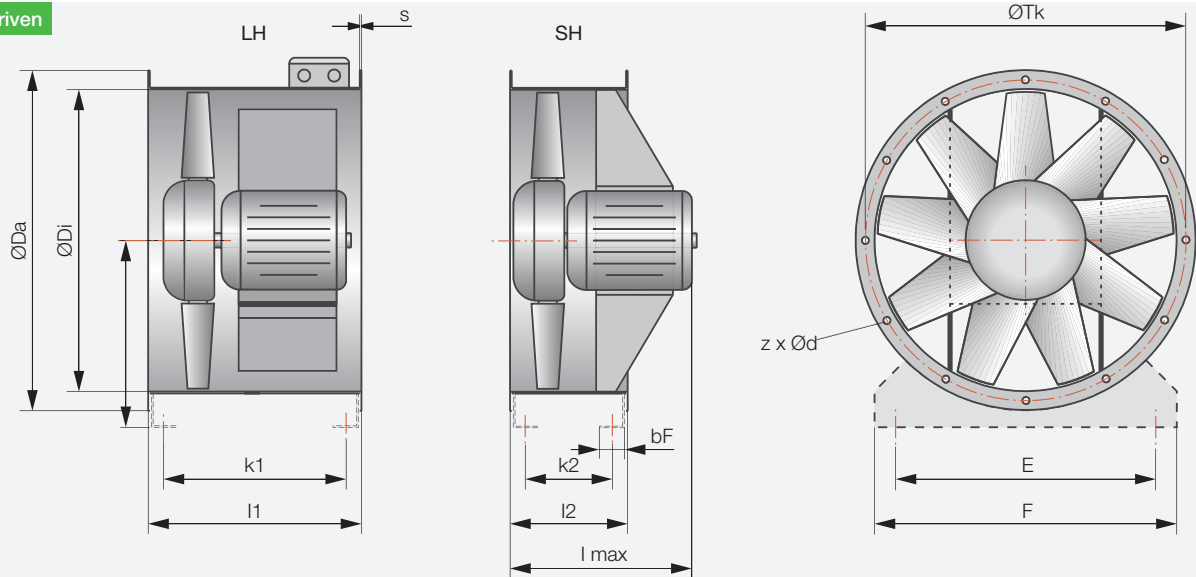

### Belt Driven

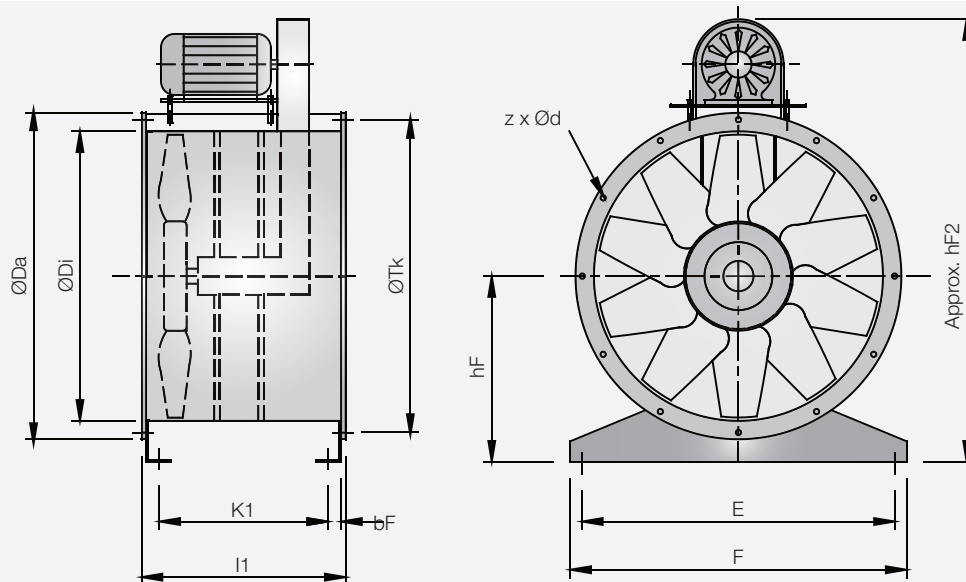

Model size	Da [mm]	Di [mm]	hF [mm]	hF2 [mm]	z x d [mm]	Tk [mm]	E [mm]	F [mm]	bF [mm]
250	306	254	165	610	8 x 12	286	210	250	60
280	336	282	185	650	8 x 12	316	240	280	60
315	388	320	205	700	8 x 12	366	265	315	60
355	428	359	225	750	8 x 12	405	305	355	60
400	472	401	250	810	12 x 12	448	350	400	60
450	522	450	280	860	12 x 12	497	400	450	60
500	574	504	315	1041	12 x 12	551	440	500	70
560	654	565	345	1094	16 x 14	629	500	560	70
630	724	634	400	1246	16 x 14	698	570	630	70
710	802	711	450	1454	16 x 14	775	650	710	70
800	889	797	500	1544	12* x 14	861	730	800	80
900	988	894	580	1746	12* x 14	958	830	900	80
1000	1095	1003	630	1821	12* x 14	1067	930	990	80
1120	1231	1125	690	1990	16* x 18	1200	1050	1110	100
1250	1370	1250	750	2175	16* x 18	1337	1180	1240	100
1400	1510	1405	830	2362	16* x 18	1475	1330	1390	100
1600	1710	1605	930	2550	20* x 18	1675	1530	1590	100

• We reserve the right to alter measurements without notice in case of technical improvements.



# Axial Flow Fans

## Dimensions



Model Size	LH/1				LH/2				SH			
	s [mm]	k1 [mm]	l1 [mm]	motor max.	s [mm]	k1 [mm]	l1 [mm]	motor max.	s [mm]	k2 [mm]	l2 [mm]	lmax [mm]
250	2	236	300	80					2	161	225	350
280	2	236	300	80					2	161	225	350
315	2	286	350	80					2	161	225	350
355	2	286	350	80					2	161	225	350
400	2	336	400	90					2	161	225	400
450	2	336	400	112					2	161	225	500
500	2	326	400	112					2	151	225	600
560	2	326	400	112	3	626	700	160	2	226	300	750
630	2	326	400	112	3	626	700	160	2	226	300	750
710	2	325	400	112	3	490	565	132	2	225	300	600
800	3	315	400	112	3	615	700	160	3	215	300	750
900	3	444	530	132	3	614	700	160	3	214	300	750
1000	3	444	530	132	3	694	780	180	3	254	340	800
1120	4	522	630	160	4	708	816	200	4	242	350	800
1250	4	522	630	160	4	708	816	225	4	242	350	800
1400					4	892	1000	225	4	242	350	800
1600					4	892	1000	280	4	242	350	800

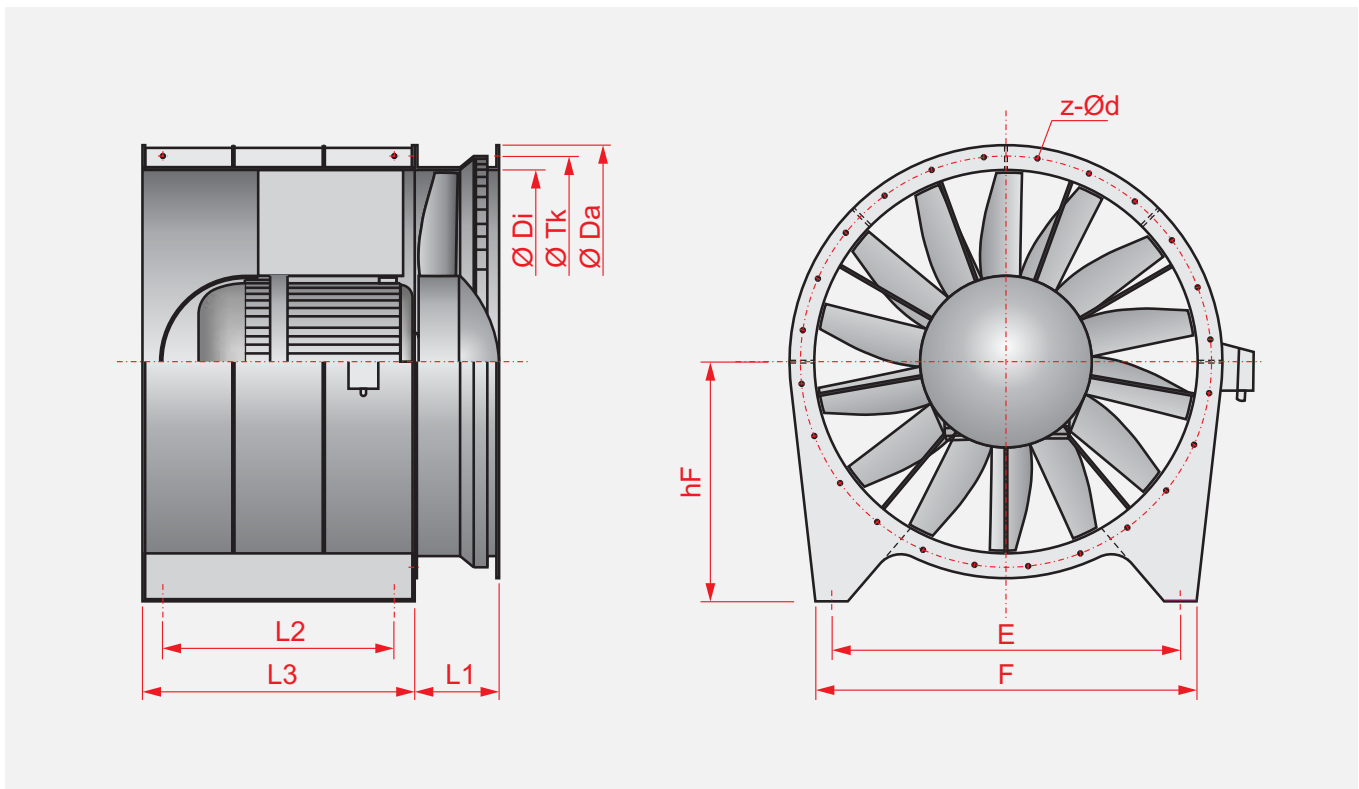

Model Size	Da [mm]	Di [mm]	hF [mm]	z x d [mm]	Tk [mm]	E [mm]	F [mm]	L1 [mm]	L2 [mm]	L3 [mm]
1800	2010	1805	1120	24x18	1920	1660	1800	400	1200	1400
2000	2210	2005	1165	32x18	2120	1820	2000	445	1300	1500
2200	2440	2205	1265	32x18	2340	2020	2200	490	1400	1650
2400	2630	2405	1370	32x18	2530	2220	2400	550	1500	1800
2500	2740	2505	1420	36x24	2640	2320	2500	555	1530	1820
2600	2840	2605	1470	36x24	2740	2380	2600	590	1580	1850
2800	3150	2805	1570	36x24	3000	2500	2800	1300	1680	1900

• We reserve the right to alter measurements without notice in case of technical improvements.

# Axial Flow Fans

## Dimensions



PM



### Square Wall Plate

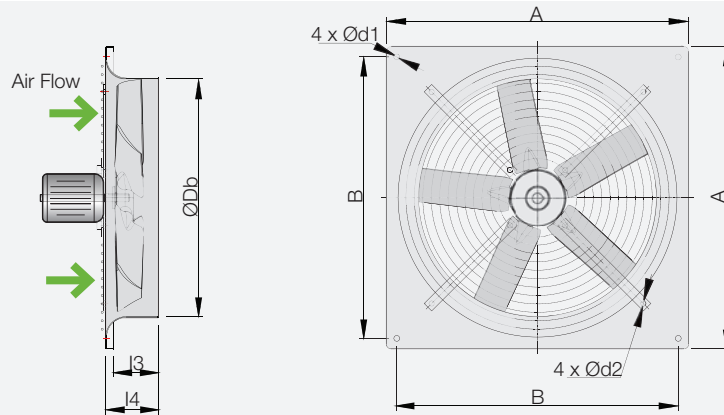

Model Size	A [mm]	B [mm]	Db [mm]	d1 [mm]	d2 [mm]	l3 [mm]	l4 [mm]
250	370	320	254	7	8,5	49	55
280	400	350	282	7	8,5	60	68
315	430	380	320	9	8,5	71	82
355	485	435	360	9	8,5	75	85
400	540	490	410	9	8,5	88	100
450	575	535	460	11	8,5	88	100
500	655	615	510	11	8,5	106	120
560	725	675	560	11	8,5	121	135
630	805	750	634	11	8,5	135	150
710	850	810	710	14,5	10,5	150	170
800	970	910	795	14,5	10,5	194	210
900	1070	1010	899	14,5	10,5	200	220
1000	1170	1110	999	14,5	10,5	200	220

### Bifurcated Axial Fan

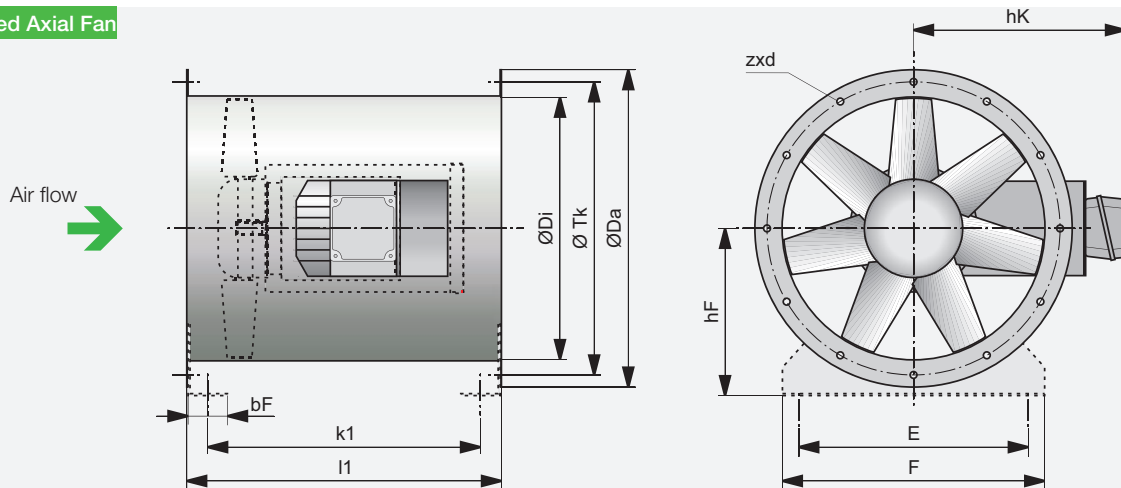

Model Size	ØDa [mm]	ØDi [mm]	ØTk [mm]	E [mm]	F [mm]	zxd	hF [mm]	bF [mm]	k1 [mm]	l1 [mm]	hK [mm]	Motor max.	Art.Nr.:
AXV-BIF 400S	484	400	448	350	400	12x12	250	60	415	480	324	90(2.2 kW)	303719
AXV-BIF 450	534	450	497	400	450	12x12	280	60	415	480	331	90(2.2 kW)	303720
AXV-BIF 560	664	560	629	500	560	16x14	345	70	624	700	410	132(7.5 kW)	303721
AXV-BIF 630	734	630	698	570	630	16x14	400	70	624	700	435	100(2.2 kW)	303722
AXV-BIF 710	814	711	775	650	710	16x14	450	70	624	700	476		303723
AXV-BIF 800	904	800	861	730	800	12*x14	500	80	614	700	504	112(4.0 kW)	303716
AXV-BIF 900	1004	894	958	830	900	12*x14	580	80	612	700	572	132(7.5 kW)	303717
AXV-BIF1000	1105	1000	1067	930	990	12*x14	630	80	692	780		160(15.0kW)	303724

• We reserve the right to alter measurements without notice in case of technical improvements. The square wall plate and Bifurcated Axial Fan are not licensed by AMCA International.

**ED**  
Bellmouth inlet

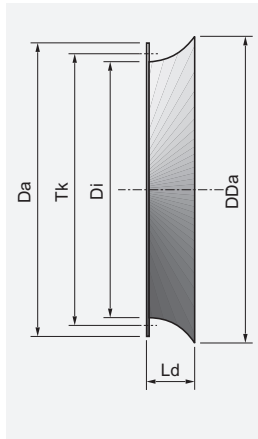

**LRK**  
Air-operated damper

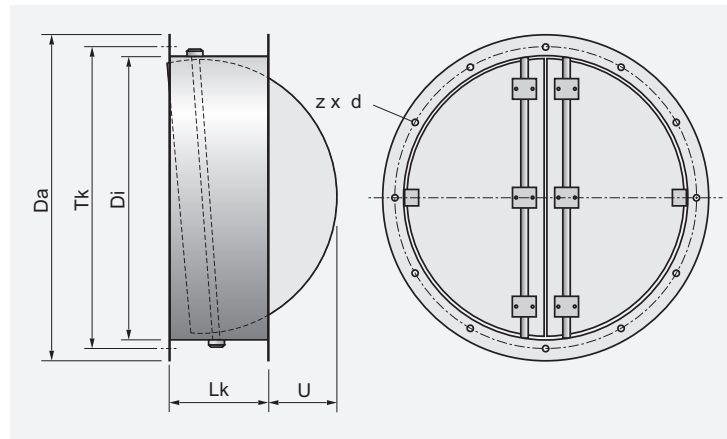

**GL-AXV**  
Matching flange

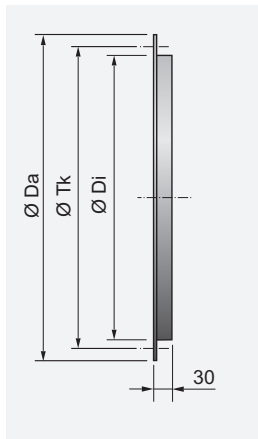

**EV-AXV**  
Flexible connector compl.

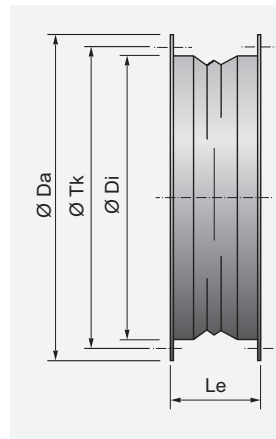

**GV-AXV**  
Up-stream guide vane

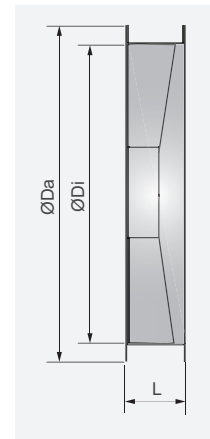

Model size	Da [mm]	Di [mm]	Tk [mm]	z x d [mm]	DDa [mm]	L [mm]	Ld [mm]	Lk [mm]	Le [mm]	U [mm]
355	438	359	405	8 x 12	435	152	165	250	130	-
400	484	401	448	12 x 12	507	152	165	250	130	-
450	534	450	497	12 x 12	555	152	165	250	130	15
500	584	504	551	12 x 12	617	152	165	250	130	45
560	664	565	629	16 x 14	667	152	165	250	130	80
630	734	634	698	16 x 14	757	152	165	250	130	120
710	814	711	775	16 x 14	816	190	170	350	130	60
800	904	797	861	12* x 14	915	190	250	350	130	110
900	1004	894	958	12* x 14	1015	200	250	350	130	170
1000	1105	1003	1067	12* x 14	1115	200	250	350	130	225
1120	1245	1125	1200	16* x 18	1243	240	250	350	130	255
1250	1370	1250	1337	16* x 18	1364	240	250	400	170	375
1400	1525	1405	1475	16* x 18	1523	260	250	400	170	450
1600	1725	1605	1675	20* x 18	1723	260	250	400	170	550

### Sound power levels

This term refers to the power which a source radiates as sound. Sound power levels are expressed in decibels with a reference level of 1 picoWatt. The sound power level of a source remains the same regardless of its environment and the distance to the listener.

If the sound power frequency spectrum is needed, for as follows: example, the design of sound attenuators, the A- rated sound power levels at particular octave band frequency  $L_{WA}$  can be calculated by subtracting the relative sound  $L_{wrel}$ .

$$L_{WA} = L_{wi} + L_{wrel}$$

### Sound pressure level

These are pressure fluctuations generated by a source expressed in decibels with a reference level of 20  $\mu$ Pa. The sound pressure level varies with the distance of a sound source to the listener and its environment.

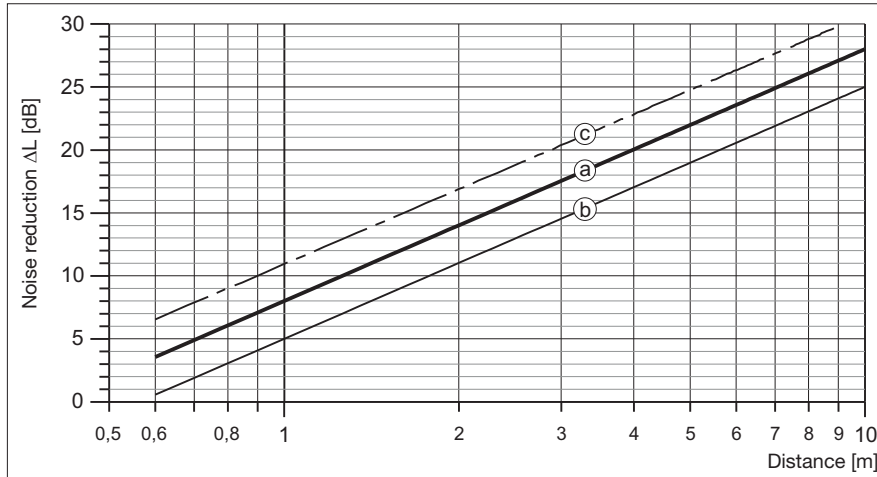

Sound level reduction half sphere

- a: without reflexion
- b: with reflexion
- c: full sphere without reflexion

### Frequencies

Sound is split into different frequencies. Frequencies of human hearing range from about 20 cycles per second (Hz) to 20.000 cycles per second (Hz). For practical purposes, WOLTER publishes noise data in eight octave bands with the centre frequencies of (63,) 125, 250, 500, 1000, 2000, 4000 and 8000 Hz.

Each fan has its own specific correction factor which is to be deducted from sound power according to the octave band and is shown on the bottom line of each performance curve.

### A-weighted sound pressure level in dB (A)

The human ear is more sensitive to sound in some frequencies than in others. The A-weighting is an attempt to reflect this natural perception of sound. The A-weighting is a set of figures which are applied to the sound pressure levels. The levels in each of the octave bands are added logarithmically to give a single figure. The A-weighting over the octave band is as follows:

Frequency [Hz]	63	125	250	500	1000	2000	4000	8000
A-weighting [dB]	-26,2	-16,1	-8,6	-3,2	0	+1,2	+1,0	-1,1

Table 2)  
Addition of sound levels

Difference between two sound levels [dB]	Add to the higher level [dB]
0 - 1	3
2 - 3	2
4 - 9	1
$\geq 10$	0

$$L_{\Sigma} = 10 \cdot \lg(10^{0,1 \cdot L_1} + 10^{0,1 \cdot L_2} + \dots + 10^{0,1 \cdot L_n})$$

where:

$L_1$  = sound level of a source 1

$L_{\Sigma}$  = resulting summation sound level

### Summation of several congeneric sound levels

$$L_{\Sigma} = L_1 + 10 \cdot \lg(z)$$

where:

$z$  = number of sources

$L_1$  = sound level of a single source

$L_{\Sigma}$  = resulting summation sound level

Relative Sound Power Frequency Spectrum ( $L_{wrel}$ ) [dB]

Fan Model	Poles	63	125	250	500	1000	2000	4000	8000
Size	[-]	[Hz]	[Hz]	[Hz]	[Hz]	[Hz]	[Hz]	[Hz]	[Hz]
250-110-3	2	-5	-6	-12	-13	-19	-25	-30	-36
	4	-2	-8	-9	-16	-21	-26	-33	-39
	6	-1	-9	-12	-19	-24	-29	-36	-41
250-110-6	2	-3	-15	-8	-11	-16	-22	-27	-33
	4	-10	-3	-6	-12	-17	-22	-29	-36
	6	-6	-2	-9	-15	-20	-26	-33	-38
280-110-3	2	-1	-7	-15	-21	-25	-30	-35	-40
	4	-1	-9	-15	-19	-24	-29	-34	-38
	6	-1	-13	-17	-21	-27	-31	-36	-40
280-110-6	2	-1	-21	-12	-22	-25	-29	-33	-38
	4	-11	-1	-11	-14	-18	-22	-27	-32
	6	-6	-2	-14	-16	-21	-25	-30	-35
315-110-3	2	-11	-4	-5	-12	-13	-20	-24	-29
	4	-4	-5	-11	-13	-19	-23	-29	-34
	6	-2	-8	-11	-15	-21	-25	-31	-35
315-110-6	2	-13	-12	-2	-9	-13	-18	-22	-28
	4	-12	-2	-9	-13	-18	-22	-27	-33
	6	-6	-2	-12	-16	-21	-25	-31	-35
355-110-3	2	-8	-6	-7	-14	-17	-22	-25	-30
	4	-4	-4	-11	-15	-20	-23	-28	-34
	6	-2	-7	-12	-17	-21	-25	-31	-34
355-110-6	2	-12	-13	-3	-11	-14	-19	-23	-29
	4	-12	-2	-10	-13	-18	-22	-28	-34
	6	-6	-2	-13	-16	-21	-26	-32	-36
355-150-7	2	-14	-10	-2	-10	-19	-26	-28	-33
	4	-10	-1	-10	-18	-26	-28	-33	-37
	6	-2	-5	-14	-22	-26	-30	-35	-39
400-110-3	2	-17	-1	-12	-20	-21	-25	-29	-33
	4	-1	-12	-20	-21	-25	-29	-33	-38
	6	0	-18	-20	-23	-27	-31	-36	-39
400-110-6	2	-12	-13	-3	-12	-13	-17	-21	-25
	4	-12	-2	-11	-13	-16	-20	-24	-29
	6	-6	-3	-13	-14	-19	-23	-27	-31
400-150-5	2	-8	-10	-5	-12	-12	-17	-21	-23
	4	-9	-3	-11	-10	-16	-19	-22	-24
	6	-3	-7	-11	-13	-18	-20	-23	-25
400-150-7	2	-11	-8	-2	-12	-15	-17	-21	-26
	4	-8	-2	-12	-14	-17	-21	-25	-34
	6	-2	-7	-13	-15	-19	-23	-30	-39
400-150-10	2	-7	-9	-10	-6	-9	-12	-17	-21
	4	-8	-9	-5	-8	-11	-15	-19	-24
	6	-9	-4	-6	-10	-13	-17	-22	-27
450-110-3	2	-10	-2	-15	-19	-19	-24	-27	-32
	4	-1	-14	-18	-18	-22	-26	-31	-35
	6	0	-18	-18	-20	-24	-28	-33	-37

• Sound power frequency spectrum calculated with this  $L_{wrel}$  are not licensed by AMCA.

Relative Sound Power Frequency Spectrum ( $L_{wref}$ ) [dB]

Fan Model	Poles	63	125	250	500	1000	2000	4000	8000
Size	[-]	[Hz]	[Hz]	[Hz]	[Hz]	[Hz]	[Hz]	[Hz]	[Hz]
450-110-6	2	-17	-18	-2	-13	-15	18	-22	-25
	4	-18	-1	-12	-15	-18	-22	-25	-28
	6	-7	-2	-16	-17	-21	-24	-27	-31
450-150-5	2	-12	-12	-3	-11	-10	-14	-18	-20
	4	-11	-3	-11	-10	-14	-17	-20	-23
	6	-3	-7	-11	-11	-16	-19	-21	-24
450-150-7	2	-8	-5	-5	-13	-18	-22	-24	-26
	4	-4	-4	-12	-17	-21	-24	-26	-27
	6	-2	-7	-14	-18	-22	-23	-25	-27
450-150-10	2	-8	-11	-10	-7	-9	-12	-16	-19
	4	-10	-9	-6	-7	-11	-15	-18	-23
	6	-9	-5	-6	-9	-13	-16	-21	-26
500-110-3	2	-7	-4	-7	-11	-12	-15	-18	-22
	4	-3	-6	-10	-11	-14	-17	-21	-25
	6	-3	-8	-10	-11	-15	-18	-23	-27
500-110-6	2	-8	-6	-6	-9	-11	-13	-17	-21
	4	-5	-5	-8	-10	-12	-16	-20	-25
	6	-4	-5	-10	-11	-14	-17	-22	-27
500-150-5	2	-9	-9	-4	-8	-12	-15	-19	-23
	4	-8	-3	-8	-12	-15	-19	-22	-26
	6	-3	-5	-11	-13	-18	-21	-25	-29
500-150-7	2	-8	-5	-6	-10	-15	-18	-21	-26
	4	-4	-5	-9	-14	-17	-21	-25	-26
	6	-3	-6	-11	-14	-18	-22	-25	-24
500-150-10	2	-7	-8	-11	-7	-7	-12	-16	-20
	4	-7	-10	-6	-6	-11	-15	-19	-25
	6	-8	-5	-5	-9	-13	-17	-22	-27
500-250-7	2	-9	-7	-4	-9	-11	-14	-17	-20
	4	-7	-4	-8	-11	-13	-17	-20	-23
	6	-5	-5	-10	-11	-15	-18	-21	-24
560-110-3	2	-4	-4	-10	-13	-18	-20	-22	-25
	4	-2	-8	-11	-15	-18	-20	-23	-28
	6	-1	-9	-13	-17	-18	-21	-25	-31
560-110-6	2	-5	-5	-9	-14	-15	-17	-19	-22
	4	-3	-7	-12	-13	-15	-17	-21	-26
	6	-4	-5	-11	-12	-15	-17	-22	-28
560-150-5	2	-5	-5	-7	-13	-15	-17	-19	-23
	4	-4	-5	-12	-13	-15	-17	-21	-27
	6	-2	-8	-11	-12	-14	-18	-23	-29
560-150-10	2	-5	-6	-11	-10	-13	-14	-16	-20
	4	-4	-9	-8	-11	-12	-14	-18	-25
	6	-6	-6	-8	-10	-11	-14	-20	-27
560-200-9	2	-11	-8	-4	-7	-15	-18	-22	-26
	4	-7	-4	-6	-14	-18	-21	-26	-31
	6	-4	-4	-11	-16	-19	-23	-28	-33

• Sound power frequency spectrum calculated with this  $L_{wref}$  are not licensed by AMCA.

Relative Sound Power Frequency Spectrum ( $L_{wrel}$ ) [dB]

Fan Model	Poles	63	125	250	500	1000	2000	4000	8000
Size	[-]	[Hz]	[Hz]	[Hz]	[Hz]	[Hz]	[Hz]	[Hz]	[Hz]
560-250-7	2	-6	-6	-6	-11	-16	-17	-20	-24
	4	-5	-5	-10	-14	-16	-18	-22	-25
	6	-4	-4	-12	-14	-16	-19	-23	-25
560-250-14	2	-4	-5	-10	-13	-13	-15	-18	-21
	4	-3	-8	-11	-11	-13	-15	-19	-22
	6	-4	-8	-8	-9	-12	-15	-18	-21
630-110-3	4	-5	-5	-11	-15	-15	-19	-23	-26
	6	-2	-7	-13	-14	-16	-20	-24	-27
	8	-1	-10	-14	-14	-17	-22	-25	-28
630-110-6	4	-7	-3	-13	-14	-13	-17	-21	-25
	6	-4	-4	-15	-13	-16	-20	-23	-27
	8	-2	-11	-12	-12	-16	-19	-23	-27
630-150-5	4	-6	-3	-16	-17	-17	-20	-24	-28
	6	-1	-10	-17	-16	-18	-22	-25	-30
	8	-1	-14	-15	-15	-18	-22	-26	-30
630-150-10	4	-3	-9	-9	-13	-12	-16	-20	-26
	6	-5	-6	-9	-10	-12	-16	-21	-27
	8	-6	-5	-10	-9	-13	-17	-22	-28
630-200-9	2	-9	-6	-8	-5	-13	-15	-19	-22
	4	-6	-8	-4	-12	-15	-18	-22	-27
	6	-7	-4	-7	-13	-15	-19	-23	-29
630-250-7	4	-5	-5	-10	-13	-12	-15	-18	-21
	6	-4	-4	-12	-12	-13	-17	-19	-22
	8	-3	-7	-11	-11	-14	-17	-19	-22
630-250-14	4	-7	-7	-6	-10	-11	-13	-16	-20
	6	-7	-6	-6	-10	-11	-15	-18	-22
	8	-6	-5	-9	-9	-12	-15	-19	-23
710-110-3	4	-4	-5	-11	-13	-14	-17	-20	-23
	6	-2	-8	-12	-13	-15	-18	-21	-24
	8	-2	-10	-12	-12	-15	-19	-22	-25
710-110-6	4	-7	-5	-7	-13	-13	-16	-21	-24
	6	-5	-5	-12	-12	-14	-18	-22	-25
	8	-4	-6	-12	-12	-15	-19	-23	-26
710-150-5	4	-6	-4	-10	-13	-14	-17	-21	-25
	6	-3	-7	-12	-13	-15	-19	-23	-26
	8	-2	-9	-12	-12	-16	-20	-24	-26
710-150-10	4	-6	-7	-6	-11	-11	-14	-18	-20
	6	-6	-5	-9	-11	-11	-15	-18	-20
	8	-6	-5	-10	-10	-13	-16	-18	-20
710-250-7	4	-5	-6	-9	-11	-11	-14	-19	-22
	6	-5	-6	-10	-10	-12	-16	-20	-22
	8	-4	-7	-9	-10	-13	-17	-20	-22
710-250-9	4	-7	-4	-8	-12	-14	-18	-22	-28
	6	-4	-5	-11	-12	-16	-20	-25	-31
	8	-3	-7	-11	-13	-17	-21	-27	-33

• Sound power frequency spectrum calculated with this  $L_{wrel}$  are not licensed by AMCA.

Relative Sound Power Frequency Spectrum ( $L_{wref}$ ) [dB]

Fan Model	Poles	63	125	250	500	1000	2000	4000	8000
Size	[-]	[Hz]	[Hz]	[Hz]	[Hz]	[Hz]	[Hz]	[Hz]	[Hz]
710-250-14	4	-6	-9	-7	-8	-10	-12	-16	-19
	6	-6	-9	-7	-8	-10	-14	-17	-19
	8	-8	-6	-7	-8	-11	-14	-17	-20
800-150-5	4	-8	-5	-8	-13	-14	-18	-23	-27
	6	-4	-6	-10	-13	-15	-21	-25	-28
	8	-4	-7	-12	-13	-17	-22	-25	-29
800-150-10	4	-8	-11	-3	-13	-12	-16	-21	-24
	6	-11	-2	-8	-13	-13	-19	-22	-25
	8	-10	-2	-12	-11	-15	-20	-23	-26
800-250-7	4	-6	-6	-8	-10	-11	-14	-19	-22
	6	-5	-6	-8	-10	-11	-16	-20	-22
	8	-5	-6	-8	-9	-13	-18	-20	-23
800-250-9	4	-6	-6	-6	-11	-13	-17	-20	-26
	6	-5	-5	-9	-11	-15	-18	-23	-30
	8	-4	-5	-10	-12	-16	-19	-25	-32
800-250-14	4	-8	-9	-5	-9	-10	-13	-17	-20
	6	-9	-7	-5	-10	-11	-15	-19	-22
	8	-8	-4	-8	-9	-12	-17	-20	-23
900-250-7	4	-5	-9	-10	-12	-11	-13	-15	-18
	6	-6	-7	-10	-10	-10	-12	-14	-17
	8	-6	-7	-10	-9	-10	-12	-15	-18
900-250-14	4	-12	-11	-7	-9	-9	-9	-12	-16
	6	-12	-9	-7	-10	-9	-11	-14	-18
	8	-10	-7	-8	-9	-9	-12	-15	-20
900-300-10	4	-7	-7	-6	-10	-11	-14	-18	-25
	6	-7	-5	-8	-10	-12	-16	-21	-29
	8	-6	-5	-9	-10	-13	-17	-24	-32
1000-250-7	4	-12	-10	-9	-7	-7	-10	-14	-18
	6	-11	-9	-7	-7	-8	-12	-16	-20
	8	-10	-8	-7	-7	-9	-13	-17	-21
1000-250-14	4	-12	-11	-8	-8	-7	-9	-12	-15
	6	-12	-9	-8	-7	-8	-10	-14	-17
	8	-10	-8	-8	-7	-8	-12	-15	-18
1000-300-10	4	-7	-5	-7	-12	-12	-13	-17	-22
	6	-5	-5	-10	-11	-12	-15	-19	-26
	8	-4	-6	-11	-10	-12	-16	-21	-30
1120-300-5	4	-7	-6	-9	-9	-12	-15	-19	-24
	6	-4	-7	-8	-10	-14	-17	-21	-28
	8	-4	-7	-8	-11	-14	-17	-22	-31
1250-370-6	4	-7	-5	-9	-11	-12	-14	-18	-23
	6	-5	-6	-10	-10	-12	-16	-19	-27
	8	-4	-8	-10	-10	-13	-17	-22	-31
1400-420-6	6	-9	-8	-10	-9	-10	-12	-15	-20
	8	-7	-9	-9	-9	-10	-13	-16	-23
	10	-7	-9	-9	-9	-10	-13	-18	-25

• Sound power frequency spectrum calculated with this  $L_{wref}$  are not licensed by AMCA.



Relative Sound Power Frequency Spectrum ( $L_{wrel}$ ) [dB]

Fan Model	Poles	63	125	250	500	1000	2000	4000	8000
Size	[-]	[Hz]	[Hz]	[Hz]	[Hz]	[Hz]	[Hz]	[Hz]	[Hz]
1600-420-6	6	-9	-7	-8	-9	-11	-15	-19	-24
	8	-7	-7	-8	-9	-12	-17	-21	-25
	10	-7	-7	-8	-9	-13	-18	-22	-26
1800-540-6	6	-9	-7	-10	-10	-10	-12	-16	-21
	8	-7	-8	-9	-9	-10	-13	-17	-23
	10	-7	-9	-9	-9	-10	-13	-18	-25
2000-600-6	6	-8	-7	-10	-10	-11	-13	-16	-21
	8	-6	-8	-10	-9	-10	-13	-17	-24
	10	-7	-9	-9	-9	-10	-14	-18	-25
2200-660-6	8	-6	-8	-10	-10	-10	-13	-17	-24
	10	-6	-9	-9	-9	-11	-14	-18	-26
	12	-7	-9	-9	-9	-11	-15	-20	-27
2400-720-6	8	-6	-8	-10	-10	-11	-13	-17	-24
	10	-6	-9	-9	-9	-11	-14	-19	-26
	12	-7	-9	-9	-9	-11	-15	-20	-27
2500-750-6	8	-6	-8	-10	-10	-11	-14	-17	-24
	10	-6	-9	-9	-9	-11	-14	-19	-26
	12	-7	-9	-9	-9	-11	-15	-20	-27
2600-780-6	8	-6	-8	-10	-10	-11	-14	-17	-24
	10	-6	-9	-9	-9	-11	-14	-19	-26
	12	-6	-9	-9	-9	-11	-15	-20	-27
2800-840-6	8	-5	-9	-10	-10	-11	-14	-17	-24
	10	-6	-9	-9	-9	-11	-14	-19	-26
	12	-6	-9	-9	-9	-11	-15	-20	-28

• Sound power frequency spectrum calculated with this  $L_{wrel}$  are not licensed by AMCA.

# Tubular Sound Attenuator

SA, SPA



## SPA 450 -1D

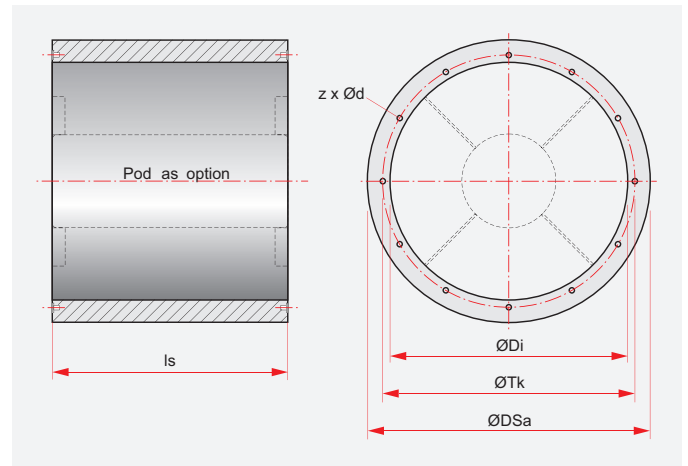
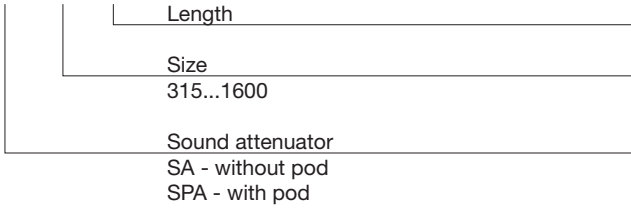

Attenuators made of galvanised sheet steel. Connecting flanges correspond to those of the AXV axial fan series.

Size	DSa	Tk	Di	ls		■				Length	Type	Pitch angle	Octave band mid-frequency [Hz]							
				x 1D	x 2D	SA-1D	SPA-1D	SA-2D	SPA-2D				setting	63	125	250	500	1k	2k	4k
	[mm]	[mm]	[mm]	[mm]	[mm]	[kg]	[kg]	[kg]	[kg]											
315	420	366	320	315	630	9,5	15	13	19	1D	SA-1D	all	2	4	6	10	14	10	7	8
355	459	405	359	355	710	12	18	16	23		SPA-1D	low	4	6	8	13	20	21	18	16
400	601	448	401	400	800	14	23	19	29			med	4	6	8	12	18	19	18	14
450	650	497	450	450	900	18	29	23	36			high	4	6	8	11	13	16	16	11
										2D	SA-2D	low	4	7	12	18	22	17	12	13
												med	4	7	11	17	21	17	13	12
												high	4	7	10	15	19	16	13	10
											SPA-2D	low	7	10	15	24	32	35	30	28
												med	7	10	15	21	26	26	24	22
												high	7	10	15	16	15	17	13	13
500	704	551	504	500	1000	22	36	28	43	1D	SA-1D	all	3	4	8	14	14	9	8	7
560	765	629	565	560	1120	25	41	31	50		SPA-1D	low	4	6	9	17	26	21	18	12
630	834	698	634	630	1260	29	47	37	59			med	4	6	9	17	23	20	18	11
710	911	775	711	710	1420	37	60	47	75			high	4	6	9	16	17	16	14	11
800	997	861	797	800	1600	69	108	90	141	2D	SA-2D	low	6	8	14	23	24	15	13	10
												med	6	8	13	22	22	14	13	9
												high	6	8	12	20	18	13	11	9
											SPA-2D	low	8	11	16	30	39	35	32	22
												med	8	11	16	27	32	32	29	19
												high	8	11	16	24	23	23	24	17
900	1094	958	894	900	1800	86	135	112	176	1D	SA-1D	all	3	4	9	14	12	8	7	7
1000	1203	1067	1003	1000	2000	125	190	156	234		SPA-1D	low	4	6	11	22	21	16	14	11
1120	1325	1200	1125	1120	2240	132	210	169	260			med.	4	6	11	20	19	15	13	11
1250	1450	1337	1250	1250	2500	146	234	185	294			high	4	6	11	17	17	14	12	11
										2D	SA-2D	low	6	8	14	22	20	13	12	10
												med.	6	8	13	21	18	12	11	10
												high	6	8	12	19	15	11	10	9
											SPA-2D	low	8	11	19	30	32	30	24	17
												med.	8	11	19	26	27	26	22	17
												high	8	11	19	21	20	22	20	16
1400	1605	1475	1405	1400	2800	197	316	250	397	1D	SA-1D	all	4	5	10	14	11	7	6	6
1600	1805	1675	1605	1600	3200	275	540	348	682		SPA-1D	low	5	7	12	21	20	14	12	9
												med.	5	7	12	19	18	13	11	9
												high	5	7	12	15	16	12	10	8
										2D	SA-2D	low	8	9	15	20	19	12	11	9
												med.	8	9	14	20	17	11	10	9
												high	8	9	13	19	14	10	9	9
											SPA-2D	low	10	14	22	28	31	29	18	15
												med.	10	14	22	25	27	25	16	15
												high	10	14	22	21	21	21	15	14

• Low, Medium and High Pitch Angle setting correspond to 10°, 22° and 35° pitch angle approximately: for other pitch angles use interpolation.

• Sizes 1800 - 2800 TBA.

Pressure Loss SPA - 1D

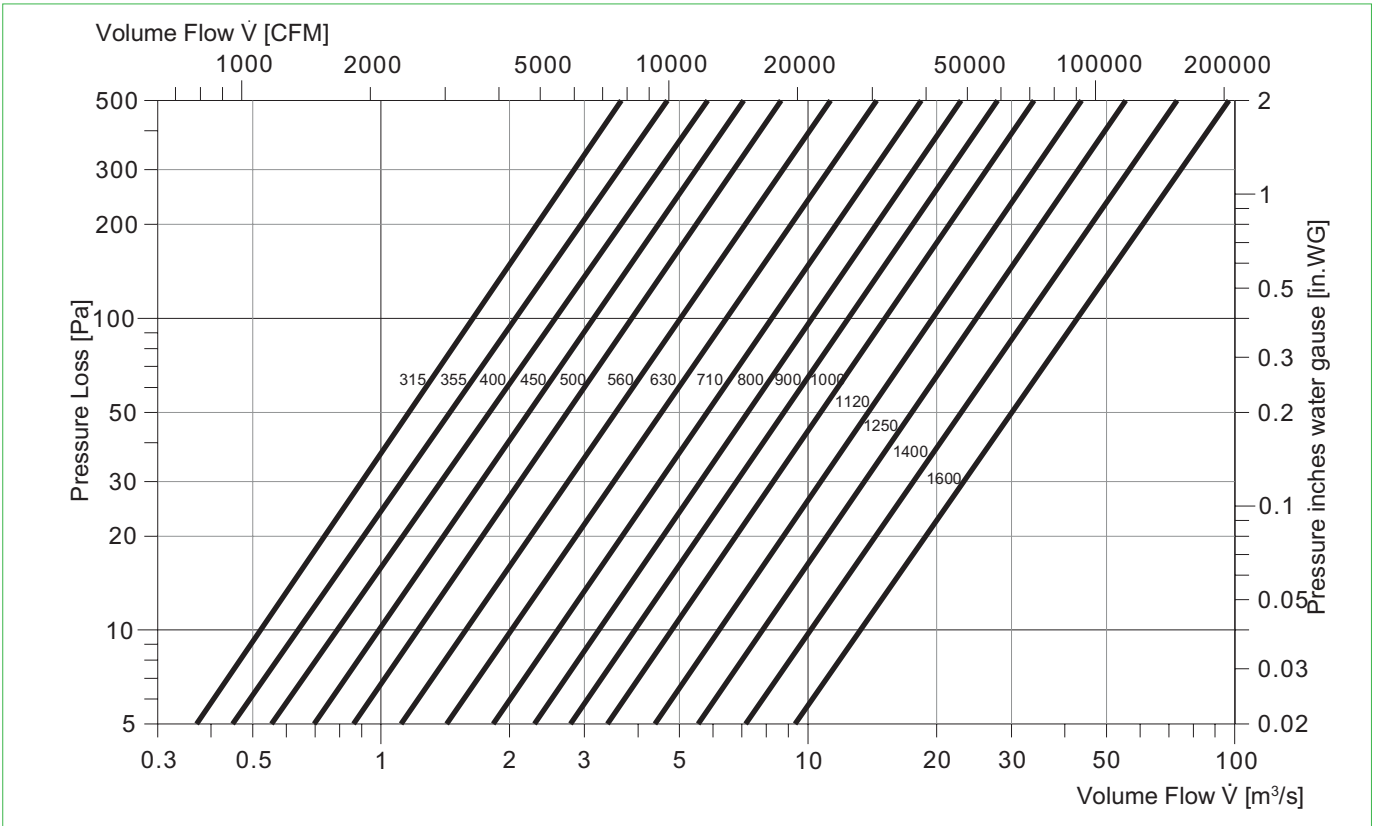

Pressure Loss SPA - 2D

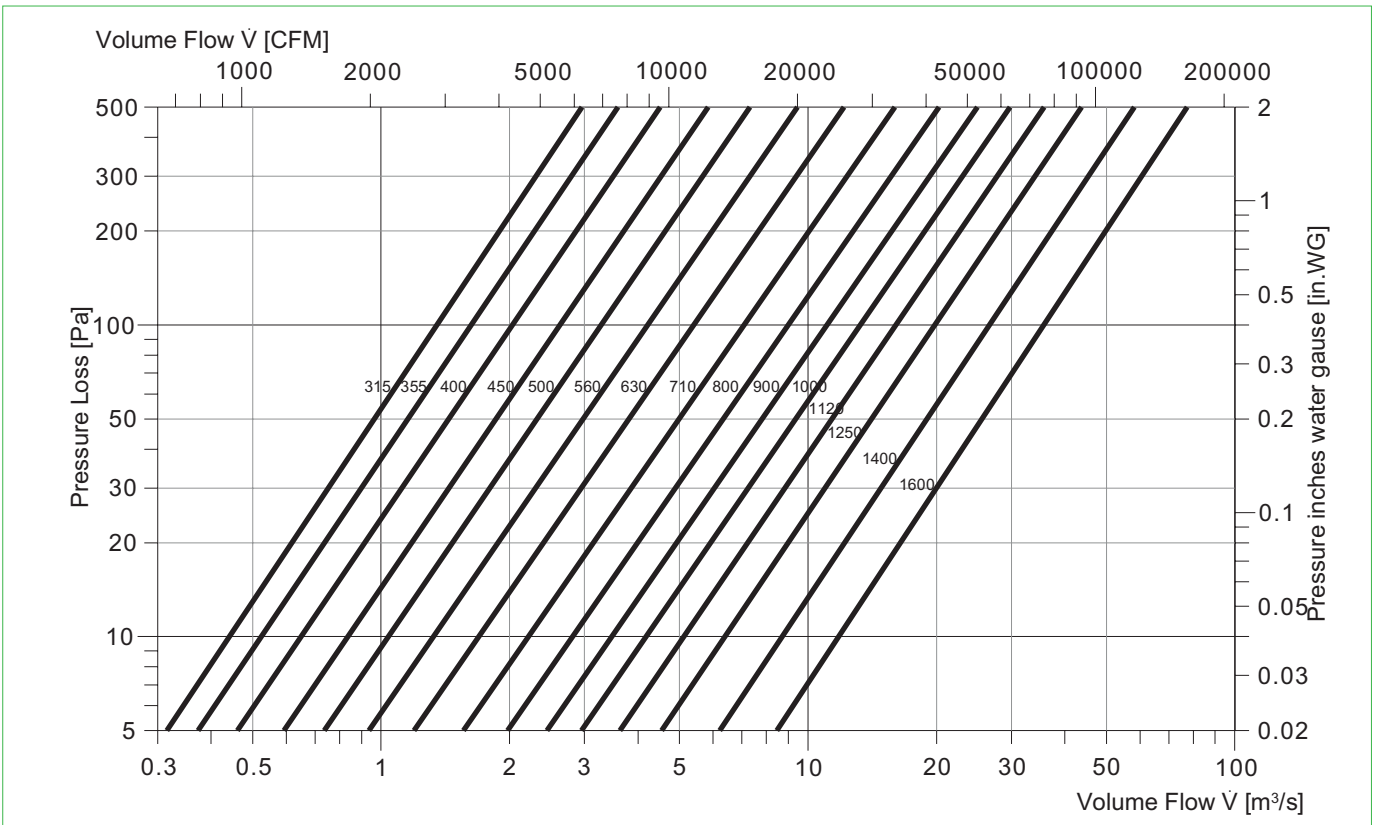

• Performance of sound attenuator are not licensed by AMCA International.

# Wolter Sales Network

## Inland

Ing. Günther Rößler  
D-07619 Schkölen  
Tel. (+49) 03 66 94 / 22 359  
Fax (+49) 03 66 94 / 22 357  
guenther.roessler@wolterfans.de

Mattias Industrievertretungen  
D-16259 Bad Freienwalde  
Tel. (+49)03344/301994  
Fax (+49)03344/301996  
thomas.mattias@wolterfans.de

Industrieservice Drexler  
D-49080 Osnabrück  
Tel. (+49) 0 541 / 20 04 88 3  
Fax (+49) 0 541 / 20 04 88 4  
wolfgang.drexler@wolterfans.de

Burkhardt Projekt GmbH  
D-67583 Guntersblum  
Tel. (+49) 0 62 49 / 82 01  
Fax (+49) 0 62 49 / 88 58  
info@bp-wolter.de

Friedrich Glock  
D-97980 Bad Mergentheim  
Tel. (+49) 0 79 31 / 37 44  
Fax (+49) 0 79 31 / 28 58  
friedrich.glock@wolterfans.de

## Europe

### Danmark:

Aircon Teknik A/S  
DK-8200 Aarhus N  
Tel. +45 (0) 86 / 34 51 11  
Fax +45 (0) 86 / 34 58 10  
post@airconteknik.dk

### The Netherlands:

AirFan B. V.  
NL-7442 CX Nijverdal  
Tel. (+31)054/8366366  
Fax (+31)054/8365320  
ventilatie@airfan.nl

### Poland:

Wentoprodukt  
44-100 Gliwice  
Tel. (+48)32 33 13 424  
Fax (+48)32 72 97 653 75  
biuro@wentoprodukt.pl

### Russia:

Daichi Co. Ltd  
RU-123022 Moscow  
Tel. +7 (0) 495 / 73 73 733  
Fax +7 (0) 495 / 73 73 732  
info@daichi.ru

### Switzerland:

Anson AG Zürich  
CH-8055 Zürich  
Tel. (+41) 0 44 / 46 11 111  
Fax (+41) 0 44 / 46 13 111  
info@anson.ch

Ventra Technik AG  
CH-8599 Salmsach  
Tel. (+41) 0 71 / 46 11 447  
Fax (+41) 0 71 / 46 11 448  
ventra@bluewin.ch

### Turkey:

Air Trade Centre Ltd Sti Türkiye,  
TR-34418 Seyrantepe / Istanbul  
Tel. (+90) 02 12 / 28 34 510  
Fax (+90) 02 12 / 27 83 964  
atc.turkey@airtradecentre.com

### United Kingdom:

Wolter (UK) Ltd.  
GB-Leicestershire LE65 1AL  
Tel. (+44) 01530 / 412 473  
info@wolteruk.com

## Middle East and North Africa

### Israel:

Pach Taas (Ashkelon) Ltd.  
IL-78100 Ashkelon  
Tel. (+972) 0 8 / 67 19 770  
Fax (+972) 0 8 / 67 19 771  
info@pachtaas.com

### UAE, Qatar, Lebanon, Jordan, Saudi Arabia:

Energy International Co.  
UAE-Sharjah, P.O. Box 3562  
Tel. (+971) 06 / 53 43 477  
Fax (+971) 06 / 53 43 756  
fsalibi@energysysh.ae

Energy International Co.  
P.O. Box 45217 Abu Dhabi, UAE  
Tel. (+971) 2 67 11 10 8  
Fax (+971) 2 67 69 669  
amohsen@energyintl.ae

Energy International Co.(Dubai-Sharjah)  
P.O. Box 3562 Sharjah, UAE  
Tel. (+971) 65 34 34 77  
Fax (+971) 65 34 37 56  
fsalibi@energysysh.ae

Energy International Corporation  
Malaz Area, Siteen Highway Beside BANK  
ALBILAD Riyadh, Saudi Arabia  
Tel. (+966) 14 15 39 59  
msheet@energyintl.com

Energy International Corporation  
P.O. Box 37364 Doha, Qatar  
Tel. (+974) 45 80 765  
Fax (+974) 45 81 126  
aassi@energyintl.com

Energy International  
234 Balbesi Blg 2nd floor Al-Madinah,  
Al Munawarah St Amman, Jordan  
Tel. (+962) 65 67 19 15  
Fax (+962) 65 67 19 16  
eabuzahra@energyintl.com

Energy International & Engineering  
Mar Roukoz Center-Block B - First Floor,  
Hazmieh, Lebanon  
Tel. (+961) 54 50 61 0  
Fax (+961) 54 51 16 9  
bsaab@energyintl.com

## Asia

### China Mainland:

Dongguan Wolter Chemco Ventilation Ltd.  
Chemco Building, Miao Bian Wang Ind.  
Shipai, Dongguan City, Guangdong  
Tel. (+86) 0 769 / 8655 7298  
Fax (+86) 0 769 / 8655 7278  
info@wolterfans.com

Taizhou Wolter Ventilation Co. Ltd.  
Hengjie, Luqiao District  
Taizhou City, Zhejiang  
Tel. (+86) 0 576 / 26 22 666 (26 52 888)  
Fax (+86) 0 576 / 26 56 830

### Hongkong:

Wolter Asia Ltd.  
Hong Kong  
Tel. (+852) 0 2456 0198  
Fax (+852) 0 2456 0290  
info@wolter.com.hk

### India:

Wolter Ventilators India Pvt. Ltd.  
867 D, Block-A, Sushant Lok, Phase-I,  
Gurgaon - 122009 (Haryana)  
Tel. +91 124 2577797, 4261001-3  
sales@wolterindia.in

### Indonesia:

PT Lung Makmur Abadi.  
Kawasan Pergudangan Taman Tekno Blok  
M/16, Serpong-Tangerang 15310  
Tel. +62 (0) 21 / 7588 2609 ext 104  
Fax +62 (0) 21 / 7588 2610  
lma.wolter@gmail.com

### Korea:

Kaceco-Wolter  
14-1, Dang-dong, Gunpo-shi, Gyeonggi-do  
Tel. +82 (0) 31 / 4773 104  
Fax +82 (0) 31 / 4773 132  
wolter@kaceco.com / info@kaceco.com

### Malaysia:

Vibrantech (M) Sdn Bhd.  
47200 Petaling Jaya Selangor, Malaysia  
Tel. +603 (0) 7847 3500  
Fax +603 (0) 7847 3380  
sales@vibrantech-sb.com

### Singapore:

Wolter Pte. Ltd.  
SG-569738 Singapore  
Tel. (+65) 0 63 / 52 95 48  
Fax (+65) 0 63 / 52 95 47  
info@wolterfans.com.sg

### Sri Lanka:

Sirocco Air Technologies (Pvt) Ltd.  
28/12, Gemunu Mawatha, Kotuwegoda,  
Rajagiriya, Sri Lanka  
Tel. +94 11 7 392 010  
Fax +94 11 7 392 015  
suren@sairt.com

### Taiwan:

Waxlink International Co., Ltd.  
8F-2 No.218 Roosevelt Rd., Sec.6  
Taipei, Taiwan  
Tel. (+886) 02 / 8932 1196  
Fax (+886) 02 / 8932 1197  
waxlink@mail.waxlinktw.com

### Thailand:

Wolter Ventilation Co., Ltd.  
Thamai Kratumban Samutsakorn 74110  
Thailand  
Tel. +66 (0) 3486 6555  
Fax +66 (0) 3486 6599  
natiphan@wolterfan.com

## Australia

### The Sydney Fan Company.

NSW 2147, Sydney, Australia  
Tel. +61 (0) 2 / 9624 4000  
Fax +61 (0) 2 / 9624 4100  
sales@thesydneyfancompany.com

## Wolter GmbH Maschinen-und Apparatebau KG

Am Wasen 11  
D-76316 Malsch / Germany  
Tel. +49 (0) 7204/9201-0  
Fax +49 (0) 7204/9201-11  
www.wolter.eu  
info@wolter.eu





# ***Air In Motion***

Reference: **A09**, V2022/February, Printed in February, 2022

**Dongguan Wolter Chemco Ventilation Ltd. (Wolter Asia)**

Shipai, Dongguan City, Guangdong Province, P.R.China

Tel. (+86)769 8655 7298, Fax (+86)769 8655 7278

[www.wolterfans.com](http://www.wolterfans.com)

[info@wolterfans.com](mailto:info@wolterfans.com)

**wolter** 