

SOLIDS-LIQUID SEPARATION

SEPCOM™ Pig

Pig Manure Treatment System



MULTIPLE PATENTS

MAKE THE MOST OF YOUR PIG MANURE

The SEPCOM™ system is a comprehensive range of equipment designed to **turn your pig manure into an even more valuable resource.**

In agriculture, untreated manure can be used as organic fertiliser only within certain limits.

To **make the most of your manure** you need to separate it into a solid and a liquid phase.

Solid Phase turns into:  **a high-quality organic soil conditioner**

- Easy to shovel, store and transport
- Odourless
- Can be sold as soil conditioner

Liquid Phase turns into:  **an enriched liquid fertiliser**

- Can be used for fertigation
- Low fresh water consumption and minimised solids content
- Easy to mix, pump, spread and store



SEPCOM™ TREATMENT SYSTEM IN A PIG FARM

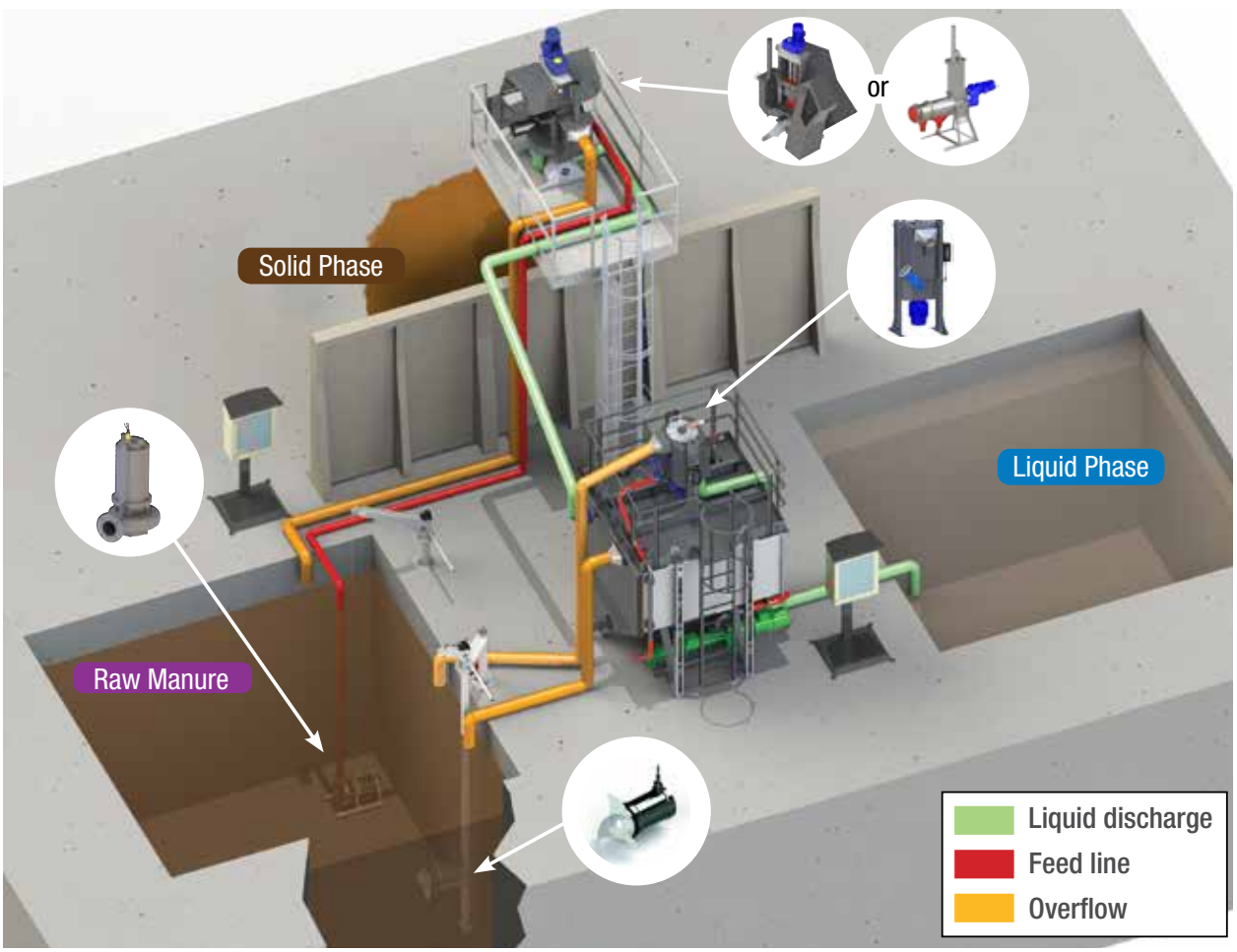

PIG MANURE SEPARATORS

Separators are the core of a **SEPCOM™ Pig** plant as they allow to separate manure into a solid and a liquid phase. With **high performance SINT™ engineering polymer screw flights** and a **stainless steel design**, **SEPCOM™ Pig** is available in three distinct model versions. The choice mainly depends on the required flow rate and the amount of solids present.

SEPCOM™ Pig Vertical INTERNATIONAL PATENT PENDING

The perfect choice for pig manure with low solids content.

- ✓ Never loses the solid plug
- ✓ Stable feeding due to compensator tank
- ✓ Higher separation efficiency than with traditional separators
- ✓ Affordable spare parts



SEPCOM™ Pig Horizontal

Ideal to obtain high solids content in the separated solid phase.

- ✓ Up to 30% separated solids
- ✓ Safe continuous operation due to self-adjusting pressor at solids outlet INTERNATIONAL PATENT
- ✓ Affordable spare parts



MINI-SEPCOM™ Pig Horizontal

The most compact machine of the range, ideal for small amounts of manure.

- ✓ Minimised footprint
- ✓ Safe continuous operation due to self-adjusting pressor at solids outlet INTERNATIONAL PATENT
- ✓ Affordable spare parts



MICRO-FILTRATION

Micro-filtered manure slurry can be used for fertigation, with lower water consumption and avoiding use of chemical fertiliser.

SEPCOM™ MFT Micro-Filter INTERNATIONAL PATENT PENDING

The **SEPCOM™ MFT Micro-Filter** is used to fine-screen the liquid phase of a previous solids-liquid separation process.

- ✓ **High filtration efficiency due to stainless steel screen down to 25µm (0.025mm)**
- ✓ **Self-cleaning**
- ✓ **Low operating costs**



ACCESSORIES

Prior to separation and micro-filtration, raw pig manure may contain lumpy solids or fibre that could disrupt the regular plant flow. In this case, a submersible chopper pump and an agitator are an excellent solution.

SEPCOM™ WSA Submersible Agitator

The **SEPCOM™ WSA Submersible Agitator** stirs up the raw manure to be treated by the separator.

- ✓ **Excellent blending performance**
- ✓ **Prevents from deposits forming on the bottom of the collecting tank and from potential clogging of pump and separator**



SEPCOM™ WSP Submersible Chopper Pump

Thanks to an integrated cutting system, **SEPCOM™ WSP Submersible Chopper Pumps** can convey liquids containing lumpy solid particles or fibre.

- ✓ **Two functions: shredding and pumping**
- ✓ **The perfect solution for difficult operating conditions**



Technical Features and Overall Dimensions

SEPCOM™ Pig Vertical Pig Manure Separator

INTERNATIONAL PATENT PENDING

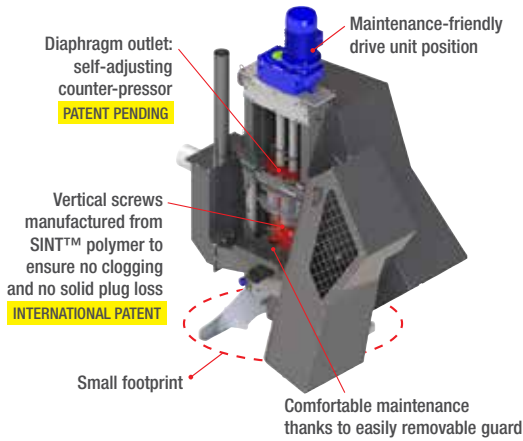

RANGE	Diameter mm	A mm	B mm	H mm	Power kW	Weight kg	Max. Throughput m³/h *
SEPPIGV21503	150	1,320	1,690	2,340	4.0	460	20
SEPPIGV22003	200	1,500	1,890	2,685	5.5	650	45

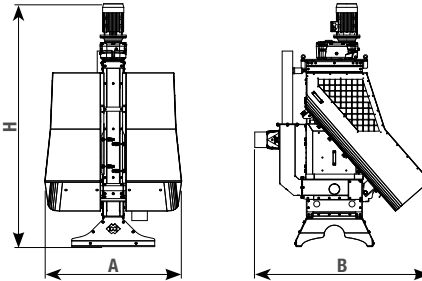

* The flow rate is intended with clean water. Its real value depends on the type of material treated, on configuration of the equipment, as well as use and maintenance conditions.

SEPCOM™ Pig Horizontal Pig Manure Separator

INTERNATIONAL PATENT

Wear-resistant SINT™ polymer screw

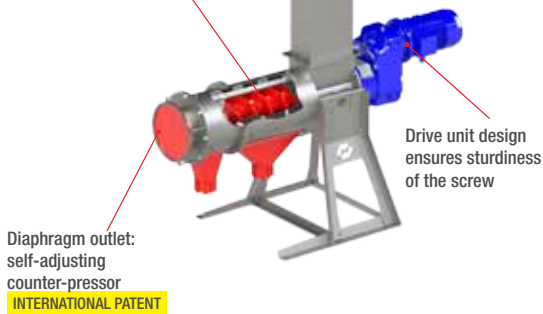

RANGE	Diameter mm	A mm	B mm	H mm	Power kW	Weight kg	Max. Throughput m³/h *
SEPPIGH11502	150	660	1,200	1,800	2.2	137	15
SEPPIGH12602	260	980	1,930	2,770	4.0	485	45
SEPPIGH12603	260	980	2,230	2,770	5.5	535	65

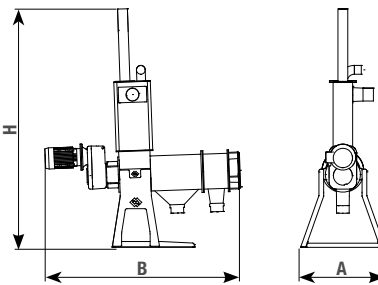

* The flow rate is intended with clean water. Its real value depends on the type of material treated, on configuration of the equipment, as well as use and maintenance conditions.

SEPCOM™ MFT Micro-Filter

INTERNATIONAL PATENT PENDING

Filter screen for particles down to 25µm (0.025mm)

SINT™ polymer screw

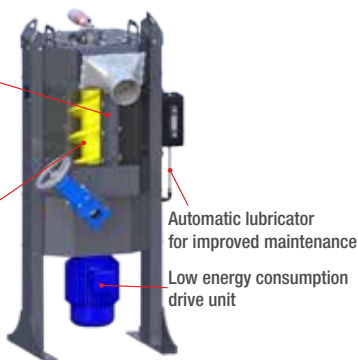

RANGE	Diameter mm	A mm	B mm	H mm	Power kW	Weight kg	Max. Throughput m³/h *
SEPCOM MFT260	260	870	880	1,575	7.5	300	10

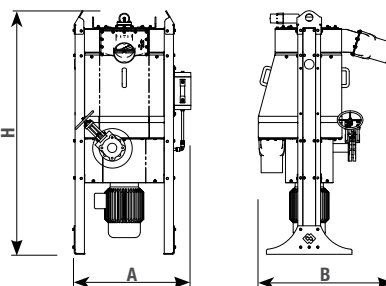

* The flow rate is intended with clean water. Its real value depends on the type of material treated, on configuration of the equipment, as well as use and maintenance conditions.

SEPCOM™ WSA Submersible Agitators

SEPCOM™ WSP Submersible Chopper Pumps



RANGE	Blade Diameter mm	Length mm	Power kW	Weight kg
WSA 15	260	465	1.5	53
WSA 22	320	570	2.2	80
WSA 30	395	605	3.0	104
WSA 40	600	580	4.0	149
WSA 55	600	635	5.5	169
WSA 75	600	690	7.5	195

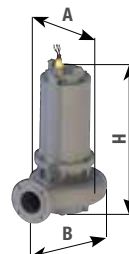

RANGE	Inlet ø mm	Width mm	Length mm	Height mm	Weight kg
WSP 22					73
WSP 30	80	330	400	670	75
WSP 40					76
WSP 55	100	345	440	770	121
WSP 75					127

Application



Ancillary Equipment



HOPPER TANKS
for separator



SEPCOM™ SCP
control panel



COMPACT MICRO-FILTRATION PLANT
Plant complete with
micro-filter and tank



203001527 April 2019 Rights reserved to modify technical specifications.



SEPCOM™



sepcom.wamgroup.com